

## DIATERMO MB 122 AND MB 160 MONO-BIPOLAR - 120 W - 160 W



- 30538 DIATERMO MB 122 VALUE\* - mono-bipolar - 120 W
- 30540 DIATERMO MB 122 - mono-bipolar - 120 W
- 30541 DIATERMO MB 160 - mono-bipolar - 160 W

MB 122 and 160 are HF electrocautery units suitable to perform middle monopolar or bipolar electrocautery.

By selection of the modes of operation they provide pure cut, coagulated cut, forced coagulation, soft coagulation and, with forceps, bipolar coagulation. The use of either split or normal neutral plate is allowed. MB 160 is recommended in case of damp operational fields, for instance mucous, with consequent need to have reserve of usable power. For these reasons, MB 160 is suggested for Gynecological and orthopedic surgery.

**Leading-Edge Technology.** This advanced concept device enables highly professional surgery intervention thanks to ergonomic and safety features derived from high power theatre apparatus.

**Complete safety.** Open Circuit (OC) Alarm warns the user that connection into the neutral plate has not been made or that the cable is disconnected or the neutral plate is not in contact with the patient. The alarm is signaled by an intermittent beep together with a flashing red light on the front panel. In this case HF emission for cut and coagulation operation is switched off.

**OVT Alarm.** The unit includes an internal circuit protection warning when the current delivery is exceeding.

### STANDARD ACCESSORIES

- MB single-use two button handle
- MB operative foot-switch 30577 (usable as alternative to handle) (30540-1 only)
- MB flat neutral plate with cable 30564 (30540-1 only) Power cable 2 m
- Kit of 6 (MB 122) or 10 (MB 160) short autoclavable electrodes, diam. 2.4 mm
- User manual: available in GB, ES, IT, FR, PL

\*Does not include foot switch and MB flat neutral plate with cable

### TECHNICAL SPECIFICATIONS

	MB122	MB160	Crest Factor
Minimum preselectable power	0	0	
Level step	1	1	
Maximum output power CUT (W)	120 250Ω	160 250Ω	1.5
Maximum output power BLEND (W)	90 200Ω	120 200Ω	2.1
Maximum output power COAG FORCED (W)	80 150Ω	100 150Ω	2.0
Maximum output power COAG SOFT (W)	60 100Ω	80 100Ω	1.7
Maximum output power BIPOLAR (W)	40 100Ω	60 100Ω	1.5
Working frequency	600 kHz	600 kHz	
Weight kg	7	7	
Size LxHxD mm	260x110x265	260x110x265	
Operating voltage (switchable)	115 -230	115 -230	
Mains frequency (Hz)	50-60	50-60	
Fuses 230Vac (5x20) TIMED	2x 3.15A	2x 3.15A	
Fuses 115Vac (5x20) TIMED	2x 6.3A	2x 6.3A	
Electrical input power (VA)	300	350	
Electrical input current (230 Vac) (A)	1.3	1.5	
Electrical input current (115 Vac) (A)	2.6	3	
Five steps adjustable sound level (from 55- to 75dBA)	•	•	
Self-check	•	•	
Power accuracy output warning	•	•	
Split or not split patient plate allowed	•	•	
Last working condition storing	•	•	
Electrical Class (EN60601 - 1)	I CF	I CF	
MDD 93/42/EEC Class	II b	II b	
Patient circuit	F	F	

## MONOPOLAR ELECTROSURGERY UNIT - 50 W



- 30516 DIATERMO 106 - 50W - monopolar

This HF electrocautery unit is particularly suitable for small operations and is recommended for dentistry, first aid and dermatology work. It offers precision of cut and immediate coagulation and give excellent results in a wide range of applications: from uterine coagulation to microcoagulation in dermatology. The modes of operation, CUT, COAG or



### TECHNICAL SPECIFICATIONS

Output power: CUT	50 W/400 ohm
COAG	40 W/400 ohm
BLEND	45 W/400 ohm
Working frequency:	600 kHz ±10%
Size: 180x180xh 100 mm	Weight: 2.8 kg
Operating Voltage: 115/230 V - 50/60 Hz switchable	
Electric input power: 90 VA	Fuse: 2x1 AT
Alarm for overheating	Footswitch operating
Norms: EN60601-1 Class I CF, EN60601-2-2 93/42/EEC (Class IIb)	
Made in Italy	Warranty: 12 months

### STANDARD ACCESSORIES

- KIRKY single-use handle without buttons
- Standard foot-switch (30577)
- Flat neutral plate with cable (30564)
- Kit of 6 short autoclavable electrodes, Ø 2.4 mm, length 5 cm
- Power cable 2 m - Schuko plug
- User manual: available in GB, IT, ES, FR

BLEND, can be easily selected by a switch on the front panel. The complete isolation between patient and the unit and strict respect of international norms guarantee total safety.

# MONO-BIPOLAR ELECTROSURGICAL UNITS 80W, 120W, 160W



CASUALTY SURGERY  
 PEDIATRIC SURGERY\*  
 PLASTIC SURGERY\*  
 VASCULAR SURGERY  
 DERMATOLOGY  
 FIRST AID  
 OTORHINOLARYNGOLOGY  
 UROLOGY\*  
 GYNAECOLOGY  
 VETERINARY  
 DENTISTRY\*\*  
 \*Diatermo MB160 only  
 \*\*Diatermo MB120 only



- 30627 DIATERMO MB 80D - mono-bipolar - 80 W
- 30628 DIATERMO MB 120D - mono-bipolar - 120 W
- 30629 DIATERMO MB 160D - mono-bipolar - 160 W

Diatermo MB are high frequency electrosurgical units suitable for minor and medium surgery. MB allow pure CUT, cut-coagulation BLEND, superficial coagulation FORCED COAG, deep coagulation in absence of necrosis SOFT COAG and, with forceps, BIPOLAR coagulation. The digital reading of delivered power and the monitoring of operative function by microcontroller guarantees absolute reliability of working conditions. MB allow a highly professional surgery through ergonomic and safety features. The connection of neutral electrode is constantly monitored. Safety control of patient/plate contact using split neutral electrode. Possibility to control the output functions and the delivery of output power by the handle, allows the surgical operation without diverting attention from the surgical field.

- Features:
- minimum invasive surgery
  - possibility to use bipolar forceps
  - possibility to use split neutral electrodes
  - memorization of the last used settings
  - power activation by pedal and/or handle
  - digital adjustment and indication of the output power
  - adjustment of the acoustic indicator intensity.



TECHNICAL SPECIFICATIONS			
	MB 80D	MB 120D	MB 160D
Max output power CUT	80 W-250 Ω	120 W-250 Ω	160 W-250 Ω
Max output power BLEND	60 W-250 Ω	90 W-200 Ω	120 W-200 Ω
Max output power FORCED COAG	50 W-150 Ω	80 W-150 Ω	100 W-150 Ω
Max output power SOFT COAG	40 W-100 Ω	60 W-100 Ω	80 W-100 Ω
Max output power BIPOLAR	30 W-100 Ω	40 W-100 Ω	60 W-100 Ω
Working frequency	600 kHz	600 kHz	600 kHz
Patient circuit	F	F	F
Selectable input voltage	115 - 230 Vac	115 - 230 Vac	115 - 230 Vac
Mains frequency	50 - 60 Hz	50 - 60 Hz	50 - 60 Hz
Electrical input power	230 VA	300 VA	350 VA
Size WxHxD mm	254x104x288	254x104x288	254x104x288
Weight	5 kgs	5 kgs	5 kgs
Controls:	Patient/Plate circuit monitoring, Output power monitoring, Self check control		
Safety:	EN60601-1, EN60601-1-2, EN60601-2-2, Electrical Class: I CF, MDD 93/42/EC Class: II b		

**STANDARD ACCESSORIES**

MB single use two button handle  
 Waterproof foot-switch 30577 (usable as alternative to handle)  
 MB flat neutral plate with cable (30564)  
 Kit of 10 short autoclavable electrodes, diam. 2.4 mm. Power cable: 2 m  
 User manual: GB, IT, available on request FR, ES, PL

# MONOPOLAR ELECTROSURGERY UNITS 50W AND 80W



DENTISTRY  
 DERMATOLOGY  
 OUT PATIENT SURGERY  
 FIRST AID  
 VETERINARY\*  
 VASCULAR SURGERY\*  
 \*Diatermo 80 only

- 30625 DIATERMO 50 - monopolar
- 30626 DIATERMO 80 - monopolar

Diatermo 50 and 80 are radiofrequency electrosurgical units suitable for minor monopolar surgery. Diatermo 50 through the function selection makes pure cut, cut coagulation (CUT 1 - CUT 2) and pure coagulation possible. Diatermo 80 has a multifunction selector which makes cutting (CUT), cut coagulation (BLEND), coagulation (COAG) and micro-coagulation (MICRO) possible. The one-board microcontroller and digital display guarantee high safety and reliability under any conditions. They offer outstanding professional surgical results due to their ergonomic and superior safety features.



TECHNICAL SPECIFICATIONS		
	50	80
Max output power CUT	50 W-400 Ω	80 W-400 Ω
Max output power CUT/COAG1	45 W-400 Ω	-
Max output power CUT/COAG2	40 W-400 Ω	-
Max output power BLEND	-	60 W-400 Ω
Max output power COAG	40 W-400 Ω	50 W-400 Ω
Max output power MICRO	-	20 W-600 Ω
Working frequency	600 kHz	700 kHz
Patient circuit	F	F
Selectable input voltage	115 - 230 Vac	115 - 230 Vac
Mains frequency	50 - 60 Hz	50 - 60 Hz
Electrical input power	200 VA	230 VA
Size WxHxD mm	190x85x239	190x85x239
Weight	2.5 kg	2.5 kg
Controls:	Patient/Plate circuit monitoring, Output power monitoring, Self check control	
Safety:	EN60601-1, EN60601-1-2, EN60601-2-2, Electrical Class: I CF, MDD 93/42/EC Class: II b	

**STANDARD ACCESSORIES**

Single use handle  
 Waterproof foot-switch (30577)  
 MB flat neutral plate with cable (30564)  
 Kit of 6 short autoclavable electrodes, Ø 2.4 mm, length 5 cm (30501/2/4/7/9/10) see page 187  
 Power cable 2 m - Schuko plug  
 User manual: GB, IT, available on request FR, ES

# MONO-BIPOLAR ELECTROSURGICAL UNIT 200W



- OUTPATIENT SURGERY
- ENDOSCOPY
- FIRST AID
- GASTROENTEROLOGY
- GENERAL SURGERY
- GYNAECOLOGY
- NEUROSURGERY
- ORTHOPEDICS
- OTORHINOLARYNGOLOGY
- PEDIATRIC SURGERY
- PLASTIC SURGERY
- PNEUMOLOGY
- UROLOGY
- VASCULAR SURGERY
- VETERINARY



**• 30630 DIATERMO MB 200D - 200 W**

MB 200D is a high frequency electrocautery equipment suitable for light and medium surgery, allows minimally invasive surgical procedure of resection, evaporation and coagulation. MB 200D allows pure CUT, Cut-Coagulation BLEND, incision with reduced production of eschar ENHANCED, superficial coagulation FORCED COAG, deep coagulation in absence of necrosis SOFT COAG and BIPOLAR coagulation. Digital reading of delivered power and surveillance through microcontroller of the operational functions, assure absolute reliability of working conditions. MB 200D allows a highly professional surgery through ergonomic and safety features. The connection of neutral electrode is constantly monitored. Safety control of patient/plate contact using split neutral electrode. Possibility to control the output functions and the delivery of output power by the handle, allows the surgical operation without diverting attention from the surgical field.

- patient-to-plate contact control
- split return electrode use

- minimally invasive surgical treatment allowed
- monopolar and Bipolar independent output
- auto Start/Stop in Bipolar Coag
- working condition planning
- power delivery by pedal and/or handle
- digital regulation and indication of the output power
- sound level control
- adjustable power increment



**STANDARD ACCESSORIES**

- MB two-button autoclavable handle (30536)
- Waterproof MB foot-switch (30577)
- MB flat neutral metal plate with cable (30564)
- Kit 10 short standard electrodes, diam. 2.4 mm
- 3 needle + 3 blade + 3 ball electrodes 7 cm
- Power cable 5 m
- Manual: available in GB, IT

**TECHNICAL SPECIFICATIONS**

Maximum output power CUT	200W - 250Ω
Maximum output power ENHANCED	120W - 250Ω
Maximum output power BLEND	120W - 200Ω
Maximum output power FORCED COAG	150W - 150Ω
Maximum output power SOFT COAG	90W - 100Ω
Maximum output power BIPOLAR COAG	80W - 50Ω
Working frequency	600 kHz
Patient circuit	F
Mains voltage	115-230 Vac
Mains frequency	50-60 Hz
Electrical input power	350 VA
Size WxHxD mm	370x144x319
Weight	6 kgs
Controls:	Patient/Plate circuit monitoring, Output power monitoring, Self check control
Safety:	EN60601-1, EN60601-2-2, EN60601-1-2, EN60601-2-2, Electrical Class: I CF, MDD 93/42/EC Class: II b

# DIATERMO MB 200 - MONO-BIPOLAR - 200W



**• 30542 DIATERMO MB 200 - 200 W**

DIATERMO MB200 is a HF electrocautery unit suitable to perform middle monopolar or bipolar electrocautery. The available waveforms and peak voltage value, as well as the accurate HF leakage current operation for polypectomy, TURP, intrauterine resections, endometriosis excision, etc. The units allow the accurate preset of the output power with as low as 1 Watt resolution and to perform coagulation by high crest factor current, to get an elevated thermal effect, as well as with low voltage low crest factor current, to get coagulation in absence of carbonization. Ten different programs related to ten different operative conditions could be stored and easily recalled by the surgeon. The use of either split or normal neutral plates are allowed. A special electronic circuit (Skin Plate Electronic Control) continuously checks if the plate is safely connected to the patient and detects unwanted short circuit in the connecting cable. An over time warning (OVT) is provided to prevent excessive heating of the tissue around the surgical target due to too long current delivery time.

**DIATERMO MB 200 - STANDARD ACCESSORIES**

- MB two-button autoclavable handle (30536)
- MB waterproof foot-switch 30577 (usable in alternative to handle)
- MB flat neutral metal plate with cable (30564)
- Kit 10 short standard electrodes, diam. 2.4 mm
- Power cable 2 m
- Manual: available in GB, IT



**TECHNICAL SPECIFICATIONS**

Maximum output power CUT (W)	200	250Ω	1.5	Weight kg	8
Maximum output power CUT 90% (W)	200	250Ω	1.6	Size LxHxD mm	360x150x265
Maximum output power CUT 80% (W)	200	250Ω	1.7	Selectable mains power(Vac)	115 -230
Maximum output power CUT 70% (W)	200	250Ω	1.8	Mains frequency (Hz)	50-60
Maximum output power BLEND (W)	120	200Ω	2.1	Fuses 115Vac - 230Vac (5x20) TIMED	2x 6.3A - 2x 3.15A
Maximum output power COAG FORCED (W)	150	150Ω	2.0	Power accuracy output warning system	•
Maximum output power COAG SOFT (W)	90	100Ω	1.7	Split or not split patient plate allowed	•
Maximum output power BIPOLAR COAG (W)	100	100Ω	1.5	Electrical Class (EN60601 - 1)	I CF
Maximum output power BIPOLAR CUT (W)	120	250Ω	1.5	MDD 93/42/EEC Class	II b
Working frequency	600 kHz			Patient circuit	F
				Duty cycle (action/pause) in seconds	10/30

# MONOPOLAR AND BIPOLAR ELECTROSURGICAL UNITS 120W AND 200W



- OUTPATIENT SURGERY
  - DERMATOLOGY
  - VASCULAR SURGERY
  - GYNECOLOGY
  - DENTAL\*
  - OTORHINOLARYNGOLOGY
  - PEDIATRIC SURGERY\*\*
  - FIRST AID
  - PLASTIC SURGERY\*\*
  - ENDOSCOPY
  - OPHTHALMOLOGY
  - NEUROSURGERY\*\*
  - PODIATRY\*\*
  - PNEUMOLOGY\*\*
  - UROLOGY\*\*
  - VETERINARY
  - GASTROENTEROLOGY
  - ORTHOPEDICS\*\*
- \* Diatermo MB 120 only  
\*\*Diatermo MB 200 only

- 30631 DIATERMO MB 120 FLASH
- 30633 DIATERMO MB 200 FLASH

MB FLASH are a High Frequency ElectroSurgical equipment suitable for precision monopolar and bipolar surgery and micro-surgery without tissue alterations.

MB FLASH allow surgical treatments with programmable timer operations up to milliseconds or with traditional mode.

MB FLASH allow pure CUT, cut-coagulation BLEND, incision with reduced production of eschar ENHANCED, superficial coagulation FORCED COAG, deep coagulation in absence of necrosis SOFT COAG and BIPOLAR coagulation. Digital reading of delivered power and the surveillance through microcontroller of the operational functions, assure absolute reliability of the working conditions.

MB FLASH allow a highly professional surgery through ergonomic and safety features.

Connection of neutral electrode is constantly monitored. Safety control of patient/plate contact using split neutral electrode. Possibility to control the output functions and the delivery of output power by handle, allows surgical operation without diverting attention from the surgical field.

- Features:
- patient to plate contact control
  - split return electrode use allowed
  - minimally invasive surgical treatment allowed
  - Monopolar and Bipolar independent output
  - auto Start/Stop in Bipolar Coag
  - working condition planning
  - power delivery by pedal and/or handle
  - digital regulation and indication of the output power
  - sound level control
  - adjustable power increment
  - RF power pulse emission time setting
  - RF power pulse interval setting



### TECHNICAL SPECIFICATIONS

	MB 120F	MB 200F
Max output power CUT	120 W-250 Ω	200 W-250 Ω
Max output power BLEND	90 W-200 Ω	120 W-200 Ω
Max output power ENHANCED	90 W-250 Ω	120 W-250 Ω
Max output power FORCED COAG	80 W-150 Ω	150 W-150 Ω
Max output power SOFT COAG	60 W-100 Ω	90 W-100 Ω
Max output power BIPOLAR COAG	60 W-50 Ω	80 W-50 Ω
Working frequency	600 kHz	600 kHz
RF power pulse emission time	10ms - 30sec	10ms - 30sec
RF power pulse interval	1 - 9	1 - 9
Patient circuit	F	F
Selectable input voltage	115 - 230 Vac	115 - 230 Vac
Mains frequency	50 - 60 Hz	50 - 60 Hz
Electrical input power	300 VA	350 VA
Size WxHxD mm	370x144x319	370x144x319
Weight	6 kg	6 kg
Controls: Patient/Plate circuit monitoring, Output power monitoring, Self check control		
Safety: EN60601-1, EN60601-1-2, EN60601-2-2, Electrical Class: I CF, MDD 93/42/EC Class: II b		

### STANDARD ACCESSORIES

- MB two-button autoclave handle (30536)
- Waterproof MB footswitch (30577)
- MB flat neutral plate with cable (30564)
- 2 disposable ground pads (30562)
- Kit 10 short standard electrodes Ø 2.4 mm
- 3 needle + 3 blade + 3 ball electrodes 7 cm
- Power cable 5m
- Microsurgery handle (30552)
- Microsurgery needles 10 pieces
- Manual: GB, IT



# ELECTRODEPILATOR

- 28340 ELECTRO-DEPILATOR 400

This device ensures a definitive depilation with thermolitic method. It delivers a current of radiofrequency to cause the heating and consequent coagulation of the papilla, reached through the introduction of a needle into the follicle of the hair. Provided with highly reliable electronic integrated components, with RF intensity adjustable with continuity and luminous working signal.

It comes complete with footswitch, handpiece for depilation, depilation needle and power cable (2 m).

### TECHNICAL SPECIFICATIONS

RF output frequency: 1.9 ±10% MHz
Modulation: sinusoidal
Maximum output power: 7 ±2Watt
Size: 260x265xh 110 mm      Weight: 4 kg
Operating voltage: 115/230 V - 50/60 Hz switchable
Norms: CEI 62-39    Class: I-BF

- 30552 HANDPIECE FOR DEPILATION
  - 30577 FOOTSWITCH
- Depilation or microsurgery needles see page 187



# HOSPITAL HF ELECTROSURGICAL UNITS 240 AND 380 WATT



**30690** CONTEMPORARY DUAL MODE MB 240 and 380 can be used in the same time in monopolar mode (by handle) and bipolar mode (by footswitch) A special electronic circuit (Skin Plate Electronic Control) continuously warns the plate to patient contact safety and unwanted short circuit in the connecting cable

- 30690 DIATERMO MB 240
- 30692 DIATERMO MB 380

These HF electrocautery units can be used to execute monopolar and bipolar surgery when high precision and reliability are essential, as in the endoscopic surgery.

**EASY TO USE**

Graphic icons allow an easy selection of the operation mode. All operating conditions and selected output controls are represented by bright digital indications.

**CUT**

The monopolar cut can be performed by pure sine current to obtain an incision with a minimum damage for the adjacent tissues and sure recovery for first intention.

Two different modes of modulation allow to reduce bleeding during monopolar cut. In the bipolar mode the cut can be effected by pure sine current.

**HEMOSTASIS**

When the surgical action requires the obliteration of a blood vessel the availability of currents with different coagulative powers enables this type of work both with monopolar and bipolar surgery.

**FULGURATION**

When it is necessary to cause a superficial necrosis of wide areas, protecting the deeper tissues, a special coagulant current that dehydrates the superficial layer of the tissue and reduces the possibility to damage those beneath is available for the operation.

**OUTPUT CONTROL**

Output power levels are adjustable through incremental

encoders that allow the exact pre-sets and repetition of the values. The output function is linearized and controlled by ultra-modern electronic micro-controllers which will interrupt power if any alarm condition happens.

**SAFETY OF USE**

Circuits dedicated to the safety of operator and patient are the priority. This ensure the leakage current is kept well under the international requirements values, whatever the output condition. Monopolar and bipolar output circuits are completely floating and the use of the defibrillator is allowed while the reference plate patient is connected.

**RELIABILITY**

DIATERMO MB uses all solid state electronic circuits and is made with interchangeable units for a fast and effective maintenance. Automatic control circuits protect the units from damage also in case of repeated improper use.



**TECHNICAL SPECIFICATIONS DIATERMO MB 240/DIATERMO MB 380**

Activation devices	Working frequency	Max power	Peak to peak voltage	Load resistance
Bipolar: footswitch	475 kHz	240/MB 380	1.4 kV	300 Ohm
Dual: bipolar - footswitch monopolar - manual		225W/340W		
Monopolar: footswitch manual	525 kHz	200W/300W	1.4 kV	300 Ohm
Mains: 115/230 Vac 50-60 Hz		150W/225W		
Absorption: 800 VA		100W/150W	1.4 kV	300 Ohm
Class I CF		80W		
Weight: 15 kg		90W	0.5 kV	100 Ohm
Size: 370x470xh 150 mm				
Warranty: 12 months (accessories not included)				
Norms: IEC 601-2-2 - IEC 601-1 CE, 93/42/EEC				

**STANDARD ACCESSORIES**

- 1 - Power supply cord SIEM-CEE 5 m
- 1 - Two-button autoclavable handle (30536)
- 5 - Two-button single use handle
- 1 - Cable for disposable plate
- 5 - Disposable plate
- 1 - Water proof double foot switch
- 3 - Short, general surgery blade electrode
- 3 - Long, general surgery blade electrode
- 3 - Short, general surgery needle electrode
- 3 - Short, general surgery ball electrode
- 1 - User manual (IT, GB, ES)
- 1 - Service manual (IT, GB)

## LAPAROSCOPIC ELECTRODES

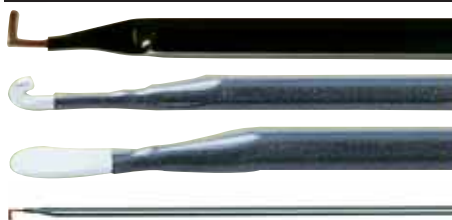

30605

30606

30607

Laparoscopic electrodes without suction for use with Diatermo MB 240/250/300/380/400 with connecting cable 4 mm (30609)

30605

GIMA code	LAPAROSCOPIC ELECTRODES
30605	L-Hook electrode - 36 cm
30606	J-Hook electrode - 36 cm
30607	Spatula electrode - 36 cm
30609	Monopolar cable - 4 mm - M - F

To generator

# HIGH POWER ELECTROSURGICAL UNITS 300 AND 400 WATT



30635

- 30634 DIATERMO MB 300D
- 30635 DIATERMO MB 400D

DIATERMO MB300D and MB400D are high frequency electro-surgical equipments suitable to deliver current for monopolar cut and coagulated cut (with different levels of coagulation), bipolar cut and coagulation.

**TWIN OPERATIVE ACTIVITY**

- two output channels for monopolar cutting
- two independent setting and output channels for the most frequent monopolar coagulation

**CONTROLLED CUTTING PROCEDURES**

- enhanced cutting current for eschar free incision
- cutting current with selectable coagulating property for bleeding controlled dissection
- low capacitive coupling by slow BLEND current for endoscopic procedures

**TWIN CONTROLLED COAGULATION PROCEDURES**

- SPEEDY coagulation and DEEP coagulation available to two operators
- SPRAY coagulation by hand switch or foot switch controls

**EXTENSIVE BIPOLAR FEATURES**

- bipolar cutting current with selectable bleeding control
- slow BLEND cutting current

- automatic Start/Stop coagulation functions

**SURGEON AND PATIENT TOTAL SAFETY**

- acceptability of contact impedance between patient body and return electrode continuously monitored by Skin Plate Electronic Control (SPEC)

- H.F. Leakage currents continuously monitored

- mains fluctuation automatically compensated before delivery of HF power

**PERSONALIZED PROCEDURES**

- independent choice of coagulation currents and power levels by each of two operators

- up to 10 procedures can be configured and re-called

**EXTENSION DRIVER AND INTERLOCK SIGNALS**

- driven output connection to external Argon Plasma unit and Smoke Evacuator unit

**AUTOMATIC SELF DIAGNOSIS**

- automatic diagnostic control of the complete functionality of electronic unit and connected accessories with coded report of failures



30634

- SUITABLE IN:
- OUTPATIENT SURGERY
  - GENERAL SURGERY
  - PAEDIATRIC SURGERY
  - PLASTIC SURGERY
  - THORAX SURGERY
  - VASCULAR SURGERY
  - DERMATOLOGY
  - ENDOSCOPY
  - GASTROENTEROLOGY
  - GYNAECOLOGY
  - NEUROSURGERY
  - ORTHOPEDICS
  - OTORHINOLARINGOLOGY
  - PNEUMOLOGY
  - UROLOGY
  - VETERINARY

**STANDARD ACCESSORIES**

- 1 - Power supply cord 5 m
- 1 - Two-button autoclavable handle (30536)
- 5 - Two-button cold sterilizable handle (30551)
- 1 - Cable for flat plate (30559)
- 5 - Rem disposable ground pads (30493)
- 2 - HP double Water proof foot switch
- 3 - Short, general surgery blade electrode 7 cm
- 3 - Long, general surgery blade electrode 16 cm
- 3 - Short, general surgery ball electrode Ø 4 mm, 6 cm
- 1 - Electrode brush
- 1 - User manual (IT, GB)
- 1 - Service manual (IT, GB)

**TECHNICAL SPECIFICATIONS MB300/MB400**

	MB 300	MB 400
Maximum out power monopolar pure CUT	300 W - 300 Ω	400 W - 300 Ω
Maximum out power monopolar cut-coag CUT80%	250 W - 300 Ω	350 W - 300 Ω
Maximum out power monopolar cut-coag CUT60%	200 W - 300 Ω	250 W - 300 Ω
Maximum out power monopolar cut-coag CUT40%	150 W - 300 Ω	200 W - 300 Ω
Maximum out power monopolar cut ENHANCED	200 W - 500 Ω	250 W - 500 Ω
Maximum out power monopolar cut-coag BLEND	200 W - 300 Ω	250 W - 300 Ω
Maximum out power monopolar coag SPEEDY	100 W - 500 Ω	120 W - 500 Ω
Maximum out power monopolar coag DEEP	100 W - 200 Ω	120 W - 200 Ω
Maximum out power monopolar coag SPRAY	70 W - 2000 Ω	100 W - 2000 Ω
Maximum out power monopolar coag SPRAY ARGON	70 W - 2000 Ω	100 W - 2000 Ω
Maximum out power bipolar CUT	95 W - 150 Ω	95 W - 150 Ω
Maximum out power bipolar cut-coag CUT80%	95 W - 150 Ω	95 W - 150 Ω
Maximum out power bipolar cut-coag CUT60%	95 W - 150 Ω	95 W - 150 Ω
Maximum out power bipolar cut-coag CUT40%	60 W - 150 Ω	60 W - 150 Ω
Maximum out power bipolar cut-coag BLEND	90 W - 150 Ω	90 W - 150 Ω
Maximum out power bipolar cut-coag BLEND	70 W - 100 Ω	70 W - 100 Ω
Working frequency monopolar / bipolar	425 kHz / 525 kHz	425 kHz / 525 kHz
Patient circuit	F	F
Selectable input voltage	115-230 Vac	115-230 Vac
Mains frequency	50-60 Hz	50-60 Hz
Electrical input voltage	1000 VA	1000 VA
Size WxHxD mm	470x150x400	470x150x400
Weight	17.5 Kgs	17.5 Kgs
Controls: Patient/Plate circuit monitoring, Output power monitoring, Self check control		
Safety: EN60601-1, EN60601-1-2, EN60601-2-2, Electrical Class: I CF, MDD 93/42/EC Class: II b		



## LOOP ELECTRODES Ø 2.4 mm



GIMA code	Reference number	LOOP ELECTRODES - Ø 2.4 mm autoclavable at 121° C	Shaft length	Electrode width	Electrode depth
30686	50	Square loop electrode	13 cm	10 mm	8 mm
30687	51	Loop electrode	13 cm	15 mm	8 mm
30688	52	Loop electrode	13 cm	20 mm	10 mm

## ELECTRODES AND HANDLE Ø 4 mm

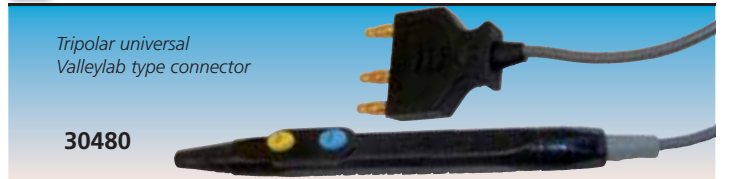

- 30480 AUTOCLAVABLE MB HANDLE Ø 4 mm - 100 times Autoclavable handle up to 100 times for Ø 4 mm shaft electrodes with 3 m silicone cable and blade electrode.
  - 30482 NEEDLE ELECTRODE Ø 4 mm
  - 30483 BLADE ELECTRODE Ø 4 mm
  - 30484 BALL ELECTRODE Ø 4 mm
- S/S electrodes autoclavable 100 times. Sold in box of 5. Length 5.5 cm.

## AUTOCLAVABLE ELECTRODES Ø 2.4 mm

GIMA code	Reference number	AUTOCLAVABLE ELECTRODES Ø 2.4 mm	Reference number	GIMA code
length 5 cm		minimum order: 6 pcs.		
30501	1	Electrode wire 0.2 - straight	21	30521
30502	2	Electrode wire 0.2 - angled 45°	22	30522
30503	3	Electrode bend - Ø 4 - straight	23	30523
30504	4	Electrode bend - Ø 8 - straight	24	30524
30505	5	Electrode hook - angled 45°	25	30525
30506	6	Electrode wire 1 mm.- angled 45°	26	30526
30507	7	Electrode straight slip-knot - straight	27	30527
30508	8	Electrode angled slip-knot - straight	28	30528
30509	9	Electrode ball point - Ø 3 mm - angled 45°	29	30529
30510	10	Electrode ball point - Ø 3 mm - straight	30	30530
30500	SET	Set of 10 electrodes	SET	30531
length 7 cm		minimum order: 10 pcs.		
30511	15	Needle electrode	35	30532
30512	16	Blade electrode	36	30533
30513	17	Ball electrode	37	30534

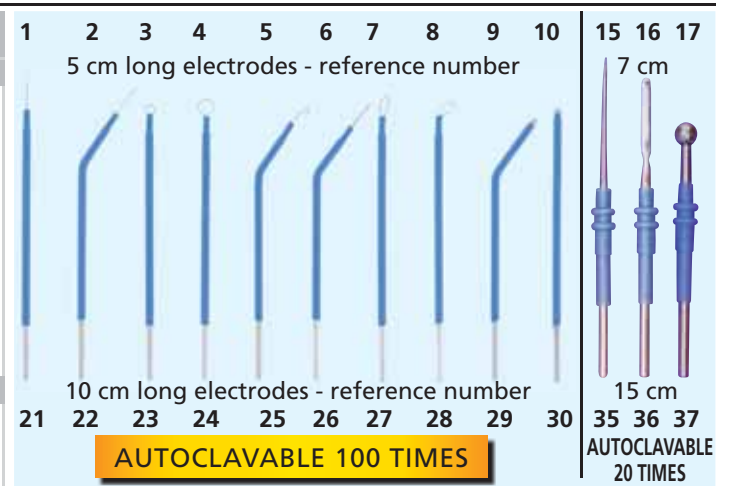

## SINGLE USE STERILE ELECTRODES Ø 2.4 mm

GIMA code	Reference number	SINGLE USE ELECTRODES Ø 2.4 mm	Reference number	GIMA code
length 7 cm		Sterile electrode - box of 24		
30670	13	Needle electrode - sterile electrode	33	30674
30671	11	Blade electrode - sterile	31	30675
30672	12	Ball Ø 4 mm electrode - sterile	32	30676
-		Sterile electrode - box of 10		
-		Loop electrode - 15 mm x 8 mm		
		length 15 cm	34	30678
		length 13 cm		



## NON-STICK SINGLE USE STERILE ELECTRODES Ø 2.4 mm

GIMA code	NON-STICK SINGLE USE ELECTRODE Ø 2.4 mm	Length
30420	Blade electrode - sterile	7 cm
30422	Blade electrode - sterile	10 cm
30425	Needle electrode - sterile	10 cm
30429	Ball electrode - sterile	13 cm

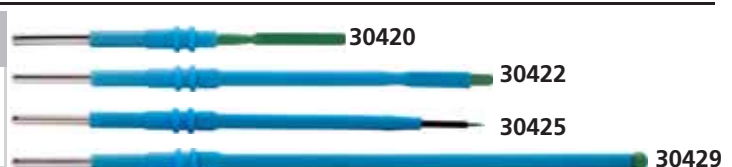

## BALLET STERILE DISPOSABLE ELECTROLYSIS NEEDLES

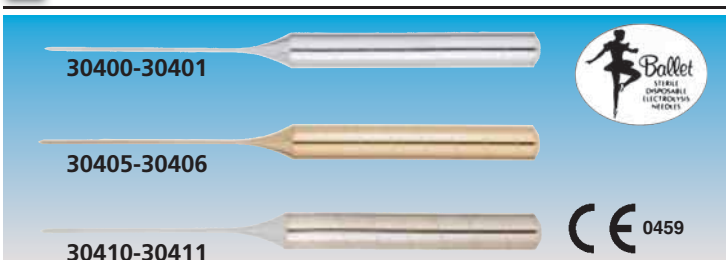

**Ballet needles**  
The Ballet needle is manufactured with both a precise point and a mirror-like surface polish. The rounded tapered point of the needle will assist the electrologist in locating the follicle opening and upon insertion the needle will slide smoothly and accurately to the base of the follicle.

**Stainless steel needles**  
Ideal for patients with strong healthy skin who respond well to electrolysis treatment.

**Insulated needles**  
Suggested for patients with high sensitivity to discomforts of electrolysis.

**24 carat gold plated needles**  
For clients who suffer from allergies and sensitive skin.

Stainless steel	Gold plated	Insulated	ELECTROLYSIS NEEDLES - STERILE	Minimum order
30400	30405	30410	K2 needle - 0.055 mm (0.002")	box of 50
30401	30406	30411	K3 needle - 0.075 mm (0.003")	box of 50

## 3-PIN MONOPOLAR HANDLES FOR ELECTRODES Ø 2.4 mm

**VALLEYLAB CONNECTOR HANDLES with 2 "click" push-buttons**  
GIMA autoclavable electrosurgery pencils with CUT-COAG switch have been studied and tested to offer maximum reliability and functionality to the operator. MB handles are provided with a 3 Pin plug Valleylab type fitting all Gima mono-bipolar Diatermo MB (120, 122, 132, 160, 200, 202, 240, 250, 380, 400) and most of bipolar electrosurgical units: Aspen Lab, ES Generator, EMC Statome, Danieli, Braun, Berchtold, Ohmeda, Ritter, Conmed, Eschmann, Bovie, Martin, Kontron, Bard, Birtcher 771, Cobi, Valleylab, Led, Erbe...

### AUTOCLAVABLE HANDLES

- **30554 MB AUTOCLAVABLE HANDLE - 100 times**  
Autoclavable handle with 2 large "click" push-buttons, provided with a 3 meter long silicone cable and a blade electrode. It can be autoclaved up to 100 times (electrode 20 times).
- **30545 MB AUTOCLAVABLE HANDLE - 100 times**  
Same as code 30554 but with a 5 m long silicone cable
- **30550 PRIMA MB AUTOCLAVABLE HANDLE - 60 times**  
Autoclavable handle with 2 large "click" push-button, provided with a 3 meter long silicone cable and a blade electrode. It can be autoclaved up to 60 times.
- **30548 STAR AUTOCLAVABLE HANDLE - 30 times**  
Same as code 30554 but autoclavable up to 30 times (electrode is autoclavable up to 20 times).
- **30539 ORION PLUS AUTOCLAVABLE HANDLE - 100 times**  
Same as 30554, but with a screw clamp locking system ensuring a safe contact and adapting to slightly different electrode diameters. High insulation to prevent liquid damage.
- **30536 SURGEON AUTOCLAVABLE HANDLE - 100 times**  
Autoclavable, waterproof handle with ergonomic grip. Coloured ring that indicates CUT and COAG push buttons. Provided with 3 m cable and blade electrode.

### SINGLE USE HANDLE

- **30551 KIRKY SINGLE-USE HANDLE - STERILE**  
Single-use handle with "click" push-buttons for cut and coag. Includes blade electrode.
- **30553 GIMA SINGLE-USE HANDLE - STERILE**  
Same as 30551 with 3 m cable.



## 1-PIN MONOPOLAR HANDLES FOR ELECTRODES Ø 2.4 mm

### 1 pin plug HANDLES for diatermo 50, 80, 106, 108

These handles are provided with a 1 Pin socket (4 mm) fitting all Gima Diatermo and most of electrosurgical units in the market. These handles **do not have push-buttons**.

- **30515 SURGEON 1 PIN AUTOCLAVABLE HANDLE - 100 times**  
Autoclavable, waterproof handle with ergonomic grip. Provided with 3 m cable and blade electrode
- **30519 AUTOCLAVABLE 50-80-106-108 HANDLE**  
Autoclavable handle **without buttons**, provided with a 3 meter long cable and a blade electrode. It can be autoclaved up to 50 times.
- **30518 KIRKY SINGLE-USE 50-80-106-108 HANDLE - STERILE**  
Single-use handle without button with blade electrode with 4 mm PIN connection.

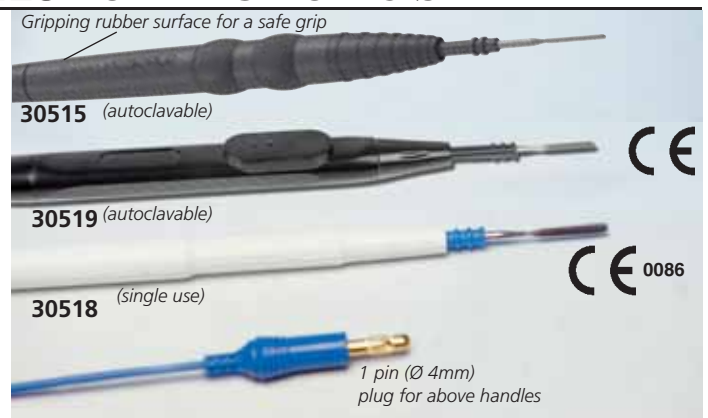

## HANDLES FOR ELECTROLYSIS NEEDLES

Needle handles for all GIMA Diatermo and electro-depilators

- **30552 HANDLE for electrolysis needles**
- **30415 PROFESSIONAL HANDLE for electrolysis needles**  
see electrolysis needles at page 187



## ELECTRODE BRUSHES

- **30537 ELECTRODE BRUSH - 50x50 mm**  
Disposable sterile radiopaque abrasive tip cleaner pad. Box of 100

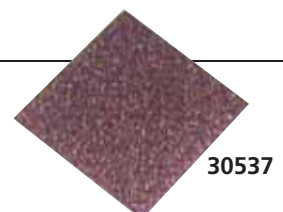



## BIPOLAR CABLES FOR MAJOR BRANDS

Quality highly flexible silicone bipolar cables. Autoclavable at 134°C for minimum 20 times. 3 m long (10").

Recommended ETO sterilization for max extended life. Suitable for most generators, with connector for European or US forceps.

<p><b>30642</b> • <b>30642 BIPOLAR CABLE ADAPTOR</b></p>	<p>Connector to forceps</p>	<p>Connector to electro-surgical unit</p>	<p>Connector to forceps</p>	<p>Connector to electro-surgical unit</p> <p>Pin distance 29 mm</p>						
	GIMA Code	<b>30632</b>	<b>30618</b>	<b>30640</b>	<b>30637</b>	<b>30643</b>	<b>30618+ 30642</b>	<b>30617</b>	<b>30644</b>	<b>30639</b>
Connector to forceps	EU	US	EU	US	EU	US	EU	US	EU	EU
Compatibility brand/model	GIMA: MB 240, MB 380 VALLEY LAB, CONMED, CODMAN, OLYMPUS		GIMA: MB 120 F, MB 200 F, MB 200 D, MB 250, MB 300 D, MB 400 D LED: SURTRON 120, 200, 300, 400 VALLEY LAB, EMC, DOLLEY		GIMA: MB 122, MB 160, MB 200, MB 202		GIMA: MB 80 D, MB 120 D, MB 160 D LED: SURTRON 80, 120, 160		MARTIN, BERCHTOLD, AESCULAP, WOLF	ERBE, SELECT, DOWNS, SIEMENS

## SINGLE USE, METAL AND RUBBER PLATES

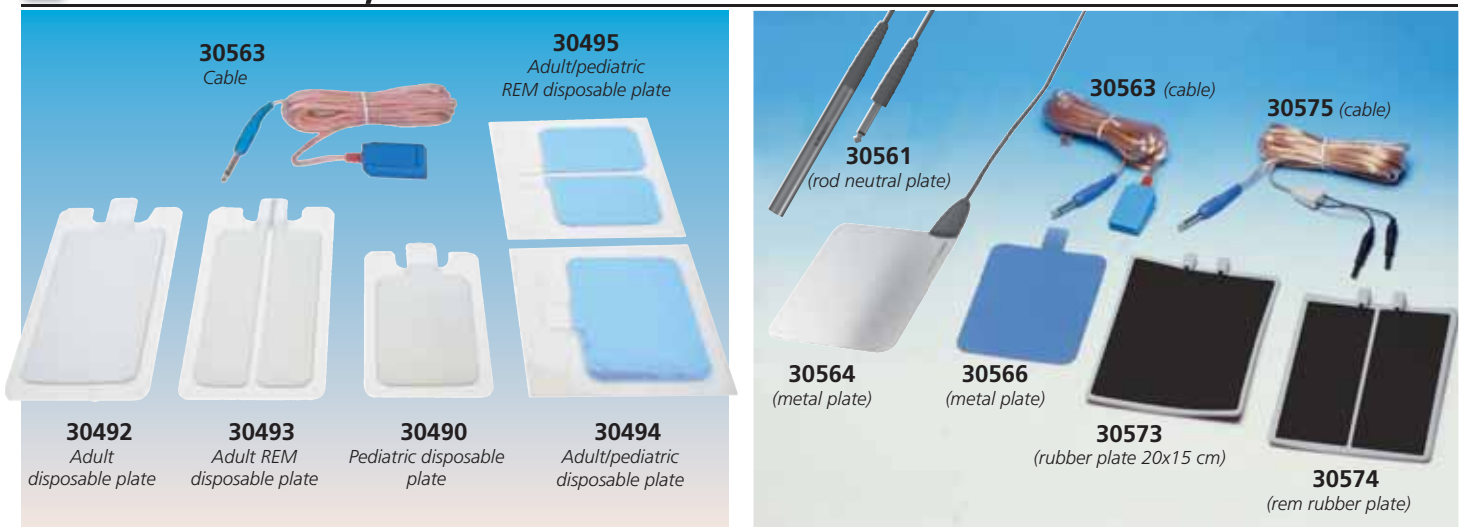

- 30492 DISPOSABLE GROUND PADS WITH SOLID GEL - adult
- 30493 REM DISPOSABLE GROUND PADS WITH SOLID GEL - adult
- 30490 DISPOSABLE GROUND PADS WITH SOLID GEL - pediatric
- 30494 DISPOSABLE NON WOVEN GROUND PADS - adult/ped
- 30495 REM DISPOSABLE NON WOVEN GROUND PADS - adult/ped

- 30563 CABLE FOR PLATES - 5 m
- 30564 SURGEON NEUTRAL PLATE 16x12 cm - with cable
- 30566 METAL PLATE - without cable
- 30573 RUBBER PLATE 20x15 cm - without cable
- 30574 REM RUBBER PLATE 20x15 cm - without cable
- 30575 CABLE FOR RUBBER PLATES

## 3M ELECTROSURGICAL GROUNDING PADS WITH SAFETY RING

- 30496 3M 9160 SPLIT GROUNDING PAD - box of 100
  - 30497 3M 9160F SPLIT GROUNDING PAD - box of 200 (40 pouches of 5 pieces)
  - 30498 3M 9165 SPLIT GROUNDING PAD - pre-recorded - box of 40
- The 3M 9160, and 9165 Universal Grounding Pads all have a conductor area of 15 square inches and come with the patented 3M Green Safety Ring technology which allows them to perform the same as grounding pads that are up to 33% larger in conductor area. Green Ring allows adult and pediatric use.

In addition, they have fluid resistant, non-woven backing which allows heat to pass through up to 25% faster than foam, and they have no minimum age or weight limit.



**30498**  
(3M 9165)



**30496, 30497**  
(3M 9160)

# UNIVERSAL HIGH QUALITY INSULATED BIPOLAR FORCEPS

## EUROPEAN CONNECTOR BIPOLAR FORCEPS

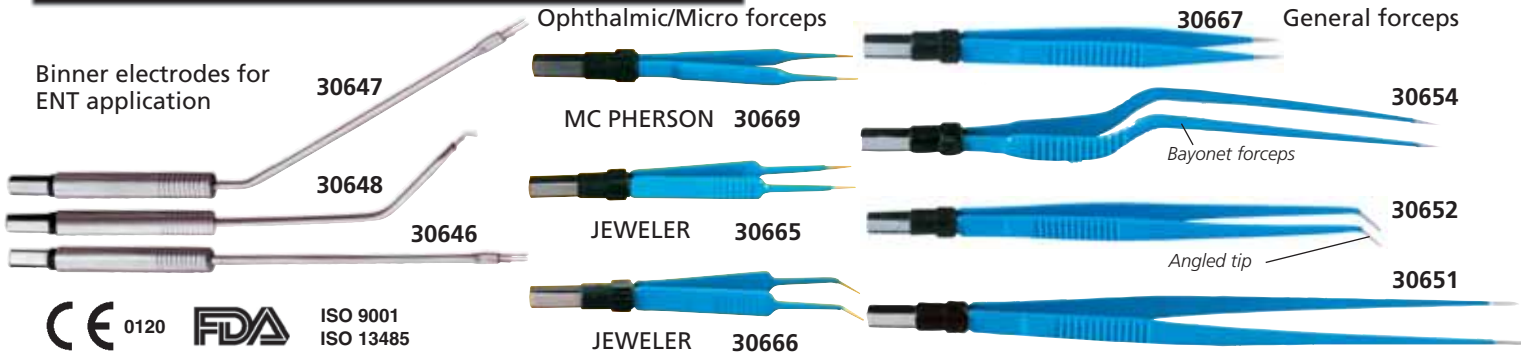

GIMA code	Model	Connector	Length		Tip style	Application	Tip size
			cm	inches			
30645	BINNER	EU	22 cm	8½"	ANGLED	ENT	-
30646	BINNER	EU	18 cm	7"	STRAIGHT	ENT	-
30647	BINNER	EU	18 cm	7"	ANGLED	ENT	-
30648	BINNER	EU	19 cm	7"	ANGLED 45°	ENT	-
30650	STRAIGHT	EU	18 cm	7"	STRAIGHT	GENERAL	1 mm round points
30656	STRAIGHT with irrigation	EU	18 cm	7"	STRAIGHT	GENERAL	1 mm round points
30651	STRAIGHT	EU	20 cm	7¾"	STRAIGHT	GENERAL	1 mm round points
30658	STRAIGHT	EU	20 cm	7¾"	STRAIGHT	GENERAL	2 mm round points
30652	STRAIGHT	EU	18 cm	7"	ANGLED	GENERAL	1 mm round points
30653	STRAIGHT	EU	20 cm	7¾"	ANGLED	GENERAL	1 mm round points
30657	BAYONET	EU	16.5 cm	6½"	STRAIGHT	GENERAL	1 mm round points
30654	BAYONET	EU	18 cm	7"	STRAIGHT	GENERAL	1 mm round points
30655	BAYONET	EU	20 cm	7¾"	STRAIGHT	GENERAL	1 mm round points
30659	BAYONET	EU	22 cm	8¾"	STRAIGHT	GENERAL	1 mm round points
30663	BAYONET	EU	24 cm	9½"	STRAIGHT	GENERAL	1 mm round points
30660	STRAIGHT	EU	18 cm	7"	ANGLED	GENERAL	0.3 mm points
30661	STRAIGHT	EU	18 cm	7"	STRAIGHT	GENERAL	0.3 mm points
30662	STRAIGHT	EU	20 cm	7¾"	STRAIGHT	GENERAL	0.3 mm points
30664	ADSON	EU	12.1 cm	6"	STRAIGHT	GENERAL	1 mm round points
30665	JEWELER 5	EU	11.5 cm	4½"	STRAIGHT	OPHTHALMIC/MICRO	0.25 mm points
30666	JEWELER 5	EU	11.5 cm	4½"	ANGLED	OPHTHALMIC/MICRO	0.25 mm points
30667	STRAIGHT	EU	15 cm	6"	STRAIGHT	OPHTHALMIC/MICRO	0.5 mm points
30668	STRAIGHT	EU	15 cm	6"	ANGLED	OPHTHALMIC/MICRO	0.5 mm points
30669	Mc PHERSON	EU	10.2 cm	4"	STRAIGHT	OPHTHALMIC/MICRO	0.5 mm points

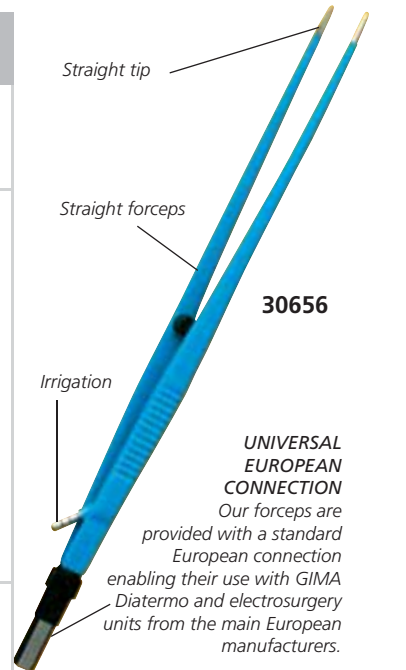

## US CONNECTOR BIPOLAR FORCEPS

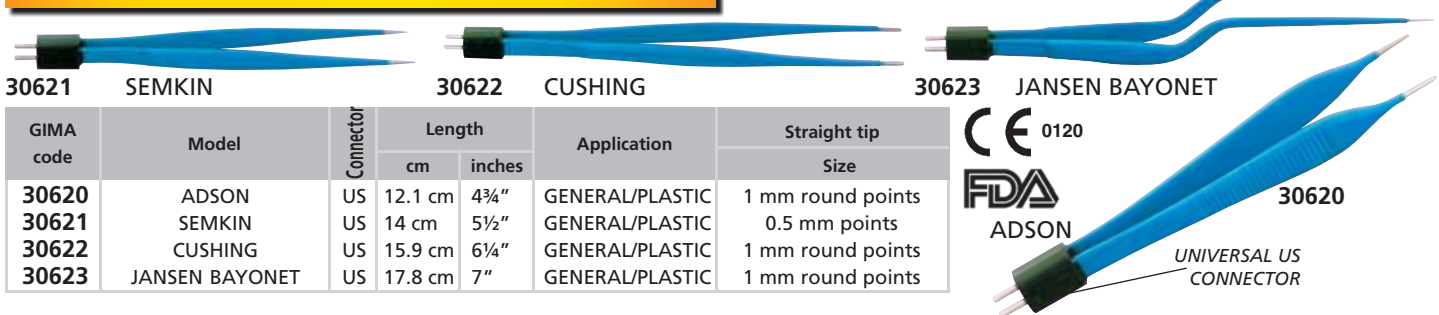

GIMA code	Model	Connector	Length		Application	Straight tip Size
			cm	inches		
30620	ADSON	US	12.1 cm	4¾"	GENERAL/PLASTIC	1 mm round points
30621	SEMKIN	US	14 cm	5½"	GENERAL/PLASTIC	0.5 mm points
30622	CUSHING	US	15.9 cm	6¼"	GENERAL/PLASTIC	1 mm round points
30623	JANSEN BAYONET	US	17.8 cm	7"	GENERAL/PLASTIC	1 mm round points

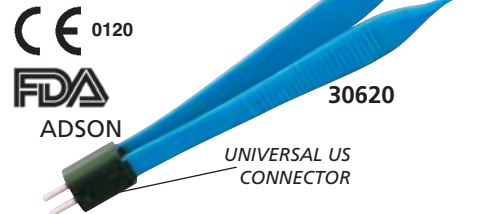

# EUROPEAN NON-STICK BIPOLAR FORCEPS

## NON-STICK BIPOLAR FORCEPS

Thanks to new Ag-Tech non-stick technology, the forceps stay clean, virtually eliminating the need for cleaning during

coagulation. A tip material with excellent thermal properties prevents the sticking of tissues. The non-stick effect is permanent and will not reduce with the use of forceps.

GIMA code	Model	Connector	Length		Tip style	Tip size
			cm	inches		
30460	STRAIGHT	EU	15	6"	STRAIGHT	1 mm
30461	STRAIGHT	EU	18	7"	STRAIGHT	1 mm
30462	STRAIGHT	EU	20	7¾"	STRAIGHT	1 mm
30464	STRAIGHT	EU	18	7"	ANGLED	1 mm
30465	STRAIGHT	EU	20	7¾"	ANGLED	1 mm
30468	BAYONET	EU	18	7"	STRAIGHT	1 mm
30469	BAYONET	EU	20	7¾"	STRAIGHT	1 mm
30472	JEWELER	EU	11.5	4.5"	STRAIGHT	0.7 mm
30473	JEWELER	EU	11.5	4.5"	ANGLED	0.7 mm
30474	ADSON	EU	12.1	4¾"	STRAIGHT	1 mm

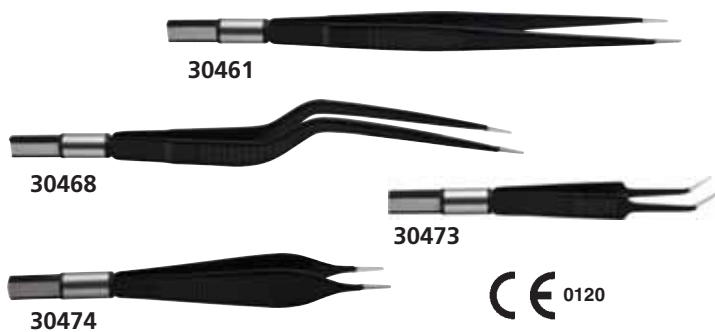

## FOOTSWITCHES AND BOARDS

GIMA code	FOOTSWITCHES FOR 50, 80, 106, MB 120, 122, 132, 160, 200, 202
30577	Waterproof MB footswitch - 2m cable
30578	Waterproof MB footswitch - 3m cable
ANTIEXPLOSION FOOTSWITCH FOR MB 120, 122, 132, 160, 200, 202	
30602	Double antiexplosion, water proof MB footswitch
ANTIEXPLOSION FOOTSWITCHES FOR MB 240, 250, 300D, 380, 400, 400D	
30603	Double antiexplosion, water proof footswitch - MB240-380
30604	Double antiexplosion, water proof footswitch - MB250-400-300D-400D
MAIN BOARD	
30557	Main board - specify model and serial number of diatermo with order
30558	Output board for MB 240, 250, 380, 400 - specify as above



It allows selection from pedal of CUT and COAG functions  
Antiexplosion and waterproof.

## MONOPOLAR FORCEPS, SCISSORS AND CABLES

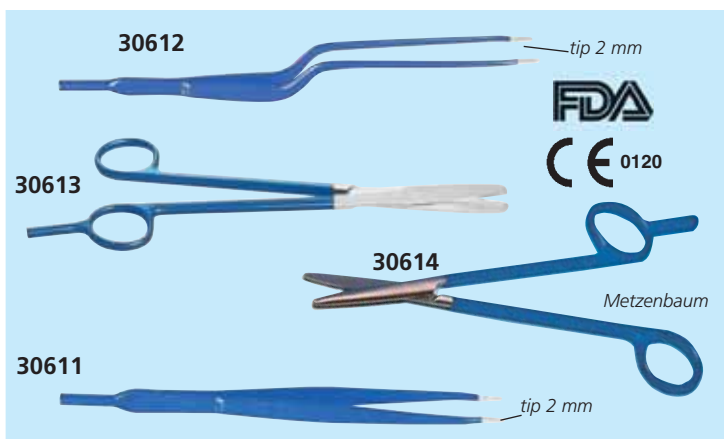

Monopolar forceps and scissors are provided with a 4 mm connection for standard monopolar cables. These can be used with all Gima, LED, Erbe and many other electrosurgical units in the market.

GIMA code	INSULATED MONOPOLAR INSTRUMENTS
30610	Monopolar cable - 4 mm pin
30611	Mc INDOE straight monopolar forceps 15 cm (6")
30612	Bayonet monopolar forceps - 20 cm (7 1/2")
30613	Monopolar scissors - straight - 18 cm (7")
30614	Metzenbaum monopolar scissors - straight - 18 cm (7")
30615	Metzenbaum monopolar scissors - curved - 18 cm (7")

## ELECTROSURGERY SMOKE EVACUATOR

### • 30450 SMOKE EVACUATOR

An aspiration and filtering system for the smokes produced during the surgical procedures.

The smokes, generated during the surgical procedures, have a bad, strong and persistent smell. These smokes consist of water vapour, organic gas, visible or invisible solid particles and viral parts. So a good aspiration and filtration eliminates bad smells, reduce the bacteriological and/or viral risks, and improves vision of the zone of the operation area during the laparoscopic procedures.

Activation of the aspiration can be:

- **Automatic**, through the remote electronic system of automatic survey of the activation of the high frequency electrosurgical unit

- **Manual**

- **Through a foot switch (optional)**

The aspiration flow can be adjusted to suit the specific needs.

For laparoscopic procedures there is a specific function L,

quickly selectable. Smoke evacuator has an electronic control of the aspiration with the indication of the wearing status of the filters. There are two different kinds of quickly replaceable ULPA type filters, with active carbons: the BLUE filter is the first filter and it is included with the unit for an initial time of use (5 hours), the RED filter is an optional spare part, developed for a long time use (20 hours). They have connector of 7/8".

- 30452 ULPA FILTER (20 hours) RED - spare
- 30453 ASPIRATION KIT - box of 6
- 30454 HANDLE ASPIRATION KIT - sterile - box of 12
- 30577 WATERPROOF MB FOOTSWITCH - 2 m



### TECHNICAL SPECIFICATIONS

Mains voltage	230 V (115 V on request)
Mains frequency	50/60 Hz
Electrical input power	800 VA
Max vacuum flow rate	1000 LPM (35 CFM)
Max static suction	250 mbar (83 in H <sub>2</sub> O)
Filter type	ULPA with active carbons
Filter efficiency	99,999%
Particles diameter	0.12 micron
Size	370x144x319 mm
Weight	4 kg

### STANDARD ACCESSORIES

- ULPA filter (5 hours) blue
- Aspiration kit ( filter + pipe Ø 22 mm, length 2.4 m)
- 4 handle aspiration kit ( adapter 10 mm / 22 mm , pipe Ø 10 mm, length 1.8 m, clip to fix the pipe to the handle, adapter to the handle)
- Power cable

## CHANGE-A-TIP™ CAUTERIES WITH HIGH TEMPERATURES

### BOVIE CAUTERIES

- interchangeable sterile tips
- replaceable batteries
- reusable handles
- no sterilization necessary



**30590**  
(Fine tip, not sterile, included)

GIMA code	INTERCHANGEABLE TIP CAUTERIES MINIMUM ORDER: 10 TIPS	Recommended for:
30590	Cautery handle "AA" (tip included)	All tips
30593	High temp loop tip - sterile	DER/ENT
30594	High temp 2" flex loop tip - sterile	GYN/ENT
30595	High temp 5" loop tip - long size - sterile	GYNAECOLOGY
30596	High temp fine tip - sterile	DER/CARDIO
30597	High temp elongated tip - sterile	VASECTOMY

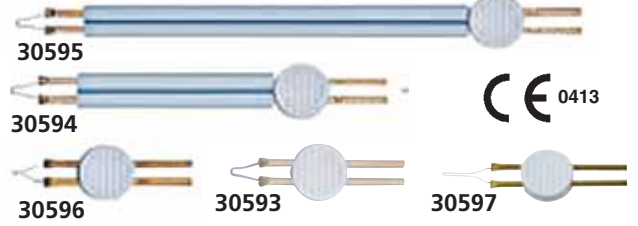

## REUSABLE HIGH TEMPERATURE CAUTERY WITH REPLACEABLE TIP

- CAUTERIES - 1,200°C (2,200°F) - made in Italy**
- interchangeable tips with nickel-chrome wire
  - replaceable batteries
  - reusable handles

Wide application in gynaecology, orthopedy, ear/nose/throat, dermatology, plastic and reconstruction surgery.

GIMA code	INTERCHANGEABLE TIP CAUTERIES MINIMUM ORDER: 10 TIPS
30598	Cautery handle "AA" (tip not included)
30599	High temp long fine tip - sterile - box of 10
30600	High temp large tip - sterile - box of 10
30601	High temp fine tip - sterile - box of 10

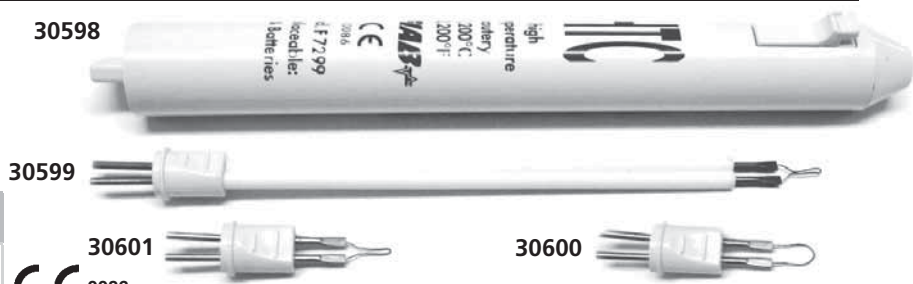

## HIGH TEMPERATURE ELECTROCAUTERIES

- **30580 ELECTROCAUTERY - 1,200 °C - fine tip - made in Italy**  
Electrocautery is a sterile bipolar battery operated disposable device for the cauterization of small vessels; the temperature of the tip is 1,200°C. With a **fine tip** required in most of the surgeries.
- **30582 GYNAECOLOGY CAUTERY - 1,200°C - fine tip**  
Same as 30580 but with the tip fixed on a 12 cm long shaft.
- **30581 ELECTROCAUTERY - 600 °C - fine tip**  
Same as 30580 but with lower temperature = 600°C. Especially designed for ophthalmology.
- **30583 EMERGENCY ELECTROCAUTERY - 800°C - Thick tip**  
Same as 30580 but with "thick tip" for the perforation of nails in case of haematoma.

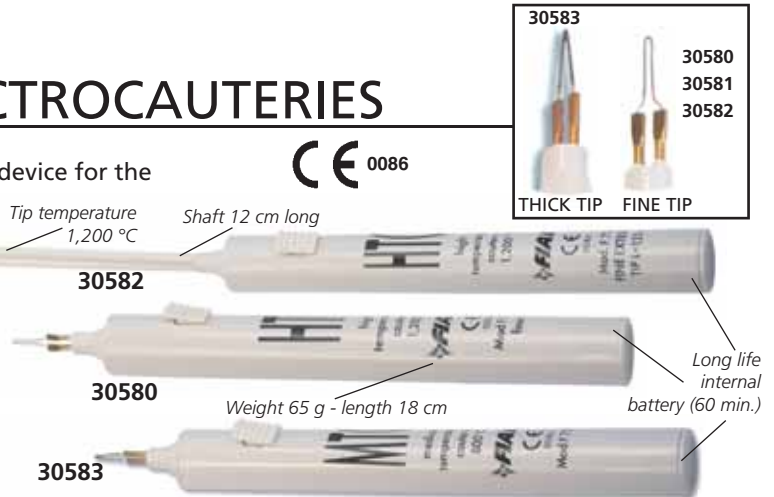

## CARTS FOR ELECTROSURGICAL UNITS

Trolley designed to hold and carry electrosurgical units (including Argon units). Ergonomics has been particularly considered for the design, for example the height of 900mm with inclined top shelf allows easy reading of the unit's display. The trolley is provided with a second shelf with antiskid raised edges, two drawers placed at the base and a rear space with securing straps to hold two Argon cylinders. The upright stands holding the shelves are designed to take possible optional accessories. All parts of the trolley are made of epoxy-painted, tempered steel and aluminum. Available version with 4 socket group, fuses box, independent grounding plug, power cable 3m.

TECHNICAL SPECIFICATIONS		
Load capacity:	- Total load 200 kg	- Inclined shelf 50 kg
Inclined shelf:	42x45 cm (27864/6)	50x50 cm (27865/7)
Drawers and shelf:	42x31 cm (27864/6)	50x36 cm (27865/7)

GIMA code	CARTS FOR ELECTROSURGICAL UNITS
27864	DIATERMO CART - medium
27865	DIATERMO CART - large
27866	DIATERMO CART with power - medium
27867	DIATERMO CART with power - large



## HISTOFREEZER® CRYOSURGICAL SYSTEM

- **30591 HISTOFREEZER® - kit with applicator 2 mm**  
Two 80 ml aerosol bottles and 60 applicators 2 mm.
- **30592 HISTOFREEZER® - kit with applicator 5 mm**  
Two 80 ml aerosol bottles and 52 applicators 5 mm.
- **30589 HISTOFREEZER® - large kit mixed applicators**  
Two 80 ml aerosol bottles, 24 applicators 2 mm, 36 applicators 5 mm.
- **30585 HISTOFREEZER® - mini kit mixed applicators**  
One 80 ml aerosol bottle, 16 applicators 2 mm, 16 applicators 5 mm.

The Histofreezer® portable cryosurgical system is a low cost, highly effective cryosurgical agent that provides safe and effective treatment for warts and other common benign skin lesions.

This therapeutic treatment makes use of local freezing for the controlled destruction or removal of living tissue.

Suitable for adults and children

### Effective use on 9 benign lesion types

	% of resolution*
- Verruca Vulgaris (Common Warts)	94%
- Verruca Plantaris (Plantar Warts)	86%
- Molluscum Contagiosum	100%
- Lentigo (Age Spots)	100% - facial 99% - non facial
- Condyloma(Genital Warts)	89%
- Seborrheic Keratosis	95%
- Acrochordon (Skin Tags)	100%
- Verruca Plana (Flat Warts)	93%
- Actinic keratosis (Facial and Non-Facial)	91% - facial 87% - non facial

\*Summary of resolution rates by type of lesion from a number of clinical trials obtained with histofreezer + post-treatment of 27% salicylic acid / 17% lactic acid  
Supplied with box and manual in: GB, FR, IT, DE, ES, NL, PL.  
From web you can download: GR, PT, TH, Arab.

Saturated 2 mm applicators will stay cold for 90 seconds.



30591



30591

Saturated 5 mm applicators will stay cold for 120 seconds.



30585



30592



30589

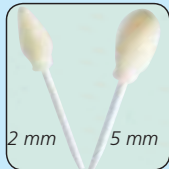

2 mm disposable applicator for small lesions  
5 mm disposable applicator for large lesions



**CHARGE**  
custom applicator  
press valve until droplets start to form.



**INVERT**  
canister for 15 seconds for optimal freezing temperature.



**APPLY**  
a frozen applicator to lesion for 15-40 seconds.

## BIOLOGICAL MICROSCOPES - MAGNIFICATION 40X-1600X

- **31002 LED BIOLOGICAL MICROSCOPE - 40X to 1600X**  
High level microscope with high resolution and transmission  
Main features:  
- infinite optical system  
- wide field eyepiece WF 10X/20  
- infinite semi-plan achromatic objectives 4X, 10X, 40X, 100X  
- Abbe condenser  
- backward quadruple nosepiece  
- double layers mechanical stage (size: 150x139 mm, move range 75x52 mm)  
- adjustable brightness  
- power supply: switchable 110-220 V, 50 Hz

- **31000 BIOLOGICAL MICROSCOPE - 40X to 1000X**  
- 30° compensation free binocular head  
- eyepiece 10X (Field 18 mm)  
- achromatic objectives 4X, 10X, 40X(S), 100X (S, oil)  
- semi plan achromatic objective 40X, 100X, 400X, 1000X,  
- interpupillary distance adjustment: from 55 to 75 mm  
- mechanical stage, double layers (size: 125x135 mm, move range: 75x35 mm)  
- Abbe condenser with iris diaphragm and filter  
- halogen lamp 6 V, 20 W - brightness adjustment  
- power supply: switchable 110-220 V, 50 Hz  
• **31005 SPARE BULB for 31000**



Large operating space with backwards nosepiece.

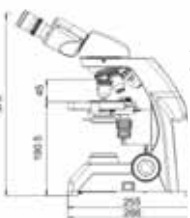

Sharp Image with high quality objectives.

31002

Focusing system: coaxial coarse and fine adjustment, fine division 0.002 mm, moving range 25 mm



**UNIVERSAL CAMERA FOR MICROSCOPES**  
see code 32185 page 194

Fine focusing knob



Binocular system

Quadruple nosepiece and objectives

Fine focusing knob minimum division 0.002 mm



31000

## GERMAN FLEXIBLE NOSEPHARYNGOSCOPE

### • 71602 FLEXIBLE NOSEPHARYNGOSCOPE with cable

The high precision multi-lens optics creates an optimal image. The thin insertion tubes are exceptionally maneuverable and have a special wide angle lens whereby a precise tip control and a remarkable depth of focus are reached. Exacting workmanship and high quality materials create absolutely homogeneous illumination. The handpiece is ergonomically formed and the insertion tube is especially comfortable for the patient. This naso-pharyngoscope, with its proven design, is guaranteed to bring years of trouble-free service.

- wide angle, multi-lens objectives for excellent image quality
- excellent ergonomics allows one hand operation
- suitable for mechanical cleaning and disinfection

71602



30830  
adaptor to Gima  
light source

30801

#### TECHNICAL SPECIFICATIONS 71602

Resolution: 7,000 pixels	Working length: 300 mm
Working Ø: 3.2 mm	Tip deflection: up 140°, down 140°
Length of tip deflection: 20 mm	Depth of focus: 6 -1,000 mm
Direction of view: 0°	Field of view: 70°
Weight: 260 g	Made in Germany

71602



Lever

ETO valve

3.2 mm diameter

Tip deflection



Supplied in lightweight aluminium rigid case with fibre optic cable, leakage tester and user manual (GB, IT)

### • 71610 ENDOSCOPY MOUTHPIECE - bag of 20 pcs Disposable bite blocks

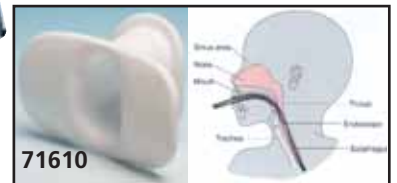

71610

## OTOSCOPIES

ACMI / WOLF / STORZ / OLYMPUS fitting

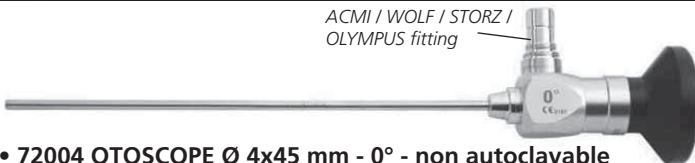

- 72004 OTOSCOPE Ø 4x45 mm - 0° - non autoclavable
- 72007 OTOSCOPE Ø 2.7x107.5 mm - 0° - non autoclavable
- 72008 OTOSCOPE Ø 2.7x107.5 mm - 30° - non autoclavable

## LARYNGOSCOPE

ACMI / WOLF / STORZ / OLYMPUS fitting



- 72021 LARYNGOSCOPE Ø 8x170 mm - 70° - non autoclavable

## SINUSCOPIES

ACMI / WOLF / STORZ / OLYMPUS fitting



- 72010 SINUSCOPE Ø 4x175 mm - 0° - non autoclavable
- 72011 SINUSCOPE Ø 4x175 mm - 30° - non autoclavable
- 72012 SINUSCOPE Ø 4x175 mm - 70° - non autoclavable
- 72013 SINUSCOPE Ø 4x175 mm - 45° - non autoclavable

## LIGHT SOURCE HANDLE

Connection to any endoscope with Storz fitting



- 30795 FLYER HALOGEN HANDLE 2.5 V - light source for endoscopes
  - 31478 BULB for 30795
  - 30794 FLYER LED HANDLE 2.5 V - light source
- Powerful handheld light source for endoscopes. 60,000 lux. Both flyer handles need 2xAAA batteries.

## Wi-Fi/USB CAMERA FOR ENDOSCOPES AND MICROSCOPES

- 32185 MICFIEYE - Wi-Fi/USB CAMERA (C-mount)
- 32186 C-MOUNT F18 ADAPTER FOR ENDOSCOPES
- 32187 MICROSCOPE ADAPTER Ø 23 mm

MICFIEYE is a Wi-Fi camera with C-mount and allows to digitalize the image on tablets, smartphones and PC using dedicated Apps and Softwares. MICFIEYE needs an adapter



32185+32187

32185+32186

Each camera is supplied with USB cable (1.2 m), USB AC adapter, user manual (GB, IT, FR, ES, DE), software can be downloaded free of charge from web

to be compatible with all optical devices such as microscopes, endoscopes, boroscopes, fiberscopes, C-mount lenses etc.

#### TECHNICAL SPECIFICATIONS

Camera Type:	Colour CMOS camera
Sensor:	¼ Imax CMOS
Resolution:	1.3 MP
Image pixel:	320x240, 640x480, 1280x1024
Lens standard:	C-CS mount CCTV lens
Automatic optical features:	Gamma correction, exposure, white balance, black reference, flicker avoidance, defect identification, colour saturation
Button snapshot:	yes for Wi-Fi and USB mode
Dimension:	Ø 36x75 mm
Wi-Fi transmission distance:	≥5 m
Video resolution:	1.3 MP, 320x240, 640x480, 1280x1024
Frequency range:	2,400-24,835 GHz
Li-Ion battery:	Continuous working time - approx 2.5 hours
Power source:	5 V / 1A or USB (use only USB wall adaptors certified according the CE and/or FCC regulations)
OS support:	iOS / Android / Windows / Mac
Software features:	USB and Wi-Fi MIC-fi: snapshot, video recording, calibration and measurement. Take time lapsed picture, (only USB Micfeye)

## 150 W HALOGEN LIGHT SOURCE

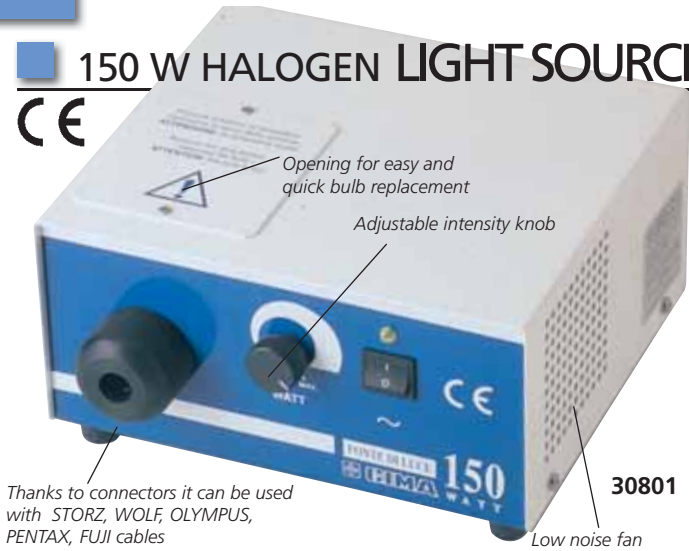

### • 30801 GIMA HALOGEN LIGHT SOURCE 150 Watt

Compact, lightweight, powerful light source for endoscopic use. A low noise fan positioned behind the halogen bulb provides the necessary cooling inside the metallic structure of the light source. A variable-intensity regulator enables selection 50 to 150 W. User manual in GB, ES, FR, IT, GR, PT.

GIMA code	CONNECTORS FOR GIMA LIGHT SOURCE TO DIFFERENT CABLES	TECHNICAL SPECIFICATIONS
30810	STORZ cable connector	Input for GIMA, SCHOLLY and LUT cables Dimension: 21x20x h 11 cm Max power absorption: 170 Watt Two protection fuses: 1.6 A.T. Power supply: 230V-50 Hz Norms: IEC 601-1 - 93/42/EEC (Class: I - Type: BF) Made in Italy: GIMA S.p.a.
30811	WOLF cable connector	
30812	OLYMPUS cable connector	
30815	PENTAX cable connector	
30816	FUJINON cable connector	
30808	Spare lamp 150W	

## LED LIGHT SOURCE

### • 27544 LED LIGHT SOURCE

Cold white light (5,500 °K, 200 lumen) for endoscopy use. It can be connected to endoscopes without need of F.O. cable. Handle connect directly to rigid endoscopes (Storz connection).

LCD display: 12.8x6.4 cm



## F. O. HEAD LIGHTS



- 30850 WIDA FIBRE OPTIC HEAD LIGHT
- 30854 WIDA PLUS FIBRE OPTIC HEAD LIGHT fibre optic cable complete with head light system

WIDA illumination systems are available in two versions: one with simple headband and standard illumination head, the other with professional headband, easily adjustable, and thin head. Both include F.O. cable with adaptor (30830) for connection to GIMA light source (30801).

Here below are available connectors to other light sources. Light beam can be focused through a focusing ring.

### • 30852 FOCUS DEVICE for 30850 (since lot 14 - may 2012)

It reduces light in a very luminous spot Ø 10 mm.

#### Diameter focus:

DISTANCE	30850	30854
20 cm	7-15 cm	6-10 cm
30 cm	10-22 cm	9-15 cm
50 cm	16-35 cm	14-20 cm

An exceptionally bright headlight with an illumination head for coaxial, shadow-free illumination of the viewing area.



## SURGICAL FIBRE OPTIC LIGHT CABLES AND ADAPTORS

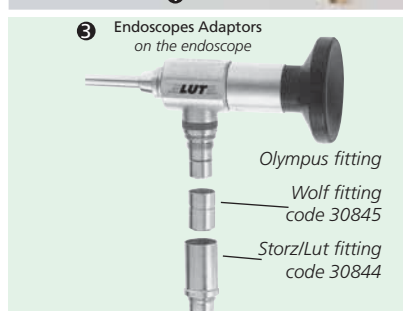

### 1 LIGHT SOURCE ADAPTORS to connect GIMA F.O. cables to light sources

- 30830 GIMA light source adaptor
- 30831 STORZ - AESCULAP - MARTIN light source adaptor
- 30832 WOLF - HENKE SASS - DYONICS - MEDICON - COMEG light source adaptor
- 30833 OLYMPUS light source ad.
- 30834 ACMI light source adaptor
- 30835 HEINE light source adaptor
- 30836 FUJINON light source adaptor
- 30837 PENTAX light source adaptor

### 2 ENDOSCOPE ADAPTORS - on the cables to connect endoscopes to GIMA F.O. cables

- 30840 ENDO STORZ adaptor
- 30841 ENDO WOLF adaptor
- 30842 ENDO ACM, OLYMPUS-STRYKER adaptor

- 30817 FIBRE OPTIC CABLE 3.5 x 1,800 mm
- 30818 FIBRE OPTIC CABLE 4.8 x 1,800 mm
- 30822 FIBRE OPTIC CABLE 3.5 x 2,300 mm
- 30823 FIBRE OPTIC CABLE 4.8 x 2,300 mm
- 30826 FIBRE OPTIC CABLE 4.8 x 3,000 mm

High transmission surgical light cables, armoured but highly flexible with unique features:

- no burn outs
- strain relieved and protected by **silicone hose**
- **steam autoclavable** with warranty (12 months)
- light source end temperature resistant up to 300°C
- kink resistant
- no electrical interferences with endoscopic surgery units
- surgical stainless steel end fittings resist wear and corrosion
- stainless steel adaptors enables our cables to be used with other manufacturers halogen light sources/instruments

### • 29975 FIBRE OPTIC CLAMP

- 29975 FIBRE OPTIC CLAMP
- 30840 ENDOSCOPE ADAPTORS - on the endoscope to connect endoscopes to GIMA F.O. cables
- 30844 STORZ/LUT ENDOSCOPE ADAPTORS
- 30845 WOLF ENDOSCOPE ADAPTORS

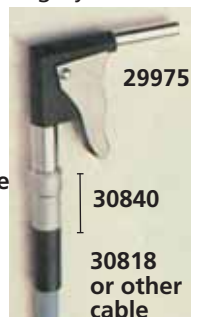

# GIMA ENT HEAD MIRRORS FOR BATTERY OR AC/DC TRANSFORMER USE

Simple adjustment of the band using rotating knob to fit any head size



31110

Comfortable, padded head band easy to remove for cleaning

## HEAD MIRRORS WITH TRANSFORMER

Supplied with plug-in transformer for direct power



31111

Head mirror Lux-100 with plug in transformer

Storz type head mirror  
Silver coated mirror produces extremely bright light

Simple adjustment of the band using rotating knob



31108

Comfortable, padded head band easy to remove for cleaning



31109

On/off switch on battery

Supplied with head band mounted CR-123A battery box for 2x3 V batteries (not included)

Silver coated mirror produces extremely bright light

## HEAD MIRRORS WITH BATTERY

Extension cable

Clear type head mirror

## LUX-100 AVAILABLE WITH LED LIGHT

Quality head mirrors Ø 55 or 100 mm to perfectly illuminate the examination area in every situation. Long life 6 V lamp provides bright and natural light, quality silver coated mirror allows optimum light reflection. Mirror and light beam can be easily and precisely adjusted.

STANDARD ACCESSORIES	LUX AC/DC TRANSFORMER 31110-31111	LUX BATTERY* 31107-31109 31112
Mirror with head band	•	•
Long life bulb	•	•
Head band mounted battery case** for 2 x 3V CR-123A	•	•
Plug in transformer* 100/240 V - 50/60 Hz with cable	•	•
Pocket battery case	•	•
Sturdy plastic case	•	•
Cordura bag	•	•
Extension cable 80 cm and on/off switch 30 cm cable	•	•

\*Supplied with interchangeable UK, US, EU plugs

\*\*Battery not included

GIMA code	LUX ENT MIRRORS
31108	LUX-55 battery** head mirror - Ø 55 mm - 6 V
31112	LUX-55 battery*** head mirror - Ø 55 mm - 6 V
31109	LUX-100 battery** head mirror - Ø 100 mm - 6 V
31107	LUX-100 battery** LED head mirror - Ø 100 mm - 6 V
31110	LUX-55 AC/DC transformer head mirror - Ø 55 mm - 6 V
31111	LUX-100 AC/DC transformer head mirror - Ø 100 mm - 6 V
31114	Mirror for LUX-55 - spare
31115	Mirror for LUX-100 - spare
31116	Bulb for LUX mirrors - spare
31119	Carrying bag for LUX mirrors - black
31117	Battery case for LUX mirror 31112/3 - spare
31124	Connecting cable 30 cm for 31107-9 - spare
31118	Plug in transformer* 100-220 V - 50/60 Hz with cable - spare for 31100-1 - optional for 31107-9

\*Supplied with interchangeable UK, US, EU plugs \*\*Battery mounted on head mirror band \*\*\*Pocket battery case connected to head mirror

# HEAD LOUPE AND MAGNIFYING GLASSES



31170

Visual field 8.5x3 cm

## • 31170 HEAD LOUPE two magnifying systems (2.2X and 3.3X)

The system is mounted on an adjustable webbing head band and provided with two separate lenses. The first lens provides a 2.2X magnification, moving down the second lens, we reach a total 3.3X magnification. The superior quality of this lens permits high precision examinations. It can be used in combination with

any kind of glasses. Working distance: 17 cm with 2.2X lens, 9 cm with 3.3 lens. Made in Japan.

## • 30861 DANAE MAGNIFYING GLASSES

Light, only 83 g



Adjustable 0-4.5 cm

Compatible with TETI protective shield (see page 16, 198)

- optical system with 3 magnifying glasses (2X, 2.5X, 3X)
- can fit over your glasses
- adjustable to any face shape

## • 30848 SMART MAGNIFYING GLASSES

Spectacle frame with magnifying glasses useful to physician whenever it is necessary to have a magnified view of the visual field and be able to use both hands. Lightweight, it folds up, and can be worn over spectacles. 2.5X zoom lens which can be tilted to achieve optimum focus.



30848

# ZIEGLER MIRROR



## • 31142 ZIEGLER MIRROR - Ø 90 mm

Concave back-silvered mirror, 90 mm diameter with 13 mm diameter hole, on adjustable band. Special mount permits replacement of glass mirror in event of breakage. Made in Germany.

# 1 W LED HEADLIGHTS

## • 30858 LED HEADLIGHT

Run time: High mode: 3 hours - Low mode: 22 hours  
Luminous intensity: 120 lumens (high) or 30 lumens (low)  
30 feet drop test, super bright CREE cool white LED  
MCU control push switch (High/Low/Off) 60° pivoting head.  
Passed extreme temperature shock test, IPX4 water resistant  
10,000 switch cycle life  
Lighting leakage design when forget to turn off switch. 3AAA batteries included.

## • 32200 "AAA" ALKALINE BATTERIES - blister of 4 pcs - spare



Compact and lightweight headlight only 65 g

## GIMA LED HEADLIGHT



30940

### TECHNICAL SPECIFICATIONS

Illumination light spot at 420 mm: 20-80 mm  
 Illumination at 200 mm working distance: ≥ 85,000 lux  
 Adjustable range  
 Fluctuation distance: 12.5 mm  
 Angle range: vertical ± 25° adjustable  
 Weight of headlight (excluding head band): 69 g  
 Illumination source: extremely bright light, 5 W LED, life 20,000 hours  
 Battery: 7.2 V/4,600mAH lithium battery  
 Battery run-time: not less than 7 hours continuous run-time on a fully charged battery (charging time: 5 h)  
 Voltage: 100-240 VAC, 50-60 Hz  
 Maximum input power: 15 W  
 Power adapter output: DC 12 ±0.5 V, 1.5 A  
 Electrical safety standard: IEC60601.1, class II type BF equipment

- 30940 GIMA LED LIGHT - 5W - black
- 30941 BATTERY PACK for 30940 and 30890\* (need adaptor) - spare  
\*Old Gima Led light - light blue
- 30942 ADAPTOR BATTERY PACK\*\*

\*\*Only for use of battery pack (30941) with old Gima head light (30890)

Led lamp without the heat of traditional halogen headlight. With a colour temperature of 5,500 °Kelvin, it provides bright, white, shadow-free light allowing the doctor to see tissue characteristics without distortion. Flexibility of operation using the rechargeable lithium battery, instead of direct power source. Comfortable lightweight headlamps suitable for all kinds of surgery, ENT or dental applications. The headlight can be used when it is charging, it also has low-battery indicator light. Adapts to GIMA binocular loupes (codes 30892-8, 30910-5). Smart design, convenient for mobile diagnosis. Supplied in aluminium box with rechargeable 7.2 V / 4,600 mAH lithium battery and recharger. Manual: GB, FR, IT, ES, DE, PT, GR, Arabic.



## GIMA BINOCULAR LOUPES

### BINOCULAR LOUPES:

Light weight, ergonomically superior Galilean-style flip-up loupes. Can be used independently or mounted on 30890, 30940. Multi-coated and high grade glass lenses provide clean and sharp image. Eyepiece with wide field of view. Deep focus to see object stereoscopically. Loupes angles can be easily adjusted between 0° and 40° to minimize fatigue even after prolonged use. 6 mm up and down displacement. Adjustable pupil distance to fit different face types.



### STYLE BINOCULAR LOUPES:

Line of binocular loupes with same features of traditional line but mounted on a extra light, fashionable frame.



GIMA code	BINOCULAR LOUPES	Magnification	Working distance	Field of view Ø
30892	Binocular Loupe	2.5X	340 mm	80 mm
30894	Binocular Loupe	2.5X	420 mm	100 mm
30897	Binocular Loupe	3.5X	340 mm	60 mm
30898	Binocular Loupe	3.5X	420 mm	72 mm

GIMA code	STYLE BINOCULAR LOUPES	Magnification	Working distance	Field of view Ø
30910	Style binocular Loupe	2.5X	340 mm	80 mm
30911	Style binocular Loupe	2.5X	420 mm	100 mm
30914	Style binocular Loupe	3.5X	340 mm	60 mm
30915	Style binocular Loupe	3.5X	420 mm	72 mm

## RIESTER RI-FOCUS LED HEADLIGHT

### • 30881 RI-FOCUS LED HEADLIGHT - with rechargeable batteries

High performance LED headlight with battery compartment for fast and easy change of battery. Flexible hinge for a comfortable one-hand use of the LED illumination body.

- more efficient diagnosis due to white and high performance LED with up to 100,000 LUX and 50,000 hours lifetime
- wireless headband with built-in battery compartment
- particularly comfortable with balanced headband and one-hand operation
- focusable LED lamp at a distance of 40 cm approx Ø 40 mm to 200 mm infinitely focusable
- white LED with 6,000 °Kelvin, 140 lumen
- significantly less heating and energy loss
- rechargeable battery operation: approx 90 min with fully charged batteries

Rechargeable AAA batteries and plug in 230V charger included



### TECHNICAL SPECIFICATIONS

Distance:	400 mm	200 mm
Lux max:	10,000	23,000
Circle of light max Ø:	200 mm	120 mm
Circle of light min Ø:	40 mm	30 mm

## HEINE LED HEAD LIGHT

**POWERFUL LED ILLUMINATION**

**50,000 LUX at 250 mm**

**5 YEARS WARRANTY**



30884

- **30884 HEINE ML4 LED<sup>HQ</sup> HEAD LIGHT - J.008.31.413**
- LED in HQ; defining optimal light intensity (50,000 lux at 250 mm), brightness and homogeneity from edge to edge, and colour rendering (4,500 k, CRI >90, R9 > 75). This ensures true colour tissue for the most accurate diagnosis.
- **Coaxial illumination:** ensures a completely shadow-free image and allows for excellent illumination of difficult to see areas.
- **Lithium Battery:** for up to 8.5 hours of continuous working.
- **LED Thermal Management:** guarantees consistent quality and performance throughout the LED's lifetime (50,000 hours).
- **Adjustable illumination spot size:** 30 to 80 mm spot size range (at 420 mm working distance) to fit any examination situation.
- **Comfortable and secure fit:** multiple adjustment points and soft padding for comfort and stability even during long procedures.
- **Illumination Intensity Control:** for precise brightness setting. Rechargeable battery pack and direct mains transformer included.
- **30883 HEINE ML4 LED<sup>HQ</sup> HEAD LIGHT with DV1 DIGITAL VIDEOCAMERA and mPack<sup>®</sup> UNPLUGGED - J-008.31.470**
- Same as above with high resolution digital videocamera 1.3 megapixel
- **30886 HEINE BINOCULAR LOUPE 2.5X-340 mm - J.000.31.370**
- **30887 HEINE BINOCULAR LOUPE 2.5X-420 mm - J.000.31.371**
- **30888 P2 POLARIZATION FILTER FOR ML4 AND 2.5X LOUPES - J.000.31.326**

**TECHNICAL SPECIFICATIONS**

Power supply: mPack<sup>®</sup> Rechargeable Battery Pack with Li-ion battery and direct mains transformer

Illumination: 50,000 lux at a working distance of 250 mm

LED operating life: 50,000 hours

Spot adjustment: 30 mm to 80 mm illuminated field diameter (at 420 mm)

Colour temperature: 4,500°K Made in Germany

## HEINE BINOCULAR LOUPES



### HEINE<sup>®</sup> S-FRAME<sup>®</sup> WITH BINOCULAR LOUPES

- **Achromatic optics:** crisp, bright image with colour-correction.
- **Multi-coated, scratch-resistant silica glass lenses** - produce crisp, clear images. High magnification with a large field of view and excellent depth of field.
- **Water resistant**
- **Flexibility for precise adjustment:** independently adjustable Pupillary Distance controls ensure precise alignment of the optics, for a stereoscopy view.
- **i-View loupe mount;** provides any angle of view and the possibility flips up and down the optics to exclude or re-include the magnification during any procedure.
- **Different magnification and working distance.**

GIMA code	BINOCULAR LOUPES	Magnification	Working distance	HEINE code
30930	Heine binocular loupes	2.5X	340 mm	C-000.32.355
30931	Heine binocular loupes	2.5X	420 mm	C-000.32.356
30932	Heine binocular loupes	4X	340 mm	C-000.32.431

- **30888 P2 POLARIZATION FILTER FOR ML4 AND 2.5X LOUPES - J.000.31.326**
  - **30935 HEINE LED LOUPELIGHT with mPack<sup>®</sup> LL and plug-in transformer - C-008.32.264**
- HEINE LED in HQ (50,000 lux at 250 mm, 4,500 k, CRI>90, R9 > 75) provides the best coaxial, intense, accurate and homogeneous LED illumination. 17 hours continuous ON time at full power with mPack LL. LED Thermal Management ensures consistent quality and performance of the illumination throughout the LED's lifetime rating of up to 50,000 hours.



## IUKO VISION MODULAR SYSTEM

### GALILEAN TELESCOPES

- **30864 CALLIOPE - Galilean telescope 3X - dental (working distance 35 cm)**
- **30865 CALLIOPE - Galilean telescope 3X - surgical (working distance 45 cm)**
- **30866 CALLIOPE - Personalized Galilean telescope: magnification from 2X to 3X, working distance from 28 to 60 cm - specify with order**



### TELESCOPE + PROJECTOR

- **30870 NIKE - Galilean telescope 3X (35 cm) + projector**
- **30871 NIKE - Galilean telescope 3X (45 cm) + projector**
- **30876 BATTERY PACK - spare**



### ADJUSTABLE PROJECTOR

- **30867 IRIDE - LED light projector**
- **30876 BATTERY PACK - spare**

Irde is supplied with a compact, light, rechargeable power bank (battery), a 15 cm cable for use on head band and one 1 m cable for use from pocket



### SHIELD + TELESCOPE and/or PROJECTOR

- **30860 TETI - protective shield (2 shields included)**
- **30875 SET OF 5 TRANSPARENT FACE SHIELDS - spare**



# PENTALED 63N THEATRE LIGHTS

## PENTALED 63N

PentaLED 63N is a high-tech product designed to guarantee excellent performance levels. PENTALED 63N has 72 elliptical reflectors split into 8 modules, each containing 9 LEDs. The modules are mechanically focused by rotating the sterilizable handle. The multiplicity of the luminous sources and the elliptical geometry of the paraboloids studied to reflect in the depth the light beams generated by the LEDs, grant scalytic light for a three-dimensional illumination without shadows.

### Comfortable use

Thanks to the principle of indirect light, the lamp oriented towards different positions does not dazzle the surgeon and the assistants. The size of the lit field is adjusted mechanically through handle according to the light required by the surgeon.

### Superior lighting features

Membrane keyboard activates the following functions:

- selection of the colour temperature 5,000°K and 4,500°K
  - adjustment of the light intensity up to 160 Klx
  - on/off
  - endo light with colour selection (comfortable light for endoscopy intervention)
- The colour temperature of 5,000°K stimulates the surgeons' concentration, does not strain their sight, reproduces the colour of the tissues faithfully and increases the definition of the edges.

### Reliable and long lasting performances

The modular construction of the electronic board that feeds the LEDs guarantees continuous light, even in the unlikely event that a LED or board component should fail. The lighting body is protected by tempered glass screen, covered by a special film avoiding any fallen down splinters in case of break.

### Easy manoeuvrability

The reduced dimensions and the light reflector provide extreme manoeuvrability and stability. Smooth 360° rotation. The extremely light structure, the aluminium treated bar attached to the upper front of the cupola, the ultra-thin dome (only 13 cm) allow simple movements.

### Battery group, TVCC camera, monitor holding camera on request

Every lamp can be supplied with an emergency battery group with automatic charger (hours autonomy: 2.5 (49200), 2.5 (49201), 2 (49202)), TVCC camera or monitor holding arm.

### Full certification

Complies with European Directives 93/42/EEC and 2007/47/EC 'Class I - Medical Device' CE marking. Made in Italy.

63N 160,000 LUX



RIMSA

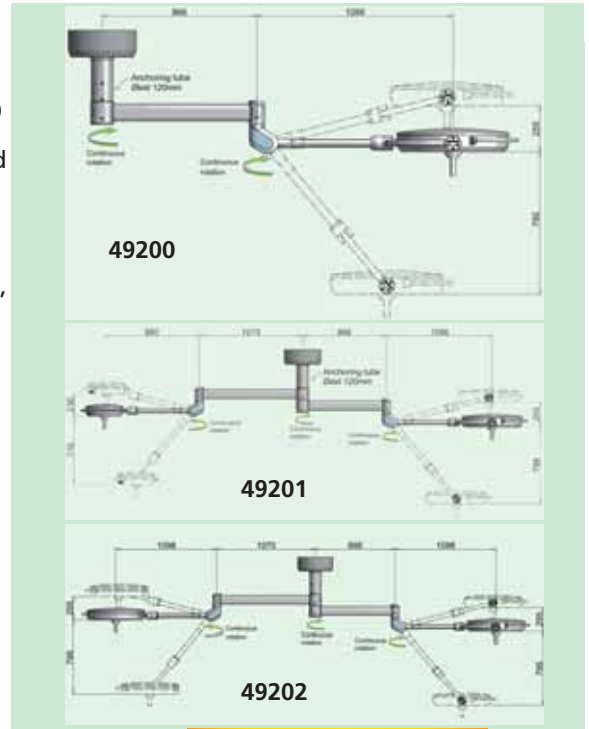

63N+30N 320,000 LUX (160,000+160,000 LUX)

GIMA code	PENTALED 63N THEATRE LIGHTS - CEILING*
49200	PENTALED 63N - 160,000 LUX
49201	PENTALED 63N+30N double - 320,000 LUX - compact
49202	PENTALED 63N+63N double - 320,000 LUX - plus
*Ceiling >3.80 m needs 49220	
ACCESSORIES	
30738	Autoclavable handle - spare
49205	Monitor holding arm - stand alone
49206	IR remote control - single lamps
49207	IR remote control - double lamp
ACCESSORIES TO BE ORDERED WITH LIGHT	
49210	Battery group with automatic charger for 63N
49211	Battery group with automatic charger for 63N+30N
49212	Battery group with automatic charger for 63N+63N
49213	STD TVCC camera for 63N - including lamp setup
49214	HD TVCC camera for 63N - including lamp setup
49215	Monitor holding arm - integrated with lamp
49220	Special structure for high ceiling (>3.8 m)



### TECHNICAL SPECIFICATIONS

		63N	30N
Performance	Light intensity at 1 m distance (Ec)	klx 160	160
	Colour temperature: double selection	°K 4,500/5,000	4,500/5,000
	Colour rendering index (CRI)	Ra 96	96
	Light field diameter adjustable from/to	cm 21-42	18-30
	Total radiated energy Ee where the illumination reaches max level	W/m <sup>2</sup> 543	543
	Number of LED	72	30
	Diameter and focus adjustment	manual	manual
	Depth of illumination IEC 60601-0-41 L1+L2 at 60%	cm 46	55
	Depth of illumination IEC 60601-0-41 L1+L2 at 20%	cm 108	115
	Control of illuminance	% 25-100	25-100
Electrical data	Endo LED light intensity min-max	klx 5-20	9-25
	Operating power (VAC)	V 100-240	100-240
	Operating power Vdc	V 24	24
	Electrical absorbed power	VA 145	70
	Frequency	Hz 50/60	50/60
General data	Average LED life	h 50,000	50,000
	Colour	RAL 9003	9003
	Minimum height of the room	cm 260	260
	Outer reflector diameter	cm 63	40
	Useful lighting surface	cm <sup>2</sup> 1710	712
	Weight	kg 45	35

## GIMALED O.T. LED LIGHTS - 160,000 LUX

GimaLed light with **81 Led**: sophisticated design which combines excellent lighting features with exceptional mechanical characteristics for extra soft movement.

**Deep light**: 27 inner fixed Leds for central illumination and 54 Leds (six modules of nine Leds each) moved by servo-motor, allow surgeon to adjust light field diameter.

**Shadowless light**: 81 Leds arranged on a round surface grant the best light emitting surface and avoid any shadow effect caused by any interposition between light beams and lighted surface.

**Bright light**: two colour selections, 4,000K and 4,600K, made of white Leds only, no coloured shadow effect. Light intensity of 160,000 Lux.

### Major features

- collimated light beams for a working distance from 70 to 160 cm
- high colour rendering index (CRI) 95, R9 >90
- optimisation of LED thermal management by heat dissipation convection to avoid illuminance reduction during surgery
- PMMA optical lenses and polycarbonate protective screen
- Zener to grant light in case of even one Led failure
- reduced consumption, high efficiency
- optional pre-wired system for Wi-Fi HD camera

GIMA code	GIMALED
49180	GimaLed-mobile
49181	GimaLed-mobile with battery group and automatic charger
49182	GimaLed - ceiling*
49183	GimaLed - ceiling* - double
49197	Autoclavable handle
49205	Monitor holding arm - stand alone
49220	Special structure for high ceiling (>3.8 m)
49185	GimaLed wall remote control
49186	Set up kit for HD Wi-Fi camera**
49187	HD Wi-Fi camera - need 49186

Battery group available on request for all models

\*Ceiling >3.80 m needs 49220

\*\*Installation must be done by Gima at the order

Small overall dimensions of cupola, perfectly balanced, ensure stable adjustment.

Ergonomic grip in the cupola and in the protective screen to hold and move the lamp

Motorised light field diameter adjustment through sensitive sterilisable handle or touch pad at the side of the cupola

49183

Thin and easy-to-adjust reflector

160,000 LUX

49180

### TECHNICAL SPECIFICATIONS

Light intensity at 1 m distance (Ec)	Klx 160
2 Colour temperature - switchable	*K 4,000 and 4,600
Colour rendering index (CRI)	Ra 95
Light field Ø (adjustable)	11-35 cm
Light field Ø where illuminance reaches 10% of Ec (d10)	260 mm
Light field Ø where illuminance reaches 50% of Ec	150 mm
Total radiated energy Ee where illumination reaches max level	556 W/m <sup>2</sup>
Average LED life	hours 50,000
Power supply:	100-240 V - 50-60 Hz - 61-71 W
Regulations:	IEC 60601-2-41 - 93/42/EEC
Made in Italy	

## PENTALED 30E SURGERY LAMP 160,000 LUX

### LED LIGHT INNOVATIVE TECHNOLOGY

A compact size hi-tech product that guarantees great performance levels. It has 30 elliptical reflectors split into 6 modules each containing 5 LEDs, providing 160,000 LUX - **selectable 4,500 °K - 5,000 °K**. By simply pressing the digital key, the surgeon can choose two different white light temperatures

- **E-view**. Innovative lens allows the surgeon to expand/narrow the illuminated operating field electronically, without altering intensity of light.

- **E-comfort**. The indirect LED's creates 3D shadowless illumination of the operating field, no risk of dazzling

- **E-white**. Only white LED's to avoid risk of perception of colour temperature variations or coloured shadows

- **E-deep**. Centre of light is fitted with extra LEDs module specifically designed to reflect deep light. This means that surgeon can work with perfect 3D lighting.

**Battery and high definition camera on request**. Optional battery group with automatic charger (4 hours autonomy) and high definition integrated camera (for ceiling and wall models only).

GIMA code	PENTALED 30E
30780	Pentaled-mobile
30779	Pentaled-mobile with battery group and automatic charger
30781	Pentaled - wall
30782	Pentaled - ceiling*
30783	Pentaled - ceiling* - double
30785	Autoclavable handle - up to serial number 12071
30738	Autoclavable handle - since serial number 12072
49205	Monitor holding arm - stand alone
49220	Special structure for high ceiling (>3.8 m)

\*Ceiling >3.80 m needs 49220

### TECHNICAL SPECIFICATIONS

Adjustable light intensity at 1 m distance (Ec)	Klx 160	Total radiated energy Ee where illumination reaches max level	W/m <sup>2</sup> 540
Colour temperature - switchable	*K 4,500 to 5,000	Average LED life	hours 50,000
Colour rendering index (CRI)	Ra 96	Power supply:	100-240 V - 50-60 Hz - 70 VA
Light field (electronically adjustable)	16-30 cm	Regulations:	IEC 60601-2-41 - 2007/47/EC
Light field Ø where illuminance reaches 10% of Ec (d10)	mm 160	Made in Italy	
Light field Ø where illuminance reaches 50% of Ec	mm 80		

An aluminium ring runs around the dome for easier positioning

30783

Aluminium structure tested for over 40,000 movements

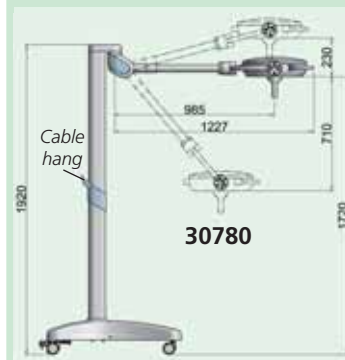

30780

RIMSA

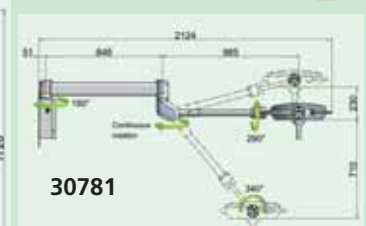

30781

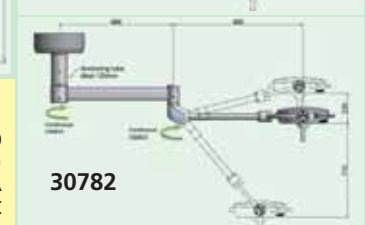

30782

## TRIS LED LIGHTS - 130,000 LUX

### SHADOWLESS THEATRE LED LIGHT

Shadowless lamp with exceptional technical performance and flexibility of use. Suggested for small surgery, gynaecological and first aid surgeries. Cupola with four inner modules, each with 7 LEDs (total of 28 LEDs) displayed in a radial layout with lenses allowing shadowless and deep light. LEDs modules guarantee continuous light, even in the unlikely event that a LED should fail. Extremely easy to handle and stable in position. Focusing and adjusting the diameter of the illuminated area takes place by rotating the sterilizable handle at the centre of the reflector.

**Battery group with charger:** 4 hours autonomy, 6 hours recharging.

#### TECHNICAL SPECIFICATIONS

Light intensity: 130,000 lux at 1 m distance  
 Diameter of the reflector: 40 cm  
 Adjustable diameter of illuminated field: 26-38 cm  
 Depth of illumination IEC 60601-2-41 (L1+L2) at 20%: 148 cm  
 Depth of illumination IEC 60601-2-41 (L1+L2) at 60%: 82 cm  
 28 LEDs - life 50,000 hours  
 Colour temperature: 4,300° K ± 5%  
 CRI 96 (Chromatic Rendering Index)  
 Power supply: 100-240V - 50/60 Hz - 70 VA  
 Total radiated energy Ec 460 W/m<sup>2</sup>  
 Weight (ceiling, mobile, wall) kg: 35 - 32 - 27  
 Minimum height of the room (ceiling version): 260 cm  
 Norms: IEC 60601-1, IEC 60601-2-41 - MDD 93/42/EEC  
 Made in Italy Warranty: 12 months  
 mechanical components warranty: 10 years



49110

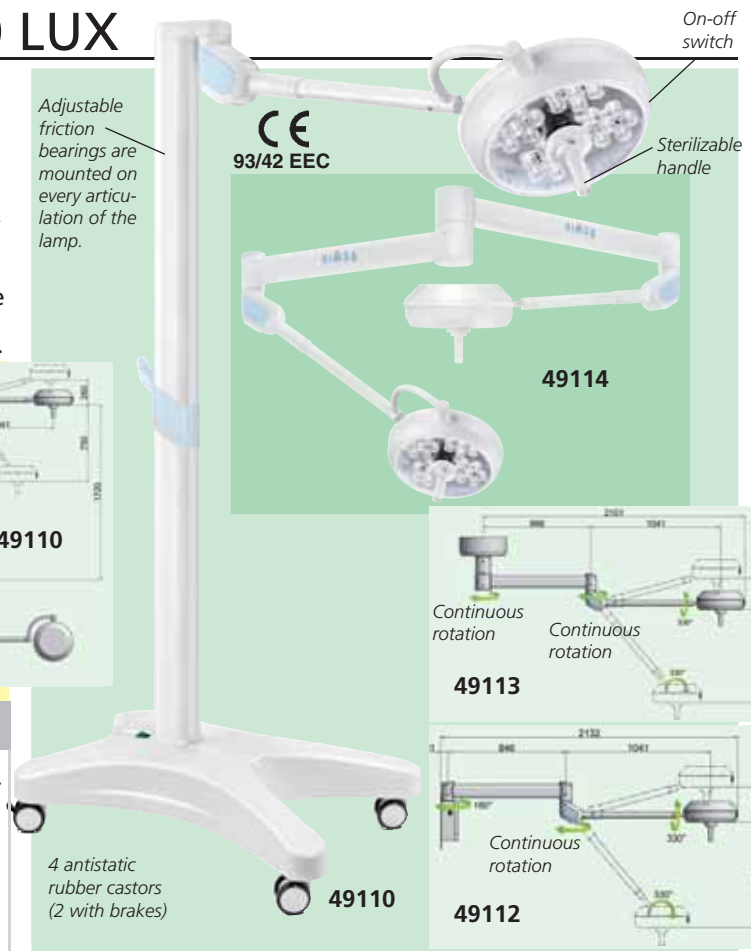

GIMA code	TRIS SCIALYTIC LED LIGHTS
49110	Scialytic light - mobile stand
49111	Scialytic light - mobile with battery group and automatic charger
49112	Scialytic light - wall
49113	Scialytic light - ceiling**
49114	Scialytic light double - ceiling**
49220	Special structure for ceiling >3.80 m
30738	Spare autoclavable handle - for scialytic 3 bulbs

Battery group available on request for all models\*

\*to be ordered with light

\*\*Ceiling >3.80 m needs 49220

## SATURNO LED LIGHTS - 30,000 LUX



### SATURNO LED MINOR SURGERY LAMP

SATURNO is a shadow-less type lamp suitable for small surgery, gynaecology and examination.

Available in three versions: mobile with castors, wall and ceiling.

- light beams are generated from 9 LEDs - 2.5 W each
- heat is dissipated through aluminium cover reflector
- selection of 2 different white light temperatures: 5,000 °K and 4,500 °K
- light intensity adjustable at 6 different levels through front digital panel
- luminous intensity 30,000 LUX at 1 m. Diameter of illuminated field 28 cm
- adjustable friction bearing are mounted on every articulation of the lamp
- thanks to optical concept, no need to be focus adjusted

**Battery group with charger:** 4 hours autonomy, 6 hours recharging.

#### TECHNICAL SPECIFICATIONS

Light intensity at 1 m distance	Lux	30,000
Colour temperature adjustable	K°	4,500/5,000 ± 5%
9 LEDs	W	2.5 each
Average LED life	hours	50,000
CRI (chromatic rendering Index)	Ra	96
Diameter of illuminated field	Ø cm	28
Depth of illumination IEC 60601-2-41 (L1+L2) at 20% of Ec	cm	228
Depth of illumination IEC 60601-2-41 (L1+L2) at 60% of Ec	cm	136
Total radiated energy Ec	W/m <sup>2</sup>	105
Diameter of the reflector	cm	19.5
Useful lighting surface of the cupola	cm <sup>2</sup>	65
Weight (ceiling, mobile, wall)	kg	12 - 14 - 13
Power requirements	V, Hz	100-240, 50-60
Minimum height of the room (ceiling version)	cm	244
Standards: IEC 60601-1 IEC 60601-2-41, MDD 93/42 CEE, medical device of Class I		
Warranty 12 months - mechanical components warranty 10 years	Made in Italy	

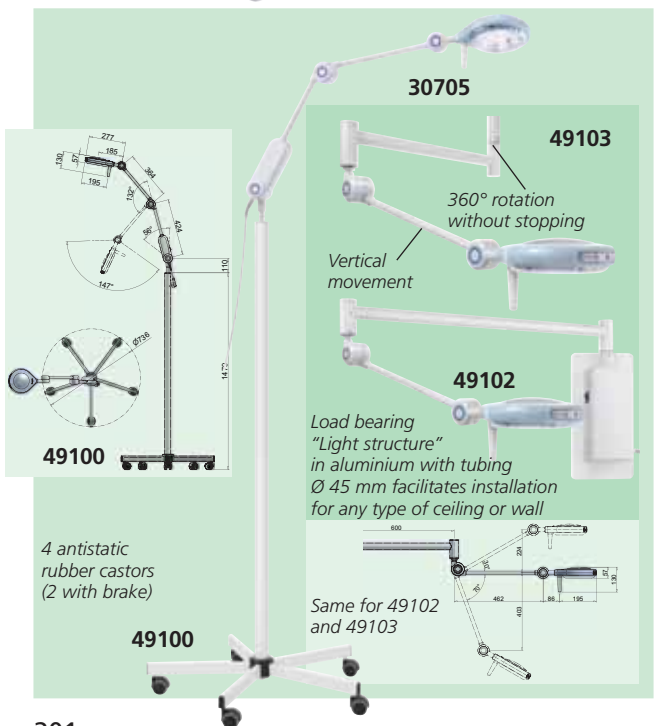

GIMA code	SATURNO LED LIGHTS
49100	Saturno LED light - mobile stand
49101	Saturno LED light - mobile stand with battery group
49102	Saturno LED light - wall
49103	Saturno LED light - ceiling*
49105	Special structure for high ceiling (>3.20 m)
30797	Spare autoclavable handle for Saturno

Battery group with automatic charger available on request for all models (to be installed at order)

\*Ceiling >3.20 m needs 49105

# PENTALED 12 - 100,000\* LUX, PENTALED 28 - 120,000 LUX

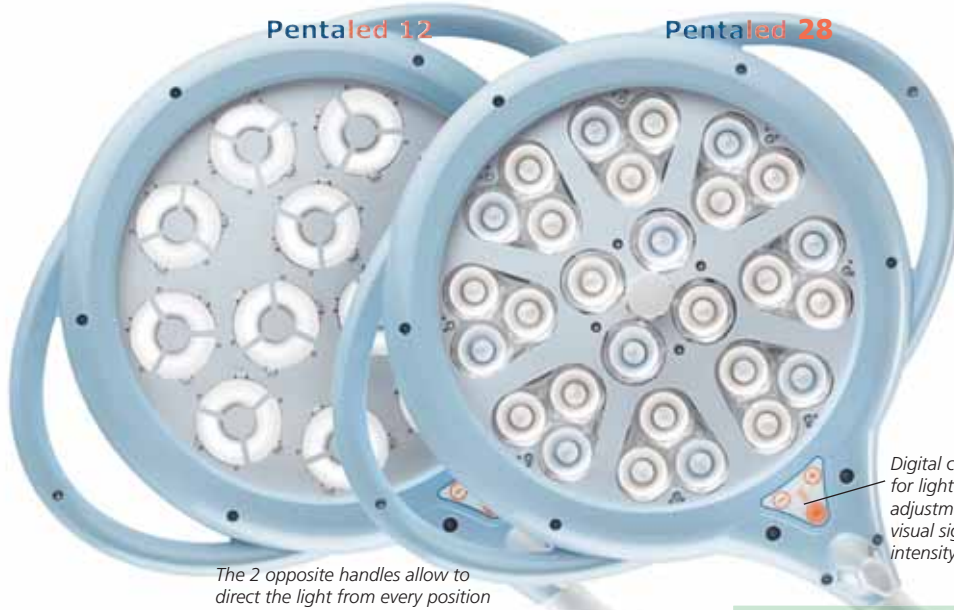

## PentaLED 12

- 100,000\* Lux at 1 m
- indirect light with 12 elliptic reflectors. They reflect the light rays emitted by the LEDs. Does not dazzle and does not strain eyes.

\*Since January 2018. 70,000 Lux up to December 2017

## PentaLED 28

- 120,000 Lux at 1 m
- direct light with 28 LED lens
- double colour selection: 4,500 or 5,000 K
- light field adjustment

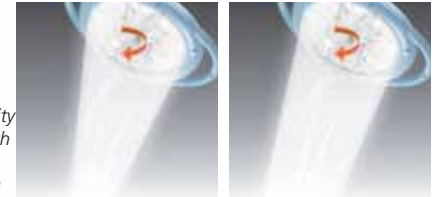

Digital control for light intensity adjustment with visual signal of intensity set up

Light field adjustment for PENTALED 28

The 2 opposite handles allow to direct the light from every position

### PENTALED

PENTALED is a perfect combination of technological developments, innovation, ergonomics and compact design, ultra-light and handy structure. Five versions available (trolley, ceiling, ceiling double, trolley with battery group and wall) and technical performances make PENTALED suitable for precision operations, diagnostic use, surgical rooms and small surgeries. Battery group, with an autonomy of 3 hours, is available on request also for wall and ceiling models.

### Cold LED light

Bright and cold light reproduces colours faithfully, assuring excellent definition of details.

### Ergonomic

- the dome has a full-circle 360° rotation
  - the arm moves vertically thanks to a spring balancing system
  - the reflector can be rotated on the vertical and horizontal axis.
- Movements are possible through the sterilizable handle.

### 50,000 hours life time

The low power supply current and the heat dispersion through aluminium dome allow the LED a 50,000 hours lifetime.

### Light intensity adjustment

Light intensity adjustable through digital control



The ultra-flat lighting body is equipped with ultra-resistant polycarbonate screen which guarantees protection against accidental collisions.



The dome can be adjusted by the sterilizable handle

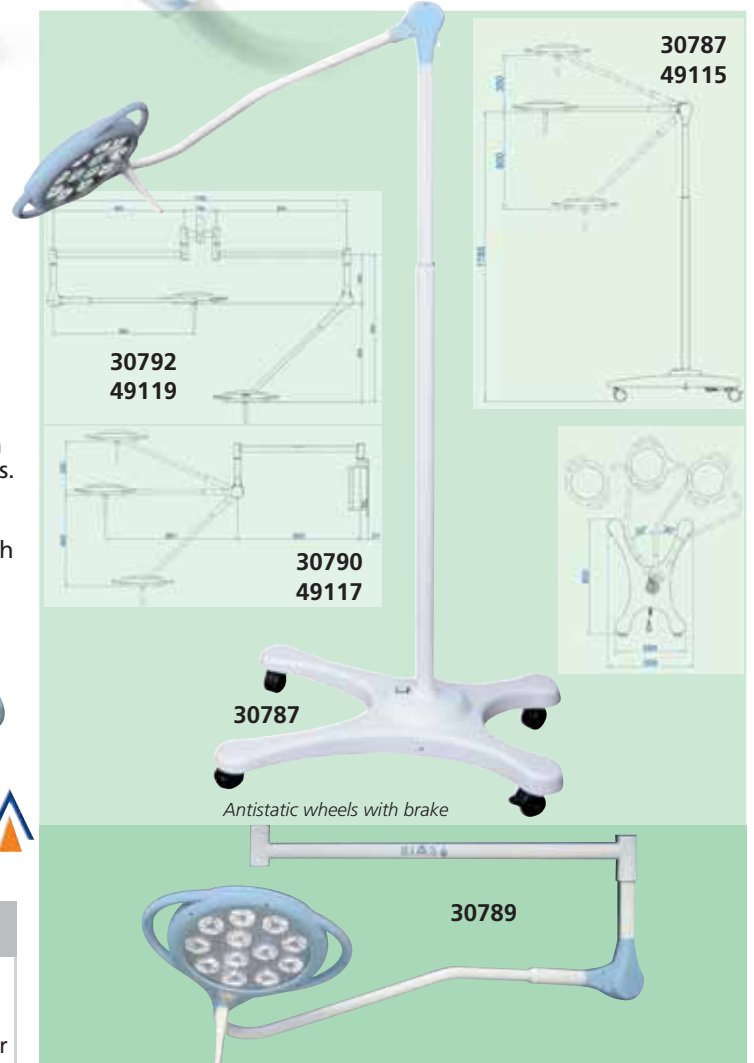

GIMA code	PENTALED 12 LEDS
30787	PentaLED 12 - trolley
30789	PentaLED 12 - ceiling* (for ceiling 2.57 to 3.33 m)
30790	PentaLED 12 - wall
30791	PentaLED 12 - trolley with battery group and automatic charger
30792	PentaLED 12+12 - ceiling* double
30788	Special structure for ceiling > 3.34 m
30793	Autoclavable handle - spare
GIMA code	PENTALED 28 LEDS
49115	PentaLED 28 - trolley
49116	PentaLED 28 - ceiling* (for ceiling from 2.57 to 3.33 m)
49117	PentaLED 28 - wall
49118	PentaLED 28 - trolley with battery group and automatic charger
49119	PentaLED 28+28 - ceiling* double
30788	Special structure for ceiling > 3.34 m
30793	Autoclavable handle - spare

\*Ceiling >3.34 m needs 30788

	TECHNICAL SPECIFICATIONS	
	PENTALED 12	PENTALED 28
Light intensity at 1 m distance	Lux 100,000	120,000
Colour temperature	K° 4,500	4,500/5,000
LED	No. 12	28
Average LED life	hours 50,000	50,000
CRI (Chromatic rendering Index)	Ra 96	92 (5,000K) 96 (4,500K)
Diameter of illuminated field	Ø mm 160	135-270
Depth of illumination (L1+L2) at 60%	cm 87	58
Total radiated energy Ec	W/m² 350	404
Weight (ceiling, mobile, wall, double)	kg	18-13-12-20
Power supply	V/Hz	100-230V, 50-60Hz

Standards: IEC 60601-2-41, 2007/47/EEC, medical device of Class I

## PRIMALED COLD LIGHT LAMP - 80,000 LUX AT 50 cm

### PRIMALED COLD LIGHT LAMP WITH 9 LED LENSES

Appealing design and advanced technology.

**Design:** the round and ultra-flat shape of the light makes the product ergonomic and suitable for any type of installation, from the doctor's surgery to the intensive-care unit.

**Ergo-Spring:** the movement of the articulated tubular arm is servo-assisted by a torsion spring which ensures ease of movement and stability.

**80,000 lux:** unique performance with 80,000 lux at 50 cm.

**Light intensity adjustment:** six different adjustment levels by the keys on the frontal panel.

**4,500-5,000 °K Colour temperature selection:** the comparison between the two colours (K) increases the visibility of details.

**Shadow suppression:** the radial layout of the lenses and the large-diameter lamp (195 mm) allow shadow suppression and three-dimensional lighting.

**Adjustable courtesy-light:** integrates ambient light with traditional concentrated light.

**Sterilizable removable grip:** allows best asepsis.

**Cold light:** the reduced emission of IR rays by the LEDs as well as the low power consumption allow minimum heat emission.

**Disinfection:** the smooth and rounded shape of the dome and structure make it easy to clean and disinfect.

**50,000 hours LEDs life:** the top aluminium dome allows heat exchange, thus reducing the work temperature and considerably increasing the life cycle of the single LEDs.

**Fully certified:** complies with IEC 60601-1 and 60601-1-2 general medical standards and to special standard IEC 60601-2-41 93/42 EEC and 2007/47 EC and is CE marked as a Class I medical device.

**Mechanical testing and user safety:** die-cast aluminium and tubular steel structure. The articulated arm has undergone mechanical testing for 40,000 continuous movements to ensure maximum safety for the user during use.

**Light continuity:** the modular design of the LED power circuit ensures light continuity even in case of a LED fault.

GIMA code	PRIMALED
30777	Primaled light - trolley
30753	Primaled flex light - trolley
30778	Primaled light - ceiling* (for ceiling 2.44 to 3.20 m)
49105	Special structure for high ceiling (>3.20 m)
30784	Primaled light - wall
30786	Primaled light - rail (25x10) and clamp
30797	Autoclavable handle
	Battery group available on request

\*Ceiling >3.20 m needs 49105

#### TECHNICAL SPECIFICATIONS

LED life: 50,000 hours  
 Light intensity: 80,000 lux at 50 cm, 20,000 lux at 1 m  
 Colour temperature: 4,500-5,000 °K Colour rendering index: 95 Ra  
 Illuminated field at 50 cm: Ø 140 mm  
 External diameter of the reflector: 190 mm  
 Temperature increase in the operating area at 1 m: 1°C  
 Adjustable height with castors: 600 mm - max 1,600 mm  
 Power supply: 80-240V - 50/60 Hz Electric absorption: 21VA  
 Weight: 10 kg (trolley included) Made in Italy



The following functions are controlled by the keys on the membrane keyboard:

- on/off
- selection of the 5,000°K and 4,500°K colour temperatures
- 6-level adjustment of the light intensity
- courtesy light



## RI-MAGIC® HP LED LIGHT

- 49050 RI-MAGIC® HP LED - desk
- 49051 RI-MAGIC® HP LED - trolley
- 49052 RI-MAGIC® HP LED - wall

High performance medical LED light for examination and procedures.

- high performance LED, 6,500 °K
- lifetime of the lamp up to 50,000 hours
- significantly reduced heating and energy loss

- focusing device at the front of the light head

- highly flexible, long special arm can be bent in all directions

- rheostat handle for infinitely variable regulation of light intensity.

Manual in: GB, FR, IT, ES, DE, RU.

Made in Germany.



49051

Sturdy mobile base made of fiber glass and chrome plated pole.

Low friction antistatic castors with brake  
 Ø 53 cm mobile base



#### TECHNICAL SPECIFICATIONS

Distance:	1,000 mm	800 mm	600 mm	400 mm	200 mm
Lux max:	15,000	20,000	30,000	45,000	55,000
Circle of light max Ø:	340 mm	270 mm	215 mm	155 mm	90 mm
Circle of light min Ø:	40 mm	35 mm	30 mm	25 mm	20 mm
Operating voltage:	100-240 V,	50-60 Hz			

## MONOLED LED LIGHT

- 30715 MONOLED LED LIGHT - on trolley

High performance LED light for minor surgery and examination. Flexible arm and versatile use.

Arm length 70 cm (35 cm flexible, 35 cm rigid).

Supplied on sturdy 5 castors stand for easy movability. Schuko plug. Made in Italy.

#### TECHNICAL SPECIFICATIONS

Consumption:	16 W
Life of the bulbs:	30,000 hours
Light intensity at 50 cm:	40,000 lux
Colour temperature ± 5% at 1 m:	7,000 °K
External Ø of the reflector:	120 mm
Colour:	cold white
Weight:	11 kg
Operating voltage:	175-250 V
Operating Hz:	50/60 Hz
Norms:	IEC 60601-1

40,000 LUX

CE 93/42



# HALOGEN AND LED LIGHTS FOR EXAMINATION AND MINOR SURGERY

**WITH 2 BULBS**

**40,000 LUX**

Electronic transformer integrated in the base with double safety fuse

Adjustable height 60-160 cm

**30747**

**RIMSAL**

**35,000 LUX LED**

**30759**

The flexible arm (60 cm) ensures easier light positioning and is covered with a smooth white shrink-wrap sheath for easier cleaning and disinfection

**30,000 LUX HALOGEN**

**30760**

Adjustable height 60-160 cm

**30760**

Manual in: GB, FR, IT, DE, ES, PT

**50,000 LUX - Halogen**  
**15,000 LUX - LED**

**MIMSAL**

**30754**

**30756**

Adjustable height 60-160 cm

**30754**

Height 50 cm (arm) + 95 cm (trolley)

- **30747 SOLESUD 2 on trolley - halogen**
  - **30748 SOLESUD 2 wall - halogen** (B)
- Suitable for gynaecology, examination and head-bed. Aluminium reflector equipped with 2 halogen dichroic bulbs, 20W 12V 10° IRC protected by a tempered glass, hermetically sealed against dirt and fluid spray and with ergonomic handle for movement. Bulbs switch on simultaneously and, in case one breaks, light is always assured. Arm movement servo-assisted by a torsion spring provides lightweight movement and stability of position. A light beam of 180 mm diameter at a distance of 50 cm allows precise and reliable examinations. Base with 5 rotary spokes, 900 mm high. 3 Pin British Plug available on request. Made in Italy.
- **30769 SPARE TROLLEY - base Ø 61 cm**
  - **30775 RAIL CONNECTION WITH CLAMP**
  - **30764 SPARE BULB SOLESUD 2 - 20 W**

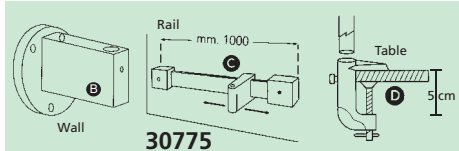

- **30760 SIMPLEX on trolley - halogen**
  - **30761 SIMPLEX wall** (B) - halogen
  - **30762 SIMPLEX table with clamp** (D)
  - **30763 SIMPLEX rail** (C) - halogen
- Versatile lamp equipped with a halogen dichroic bulb 35W 12V placed inside the aluminium reflector and protected by a tempered glass. Electronic transformer integrated in the base with lead retainer with spiral protection and bipolar light switch with green indicator light. Ceramic fuse offers extra protection.
- **30759 SIMPLEX on trolley - LED**
  - **30749 SIMPLEX wall** (B) - LED
  - **30752 SIMPLEX table with clamp** (D) - LED
- Thanks to 3 independent light sources shadow can be reduced and provide a deep cylindrical light with highly reduced heat irradiation. Each LED integrates a resistance to ensure the continuous operation of the lamp even in the rare case of a LED fault. Other specifications as halogen model. Made in Italy.
- **30766 SPARE BULB SIMPLEX - IRC 35 W**
  - **30768 SPARE TROLLEY - base Ø 62 cm**
  - **30775 RAIL CONNECTION WITH CLAMP**

- **30754 LUXIFLEX on trolley - halogen**
  - **30756 LUXIFLEX on trolley - LED**
- Stylish and versatile light for examination and minor surgery procedures in health-centres, clinics and hospitals. Suitable also for veterinary examinations and procedures. Safe low voltage operation without infrared radiation. Electronic transformer lodged at the bottom of the lamp. Flexible arm and 5 castors trolley allow easy use and movability. Class II. Made in Europe.
- **30757 SPARE BULB LUXIFLEX - halogen**

**30712**

4 hours on, 30 min off 3 pin plug

**37,000 LUX**

**30714**

Continuous use Schuko plug

**20,000 LUX**

Arm length 70 cm (35 cm flexible 35 cm rigid)

**30714**

Model	SOLESUD 2		SIMPLEX		LUXIFLEX		MINIMED 2	
Type of lighting	halogen	halogen	halogen	LED	halogen	LED	halogen	LED
Consumption (Watt)	2x20	35	35	3x1.4	35	10	50	7
Life of the bulbs (hours)	5,000	5,000	5,000	50,000	5,000	25,000	7,000	30,000
Light intensity at 50 cm (lux)	40,000	30,000	30,000	35,000	50,000	15,000	37,000	20,000
Light intensity at 1 m (lux)	8,000	8,000	8,000	13,000	-	-	-	-
Colour temperature ± 5% at 1 m (K)	3,000	3,000	4,200	4,000	3,000	3,100	7,000	-
Light field size at 50 cm (Ø mm)	180	100	140	-	-	-	-	-
External Ø of the reflector (mm)	140	105	86	-	-	-	60	60
Colour	white	white	white	white	white	white	cold white	cold white
Norms	IEC 60601-1	IEC 598-2-25	IEC 60601-1	EN 60601-1-2	EN 60601-1-2	IEC 60601-1	IEC 60601-1	IEC 60601-1
Marks	CE 93/42	CE 2006/95	CE 93/42	CE 93/42	CE 93/42	CE 93/42	CE 93/42	CE 93/42
Weight (kg)	6	5	5	-	-	-	9	9
Operating voltage V	230	230	100-230	230	230	230	230	190-265
Operating Hz	50/60	50/60	50/60	50	50	50/60	50/60	50/60
Operating voltage on request V-Hz	-	-	-	110-60*	110-60*	-	-	-

\*minimum 50 pcs.

- **30712 MINIMED 2 ON TROLLEY - halogen**
  - **30714 MINIMED 2 ON TROLLEY - 12 LED**
- Low voltage and high definition, intense light. Flexible arm for versatile use. Supplied on a sturdy 5 castors stand for easy movability. Made in Italy.
- **30744 SPARE BULB - 50 W - halogen**

## MAGNIFYING FLUORESCENT COLD LIGHTS - 3 DIOPTRES

### GIMANORD

Magnifying glass self-illuminating fluorescent cold light 3 dioptries (0.75X). Suggested for dermatology and whenever magnifying is required. It is equipped with a biconvex magnifying lens in optical glass Ø 120 mm. The cold fluorescent light allows prolonged use. Polycarbonate screen for protection of the light source. Available also with wall support. Medical device Class I.

#### TECHNICAL SPECIFICATIONS

Type of lighting	fluorescent
Consumption	22 W
Life of the bulbs	6,000 hours
Light intensity at 50 cm	550 lux
Colour temperature	4,550 °K
External diameter of the reflector	230 mm
Temperature increase at 1 m	0 °C
Norms	IEC-60601-2-41
Marks	CE 93/42
Weight	7 kg
Operating voltage V-Hz	220-240 V, 50 Hz
Adjustment height with castors base:	
min-max	60-180 cm



Magnifying glass  
Ø 120 mm

**30750**

GIMA code	MAGNIFYING LIGHTS
<b>30750</b>	GIMANORD desk model - with clamp
<b>30751</b>	GIMANORD on trolley
SPARES AND FIXING SYSTEMS	
<b>30767</b>	Spare fluorescent lamp - 22 W
<b>30771</b>	Spare plexiglass shield
<b>30769</b>	Trolley - spare (A) - base Ø 61 cm
<b>30774</b>	Wall connection (B)
<b>30775</b>	Rail connection with clamp (C)
<b>30776</b>	Table connection (D)

**FIXING SYSTEMS**

On request we can supply all lamps with wall, table or rail (1,000 mm) connection

## LED MAGNIFYING LAMP - 5 DIOPTRES

### • 30737 LUPA LED MAGNIFYING LIGHT - trolley

### • 30739 LUPA LED MAGNIFYING LIGHT - desk with clamp

Smartly designed cold light LED lamp with 5-dioptres magnification. Generates a light without shadow. 5 wheels base and articulated arm allow easy movement. Manual in GB, FR, IT, ES, PT, DE. Medical device Class I Made in Europe.

#### TECHNICAL SPECIFICATIONS

Type of light:	80 LED - HF 8 W
Dioptres:	5
Lens:	Ø 12.7 cm
Colour temperature:	6,500 °K
Operating voltage:	230 V - 50 Hz
Class I	
Electrical security:	UNI EN 60601-1 (1990)
Electromagnetic compatibility:	
	EN 60601-1-2 (1993)
Lamp life:	40,000 hours



## LED MAGNIFYING LAMP - 3 DIOPTRES

### • 30736 DERMALED MAGNIFYING LAMP

Cold light LED lamp with 3 dioptries magnifying lens and brightness adjustment.

It comes with a high stability 5 wheels base and an articulated arm for easy movement and fixing of the lamp. Made in China.

#### TECHNICAL SPECIFICATIONS

Type of light:	LED
Voltage:	8 W
Dioptres:	3 (large glass)
Colour temperature:	8,000-9,000 °K
Light intensity at 20 cm:	2,000 lux
Operating voltage:	100-240 V - 50/60 Hz
Net/Gross weight:	10-12 kg

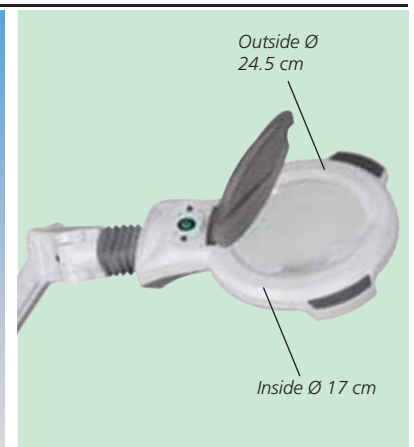

## VISTA WOOD BLUE LIGHTS: TROLLEY AND MANUAL

- 31196 VISTA WOOD LAMP - handle
  - 31197 VISTA WOOD LAMP - trolley
- A Wood lamp is a diagnostic tool to diagnose the condition of skin. Different skin conditions under ultraviolet rays of the Wood lamp appear in different colours. These models have polished glass magnifying lens 10x6 cm - 3 dioptries. 9W special compact fluorescent tube at approximately 360 nm wavelength. Operating voltage: 230 V - 50 Hz. Manual in GB, FR, IT, ES, PT, DE. Made in Spain.
- 31201 FLUORESCENT TUBE 9W - spare for 31196-31197



## MACRO LENS 12X

- 31155 SMARTPHONE MACRO LENS 12X
- Macro lens 12X for allergists, dermatologists, phlebologists, aesthetic surgeries. Can be mounted on any smartphone to take magnified images. Supplied with clip compatible with any smartphone, 10x10 cm wipe and multilanguage manual (GB, FR, IT, ES, PT, DE, PL, GR).



## ECONOMIC WOOD LAMP



- 31200 WOOD LAMP
- Ultraviolet light for skin condition analysis. Size 30x21x7 cm. Made in China.
- 31202 FLUORESCENT TUBE - spare

## POCKET WOOD LIGHT



- 31189 POCKET WOOD LIGHT
- Pocket ultraviolet light, to detect skin disorders. Provided with replaceable fluorescent lamp. Power 6 V. Works with 4xAA batteries with 4-6 hours autonomy.
- 31190 FLUORESCENT TUBE - spare

## DIGITAL Wi-Fi POLARISED DERMATOSCOPE, CAPILLAROSCOPE, MICROSCOPE

An innovative line of handheld colour digital microscopes: dermatoscope with polarized filter, capillaroscope and iridoscope with Wi-Fi wireless transmission. Small, easy to operate light and portable. They can be used with all the most popular smartphones, tablet and PC.

Basic software for acquisition of photos, videos, measurements google/apple applications included. Designed in Italy, manufactured in China. Directive 93/43/CEE - Medical device Class I (only 32181 and 32183).



- 32181 Wi-Fi DERMATOSCOPE with polarized filter
- 32182 PROFESSIONAL SOFTWARE for 32181

DERMATOSCOPE SPECIFICATIONS	
Magnification:	5X to 200X
Light source:	8 adjustable white LED
Lens:	High definition microscopy lens



- 32183 Wi-Fi CAPILLAROSCOPE

CAPILLAROSCOPE SPECIFICATIONS	
Magnification:	500X to 600X
Light source:	8 adjustable white LED
Lens:	High definition microscopy lens



- 32184 Wi-Fi MICROSCOPE
- Advised for iris scanning

MICROSCOPE SPECIFICATIONS	
Magnification:	30X
Light source:	2 adjustable white LED+ 2 adjustable yellow LED
Lens:	High definition microscopy lens

TECHNICAL SPECIFICATIONS		
Operation system	Windows (XP and following), Mac (OSX 10.7 following), iOS, Android (it can be used by Wi-Fi or USB)	<b>CAMERA</b>
Photo and video resolution	1.3 MPixels - 1280x1024 (MJPG), 640x480 (MJPG), 320x240	Camera sensor CMOS 1/4"
Frame rate	15 fps 1,280x1,024, 30 fps 640x480 320x240	Optical features Exposure: Auto, Gamma: Auto, White balance: Auto, Black reference: Auto
Wi-Fi wireless transmission distance	Up to 5 m	
Power consumption	Max 2.5 W	
Li-ion battery	Continuous working time - appx. 2 hours, full charging time - appx. 2 hours	<b>PROFESSIONAL SOFTWARE</b>
Power source - Size - Weight	DC 5.0V 7 1A - Ø 36x142 mm - 88 g	Operation system: Windows XP and next Software language: GB, IT

STANDARD ACCESSORIES	
Caps of contact (only for 32181)	
USB AC adapter	
USB cable	
Quick manual	
Plastic stand	
Line calibration ruler	
Manual (GB, FR, IT, ES, DE)	
CD basic software Win (GB, IT, ES, DE, PT, RU, BG, TH, JP, KR), Mac (GB)	

## HEINE DELTA 20® T LED<sup>HQ</sup> DERMATOSCOPES 10X - 16X

- 31165 HEINE DELTA 20® T LED<sup>HQ</sup> DERMATOSCOPE 2.5V for polarization and immersion - K-262.10.118
- 31161 HEINE DELTA 20® T LED<sup>HQ</sup> DERMATOSCOPE 3.5V (Li-ion) for polarization and immersion with rechargeable handle for mains socket and USB cable - K-262.28.388

Precision HEINE Optics - high quality, achromatic optical system provides unsurpassed sharpness and resolution. Focusing system provides from 10X to 16X magnification for detection of even the smallest details and structures.

**LED in HQ** - the new standard in LED illumination defining optimal light intensity, homogeneity and colour rendering for each individual examination - Colour temperature: 5.000 K, Colour Rendering Index (CRI) > 80 on a scale of 100. This ensures true tissue colour for the most accurate diagnosis.

**Toggle between polarised and non-polarised illumination modes** - conveniently alternate between two modes with the press of a button - no exchange of contact plates necessary. Allows recognition of the "Blink Sign" when observing crystalline structures and presence of milia cysts, increasing diagnostic function.

**Optional small contact plate** for difficult to access lesions.

**Digital documentation capabilities** - Heine SLR photo adapter allows to connect any Delta 20 dermatoscope to major brands of digital cameras.

**LED Thermal Management** - ensure long-term performance and product stability. Carefully selected and applied heat-diffusing materials guarantee up to 50.000 hours.



Supplied with hard case, dermatology compendium, 10 ml oil.

- 31162 HEINE DELTA T LED DERMATOSCOPE HEAD with contact plate with graduated scale - K-008.34.221 (can be used with any Heine Beta handle). Supplied with compendium.
- 31179 SMALL CONTACT PLATE Ø 8 mm - K-000.34.205
- 31171 SLR PHOTO ADAPTOR - for Canon
- 31173 SLR PHOTO ADAPTOR - for Nikon
- 31174 SLR PHOTO ADAPTOR - for Olympus
- 31169 ADAPTOR CORD - 1.30 m
- 31183 DERMATOLOGY OIL - box of 4 bottles of 12.5 ml

## HEINE MINI 3000 DERMATOSCOPES

- 31184 HEINE MINI 3000 XENON-HALOGEN DERMATOSCOPE 10X - D-001.78.107
- 31160 HEINE MINI 3000 LED<sup>HQ</sup> DERMATOSCOPE 10X - D-008-78-109 - same as 31184, with the addition of:

Pocket dermatoscope with high-quality optics, 10X magnification with focusing optics, metal head.

**Xenon Halogen bulb.** Concentrated, bright light for uniform illumination with exact colour rendering.

**High quality colour-neutral optic system** with achromatic lenses, provides sharp images.

**Contact plate** without scale.

Supplied with dermoscopic compendium and oil. Operates with AA batteries or rechargeable batteries (31693) + Mini 3000 NT charger (31692) not included.

**High-performance bright and homogeneous LED illumination** with an excellent colour rendering (index >95). Colour temperature 4,000 K.

**Twice brighter light** compared to Xenon Halogen

**Maintenance free.**

**Fade-out function:** reduces illumination intensity with battery level to let you know when to replace.

**Up to 10 hours operation time.**

- 31692 HEINE MINI 3000 NT CHARGER - X-001.99.484
- 31693 BATTERY+BASE - X-001.99.487 + X-001.99.488



## HEINE NC1 LED DERMATOSCOPE

- 31158 HEINE NC1 LED<sup>HQ</sup> DERMATOSCOPE - D-008.78.132

**LED thermal management** - LED illumination systems require thermal management. Carefully selected heat-diffusing materials guarantee consistent quality and performance for up to 50.000 hours.

**Aluminium frame** - more stability to the device for a long working life.

**Non-Contact Dermatoscope** - examining patients without touching the skin saves time and provides more professional distance between examiner and investigation area.

**Polarised Illumination** for detailed views of the crystalline and vascular structures. Allows examinations without contact liquids.

**Precision HEINE Optics with 6X magnification** - high-quality, aspherical optical system provides unsurpassed sharpness and resolution.

**LED in HQ** - optimal light intensity, homogeneity and colour rendering for each individual examination - Colour temperature: 5,000 K, Colour Rendering Index (CRI) 80, special index for red colours (R9) 35 on a maximum scale of 100. This ensures true tissue colour for the most accurate diagnosis.

**Optional Contact Plate with additional magnification** - adding the contact plate transforms NC1 in a contact dermoscopy, increasing magnification (9X) plus offering a scale. It combines the speed and ease of use of non-contact dermoscopy with the detail and precision of a contact device.

- 31159 CONTACT PLATE WITH SCALE - D-000.78.115



## GIMA XENON HALOGEN SKIN SURFACE MICROSCOPE 10X

- 31187 GIMA XENON HALOGEN DERMATOSCOPE 2.5 V - 10X
- 31183 DERMATOLOGY OIL
- 32203 "C" BATTERIES - blister of 2 pcs.
- 31479 XENON HALOGEN BULB - 2.5V - spare
- 31185 SKIN LESION GAUGE - 21x5 cm

Advanced skin surface microscope offers long-lasting halogen illumination for the true tissue colour and 10X magnification for greater details, allowing accurate diagnoses of pigmented skin lesion. Supplied in a useful bag, with spare autoclavable contact plate with 0-10 mm scale. Latex free.

Available with your logo for min. 2,000 pcs.



### TECHNICAL SPECIFICATIONS

Battery: 2x "C" or rechargeable battery (34479) + charger (31542)  
Reticle contact plate  
Easy to focus, with large focus ring

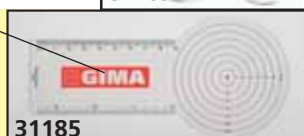

# MD SCOPE VIDEO OTOSCOPE

## MD SCOPE VIDEO OTOSCOPE

### Instant View

A clear and sharp image can be acquired and displayed instantly on a built-in screen. Just press a single button and wait for 3 seconds.

### Real Time Interaction

The medical image can be captured and shared simultaneously with patients. A true improved interaction between the health professionals and the patients.

### Electronic medical record

A medical image is automatically generated to support most of the stand-alone health information system. Simply plug the cable into the video-out socket to retrieve the image.



32160



32162

### • 32160 ELITE PACK

- MD Scope with
- 1 camera probe 45 mm Ø 5.2 mm
- RCA video cable
- 24 disposable specula
- 2 AA alkaline battery

### • 32161 DELUXE ZIPPER PACK - 2 cameras

### • 32162 DELUXE ZIPPER PACK - 4 cameras

- MD Scope with
- 2 camera probes 45 (Ø 5.2 mm)/150 (32161)
- 4 camera probes 45 (Ø 5.2 mm)/75/150/300 mm (32162)
- image dongle (32162 only)
- cable set (32176): USB and RCA cable, adaptor for image dongle
- 24 disposable specula
- 2 AA alkaline batteries



Detachable camera modules are designed for different examinations as needed

32165 32167 32168 32169

A video port provides simultaneous image to display on TV/monitor or to download to Mac/PC system



Image dongle



2.4" colour LCD display

Image freeze function

Video out port

320x240 pixels

Lightweight: 218 g

Size: 8x20 cm (2.5"x8")

Battery lifespan: 4 hours



US pat. n° 8206290



32175

GIMA code	ACCESSORIES AND SPARE PARTS
32165	Camera probe 45 x Ø 5.2 mm
32166	Camera probe 47 x Ø 4.2 mm
32167	Long camera probe 75 x Ø 5.2 mm
32168	Flexible camera probe 150 x Ø 5.2 mm
32169	Long flexible camera probe 300 x Ø 5.2 mm
32172	Disposable rigid specula Ø 5.5 mm for 32165 - box of 250
32173	Reusable silicone specula Ø 4.2 mm for 32166 - box of 24
32175	Cradle for video otoscope
32176	Cable set (USB and RCA cable, adaptor)

# DIGITAL Wi-Fi & USB VIDEOTOSCOPE + SOFTWARE

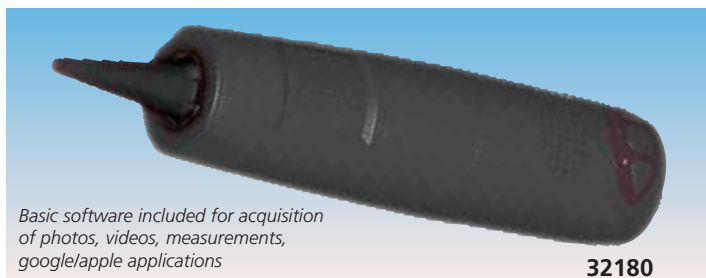

Basic software included for acquisition of photos, videos, measurements, google/apple applications

32180

• **32180 MIC Wi-Fi & USB VIDEOTOSCOPE with software**  
Innovative, handheld colour digital Otoscope with Wi-Fi wireless transmission. Small, easy to operate, light and portable. It can be used with all the most popular smartphones, tablets and even with PC. Designed in Italy, made in China.

• **31491 DISPOSABLE MINI EAR SPECULUM Ø 2.5 mm - black - box of 100**

• **31492 DISPOSABLE MINI EAR SPECULUM Ø 4 mm - black - box of 100**

Suitable also Mini Ear Speculum 31485-8, 31495-9 at page 220

## TECHNICAL SPECIFICATIONS

Operation system:	Windows (XP and following), Mac (OSX 10.7 and following), iOS, Android
Photo and video resolution:	1.3 MPixels - 1,280x1,024 (MJPG), 640x480 (MJPG), 320x240
Frame rate:	15 fps 1280x1024, 30 fps 640x480 320x240
Wi-Fi wireless transmission distance:	up to 5 m
Power consumption:	max 2.5 W
Li-ion battery:	continuous working time - approx. 2 hours, full charging time - approx. 2 hours
Power source:	DC 5.0 V / 1A
Size - weight:	Ø 36x142 mm - 88 g
<b>Camera</b>	
Camera sensor:	CMOS 1/4"
Optical features:	Exposure: Auto, Gamma: Auto, White balance: Auto, Black reference: Auto
<b>Otoscope</b>	
Magnification:	20 X
Focus range:	8-60 mm
Object distance:	1-160 mm
Light source:	4 adjustable white LED
Lens:	high definition microscopy lens
<b>Software interface</b>	Mic-Fi Apps for Android and iOS system and Mic-Fi softwares for PC and MAC

## STANDARD ACCESSORIES

Plastic stand	USB AC adapter and cable
Line calibration ruler	Manual (GB, FR, IT, ES, DE)
CD basic software Win (GB, IT, ES, DE, PT, RU, BG, TH, JP, KR) Mac (GB)	

## HEINE OMEGA® 500 INDIRECT OPHTHALMOSCOPE

### • 31753 HEINE OMEGA 500 XENON-HALOGEN INDIRECT OPHTHALMOSCOPE 6V - C-004.33.539

With mPack pocket battery, plug-in transformer, headband rheostat and 90° angled adapter  
 - clearer, crisper views: a new illumination system with Xenon Halogen Technology bulb produces less reflexes off the cornea and clear, high resolution bright images of the fundus.

- enhanced variable pupil function: allows for the precise, synchronized selection of observation and illumination optics for any pupil size. It provides stereopsis in pupils ranging from 10 mm to 1 mm.

- fully featured: 3 Spot sizes: Large, Medium and Small. Integrated diffused light filter.

3 Integrated Filters: Red-free, Cobalt Blue, and Yellow.

- Omega headband comfort: articulating Rear Hinge provides vertical adjustment of the rear band of the headband for individual placement.

### • 31756 HEINE OMEGA 500 UNPLUGGED LED™ INDIRECT OPHTHALMOSCOPE 6V - C-008.33.535

With mPack battery integrated in headband, plug-in transformer, headband rheostat and 90° angled adapter. Same feature as 31753 with in addition:

- LED technology: absolutely homogeneous, uniform illumination, up to 100% brighter compared with XHL (Xenon technology)

- rechargeable battery integrated on the headband

- mPack rechargeable battery: charging time 2 hours, operating time 8 hours

### • 31757 HEINE OMEGA 500 LED™ INDIRECT OPHTHALMOSCOPE WITH DV1 DIGITAL VIDEO CAMERA - C-008.33.561

with mPack UNPLUGGED with plug-in transformer

1280 x 960 imaging: capable of capturing High-Resolution video

- simple operation: digital imaging without any additional adjustments.

- comfortable and balanced fit: headband perfectly distributes the low weight of the camera and optics

- integrated focus adjustment

- interface and software: will plug into any laptop or computer via USB 2.0 interface. Supplied with software program for video recording and image capture. For more information see <http://dv1.heine.com>

- cable-free power source: system with mPack UNPLUGGED rechargeable battery.



5 YEARS WARRANTY

Light weight only 450g



31757

## WELCH ALLYN MACROVIEW™ OTOSCOPE

### • 32100 MACROVIEW™ HEAD - 23810

### • 32101 LITHIUM ION HANDLE WITH AC CHARGING MODULE 3.5 V - 71902

This next-generation otoscope features advanced optics that increase magnification while giving you a nearly full view of the tympanic membrane - virtually eliminating the need for panning. With its easy-to-focus eyepiece, MacroView allows for enhanced visualization to help see past wax, locate fluid behind the eardrum, and even perform exams without your glasses.

- twice the field of view

- 30% greater magnification than a traditional otoscope

- nearly a full view of the tympanic membrane

- better clarity and definition of landmarks

- ability to adjust focus for variable ear canal lengths or farsighted eyes

### • 32106 KLEENSPEC® ADULT DISPOSABLE EAR SPECULA 4.25 mm - box of 850 pcs - 52434-UB

### • 32105 KLEENSPEC® PEDIATRIC DISPOSABLE EAR SPECULA 2.75 mm - box of 850 pcs - 52432-UB

### • 32135 SPARE HALOGEN BULB - 3.5 V - 06500 U

Adjustable focus wheel allows to accommodate for variable ear canal lengths and farsighted eyes a full view of the tympanic membrane

Tip grip ensures ear specula is fastened securely and easily disposed

Default focus position (the dot and the line)

Advanced optics give you 2X the field of view and 30% greater magnification than a conventional otoscope



32100

Insufflation port for pneumatic otoscopy

Welch Allyn®



Lithium-ion handle with AC charger module compatible with all Welch Allyn instrument heads 3.5 V

32101

## WELCH ALLYN PANOPTIC™ OPHTHALMOSCOPE

### • 32110 PANOPTIC OPHTHALMOSCOPE HEAD - 11810

### • 32101 LITHIUM ION HANDLE WITH AC CHARGING MODULE 3.5 V - 71902

PanOptic is a breakthrough concept in ophthalmoscopy. Thanks to an innovative, optical design known as Axial PointSource™ Optics, it will greatly enhance your fundoscopic examinations.

- fast easy entry into small, undilated pupils

- 5X larger field of view than you see with standard ophthalmoscopes in an undilated eye

- 25° field of view versus the 5° field of view of standard ophthalmoscopy

- a 26% increase in magnification, making it easier to see retinal details

- greater distance between practitioner and patient means greater comfort for all

### • 32127 SPARE HALOGEN BULB - 3800 U

Patented Axial PointSource™ Optics: makes it easy to enter undilated pupils, and provides a 25° field of view, resulting in a view of the fundus 5 X greater than with a standard ophthalmoscope in an undilated eye

Halogen HPX™ Lamp: provides whiter, brighter light

Glare Extinguishment System: prevents interference from unwanted glare and reflections

Welch Allyn 3.5 V Power Sources: compatible with any standard 3.5 V power source including: desk charger handles, convertible battery handles, wall transformers and the Lithium Ion Power Handle



Patient Eyecup: allows proper viewing distance, provides image stability, serves as a pivoting point for panning around the retina, helps with orientation, and screens out ambient light. The eyecup is cleanable and reusable

PanOptic Soft Grip: ergonomically designed for maximum comfort, balance, and access to controls.

Aperture Dial: allows you to select micro, small, and large spot sizes. Also includes red-free filter and slit aperture, half-moon aperture for corneal exams

Dynamic Focusing Wheel: adjusts the focus in a continuous, smooth action for more precise control and optimum view. Available focusing range is -20 to +20 diopters

### FIELD OF VIEW



Larger view of the fundus

5X















Welch Allyn

## HEINE ORIGINAL BULBS

HEINE BULBS	HEINE ref.	GIMA code	Compatible with following HEINE products
 Xenon 2.5 V	035	31769	Transilluminator Finoff alpha <sup>®</sup> F.O. and F.O. SP Laryngoscopes - Sanalon handle Glaucotest
 Xenon 2.5 V	037	31771	K100 and Beta <sup>®</sup> 100, Beta <sup>®</sup> 100 vet otoscopes Laryngeal mirrors F.O. mini 2000 otoscope Alpha <sup>®</sup> and Alpha F.O. otoscopes Mini/mini 3000/Alpha/Beta tongue holders
	038	31773	Miroflex ophthalmoscope HFR2 spot retinoscope Delta <sup>®</sup> 10 dermatoscope
	041	31774	Fibralux mini otoscope Mini 2000 combilamp Mini 2000 cliplamp Mini 1000 cliplamp
	042	31780	Alpha <sup>®</sup> ophthalmoscope Mini 2000 ophthalmoscope Alpha <sup>®</sup> Focalux Mini Miroflex ophthalmoscope Mini 2000 Focalux
	056	31770	Minilux otoscope Mini 2000 otoscope
	057	31785	Mini 2000, Mini 3000 laryngeal mirrors
	069	31781	Beta <sup>®</sup> 200, 200 M2, 200S ophthalmoscopes - XHL 2.5 V
 Xenon 2.5 V	077	31772	Beta <sup>®</sup> 200, 200 VET, 400; K 180 otoscopes Lambda 100 retinometer Delta <sup>®</sup> 10 plus dermatoscope
 Xenon 2.5 V	084	31782	K180 <sup>®</sup> ophthalmoscope - 2.5 V
	105	31776	Mini 3000 F.O. otoscope
	106	31777	Mini 3000 ophthalmoscope
	107	31778	Mini 3000 combilamp and cliplamp - XHL 2.5 V
	109	31779	Mini 3000 dermatoscope
	110	31775	Mini 3000 otoscope
	070	31783	Beta 200, 200 M2, 200S ophthalmoscopes - XHL 3.5 V
	078	31784	Beta 200, 200 Vet, K180 otoscopes lambda 100 retinometer otoscopes - XHL 3.5 V

## RIESTER ORIGINAL BULBS

RIESTER BULBS	RIESTER ref.	GIMA code	Bulb	Compatible with following RIESTER products
	10421	31850	Vacuum 2.7 V	Otoscope uni <sup>®</sup> /speculight
	10424	31851	Vacuum 2.5 V	May-ophthalmoscope uni <sup>®</sup>
	10487	31825	XL 3.5 V xenon	Otoscope ri-scope <sup>®</sup> L1
	10488	31852	Vacuum 2.7 V	Pen-scope <sup>®</sup> and e-scope <sup>®</sup> otoscope
	10489	31560	HL 2.5 V	Otoscope pen-scope <sup>®</sup> / ri-scope <sup>®</sup> L1 and e-scope <sup>®</sup>
	10590	31853	HL 2.5 V	Otoscope uni <sup>®</sup>
	10600	31854	XL 2.5 V	Otoscope ri-mini <sup>®</sup> , ri-scope <sup>®</sup> L2/L3 and e-scope <sup>®</sup>
	10605	31562	HL 2.5 V	Ophthalmoscope ri-mini/ ri-scope <sup>®</sup> L1, L2, L3, e-scope <sup>®</sup> , ri-derma <sup>®</sup>
	10607	31855	XL 3.5 V	Ri-scope <sup>®</sup> otoscope L2, L3
	10608	31826	XL 3.5 V	Ri-scope <sup>®</sup> ophthalmoscope L1, L2, L3
	14041	31561	LED 3.7 V	E-scope F.O otoscope
	14051	31563	LED 3.7 V	E-scope ophthalmoscopes



## WELCH ALLYN BULBS

WELCH ALLYN BULBS	W. A. ref.	GIMA code	Compatible with following WELCH ALLYN products
	00200-U	32120	Anoscopes: 38800, 380, 385, 395 Illuminators: 41000, 26030 Old products: 235, 77900, 26000, 20100, 21600, 42700, 40510
	03000-U	32123	Ophthalmoscope: 11710, strabismoscope: 12400, episcope: 47300 Old ophthalmoscope: 11600, 11605, 11610 Retinoscope: 18000
	03100-U	32124	Otoscopes: 25020, 21700, 20200 Handle: 73500, holder: 28100 Illuminators: 27000, 27050, 26530, 41100, 43300 Old otoscopes: 25000, 25200, 20000
	03300-U	32125	Ophthalmoscope: 11511-11500
	03400-U	32126	Otoscopes: 24011-24020-24000-24031-21110/1 Handle: 73550, Illuminators: 27200-27250-41110
	03800-U	32127	Pan optic: 11810-11820-11800
	04100-U	32128	Exam light: 48400-48410
	04200-U	32129	Exam light: 48600, 48610-48625-48635, 48700
	04400-U	32130	Ophthalmoscopes: 11400-11411-11470-11475
	04700-U	32131	Laryngo: 680, 690, 692 (size 1-2) Old laryngo: 634, 664, 674, 684, 694 (check size)
	04800-U	32132	Laryngo: 680 (size 2-4), 690, 692 (size 3-4) Old laryngo: 634, 640, 664, 674, 684, 694 (check size)
	04900-U	32133	Ophthalmoscope: 11720, 11730, 11735, 11620, 11630
	06000-U	32134	Laryngo handles: 60813, 60814, 60713, 60815, 60803, 60804
	06500-U	32135	Macroview otoscope: 23810, 23820
	07800-U	32136	Handle: 73211, 73210, 78000, 73200

## COMPATIBLE GERMAN BULBS

GIMA BULBS	GIMA code	Compatible with the following products
<b>LARYNGOSCOPE BULBS - MADE IN GERMANY</b>		
	34324	Gima, Riester, And, Kawe, Timesco Truphatek and most of conventional laryngoscopes in the market (generally used for blades N° 00, 0, 1)
	34325	Gima, Riester, And, Kawe, Truphatek, Timesco and most of conventional laryngoscopes in the market (generally used for blades N° 2, 3, 4)
	34485	Gima, And, Kawe and most of F.O. laryngoscopes in the market. Compatible for products that use Heine Bulb # 035
<b>OTOSCOPE-OPHTHALMOSCOPE BULBS - MADE IN FRANCE-GERMANY</b>		
	31795	Heine mini 3000 otoscopes
	31796	Heine mini 3000 F.O. otoscopes
	31449	Parker otoscopes and some otoscopes of Riester, Timesco and Kawe
	31446	Parker ophthalmoscope Parker diagnostic sets
	31478	Gimalux otoscopes, Kawe and Riester mini otoscopes Compatible for products that use Heine bulb #037
	31479	Parker halogen ophthalmoscope
	31428	Gima Xenon - halogen diagnostic sets - ophthalmoscope
<b>OTO-OPHTHALMO-DERMATOSCOPE BULBS - OTHER COUNTRIES</b>		
	31188	Gima dermatoscope Compatible for products that use Heine Bulb #038
	31427	Gima Xenon - halogen diagnostic sets - otoscope

# HEINE MINI 3000<sup>®</sup> XHL AND LED<sup>HQ</sup> OTO AND OPHTHALMOSCOPE



31680  
31684  
31676  
31678

31681  
31685  
31687

31682  
31683

5 YEARS WARRANTY

31676  
31680  
31684

31678

31686  
31688

31689, 31696

## MINI 3000 F.O. XENON OTOSCOPES

Powerful pocket otoscope in a unique compact design.

- **Xenon halogen** bulbs for bright illumination and accurate colour rendering.
- **20,000 on/off switch cycles** guaranteed.
- **distal Fiber Optic (F.O.) Illumination:** Reflex-free illumination of tympanum and ear canal.
- **viewing window with 3X magnification and optimized casing surface** for razor-sharp images and minimal reflection. **Swivelling viewing window built into instrument.**
- **pneumatic testing** of the tympanum mobility by using the insufflation port and an optional connector.
- **attachment clip with integrated on/off switch.**
- **replaceable batteries:** size AA or optional rechargeable battery (31693) with mini NT table charger (31692).
- **2-piece handle and head.** Easy to maintain, flexible. Compatible with other handles.

## MINI 3000 F.O. LED<sup>HQ</sup> OTOSCOPES

All features of F.O. Xenon otoscopes with the addition of:

- **maintenance-free**, no need to ever change the LED.
- LED thermal management for a **consistent light output throughout the whole working life.**
- High-performance-LED: bright and absolutely homogeneous illumination with **excellent colour rendering** - colour temperature 4,000°K, colour rendering index >95, and >90 rendering index of the colour red.
- **twice as bright** as Xenon Halogen instruments.
- **exclusive Battery Performance Indicator**
- **exclusive fade-out function** reduces illumination intensity with battery level to let you know when to replace.
- **operation time up to 10 hours**

MINI 3000 OTOSCOPES 2.5 V				
	BLACK		BLUE	
	GIMA code	HEINE code	GIMA code	HEINE code
Standard	31680	D-001.70.210	31681	D-001.70.210
F.O. Xenon	31684	D-001.70.110	31685	D-001.70.110
F.O. LED <sup>HQ</sup>	31676	D-008.70.110	31677	D-008.70.110
MINI 3000 OTOSCOPE 2.5 V - RECHARGEABLE HANDLE**				
F.O. Xenon	31682	D-001.70.301	-	-
F.O. LED <sup>HQ</sup>	31683	D-008.70.301	-	-
MINI 3000 OTOSCOPE 2.5 V - hard case				
F.O. LED <sup>HQ</sup>	31678	D-885.20.021	-	-

Above otoscopes are supplied in a box with 5 disposable speculum Ø 4 mm and 5 Ø 2.5 mm

Supplied in hard case with 5 disposable speculum Ø 4 mm, 5 Ø 2.5 and 4 reusable speculum (Ø 2.4, 3, 4, 5 mm)

31503

Dispenser of 250 pcs.

31516

Box of 1,000 speculum

GIMA code	HEINE DISPOSABLE MINI EAR SPECULUM*	Minimum order
31501	HEINE dispenser for mini speculum - empty	-
31502	HEINE disposable Allspec <sup>®</sup> speculum Ø 2.5 mm - grey	dispenser of 250
31503	HEINE disposable Allspec <sup>®</sup> speculum Ø 4 mm - grey	dispenser of 250
31515	HEINE disposable Allspec <sup>®</sup> speculum Ø 2.5 mm - grey	box of 1000
31516	HEINE disposable Allspec <sup>®</sup> speculum Ø 4 mm - grey	box of 1000

\*Compatible with Heine Mini 2000/3000, K180, Beta 200, Beta 400

## MINI 3000 XENON OPHTHALMOSCOPES

Modern pocket ophthalmoscope with fixation star aperture. Excellent optics and best colour rendering in minimum size.

- **XHL Xenon Halogen Technology.** Concentrated bright light for perfect illumination, a brilliant image and accurate colour rendering.
- **the HEINE optics produce crisp, clear images of the whole area under examination** and minimize the reflections.
- **5 different apertures.** A full-function instrument incl. fixation star.
- **grey filter** for light sensitive patients.
- **range of lenses: 18 lenses from -20 D to +20 D.**
- **easy workflow**, because ophthalmoscopy is possible without dilation of the pupils.
- **attachment clip with integrated on/off switch.**
- **replaceable batteries.** Size AA or optional rechargeable battery (31693) with mini NT table charger (31692).

## MINI 3000 LED<sup>HQ</sup> OPHTHALMOSCOPES

All features of Xenon ophthalmoscope with the addition of:

- **maintenance-free**, no need to ever replace the LED.
- LED thermal management for a **consistent light output throughout the whole working life.**
- high-performance-LED: bright and absolutely homogeneous illumination with an **excellent colour rendering** - colour temperature 4,000°K, colour rendering index >95, and >90 rendering index of the colour red.
- **exclusive battery performance indicator**
- **exclusive fade-out function** reduces illumination intensity with battery level to let you know when to replace.
- **operation time up to 10 hours.**

MINI 3000 OPHTHALMOSCOPES 2.5 V				
	BLACK		BLUE	
	GIMA code	HEINE code	GIMA code	HEINE code
Xenon	31686	D-001.71.120	31687	D 001.71.120
LED <sup>HQ</sup>	31688	D-008.71.120	-	-
MINI 3000 OPHTHALMOSCOPES 2.5 V - RECHARGEABLE HANDLE**				
F.O. Xenon	31694	D-001.71.200	-	-
F.O. LED <sup>HQ</sup>	31695	D-008.71.200	-	-
MINI 3000 OTO-OPHTHALMO SET - hard case				
Xenon Set	31689	D-873.11.021	-	-
LED <sup>HQ</sup> Set	31696	D-886.11.021	-	-

Both set (Xenon or LED) include one F.O. otoscope head, one ophthalmoscope head, 2 handles, 4 reusable specula (Ø 2.4, 3, 4, 5 mm), 5 disposable specula Ø 4 mm and 5 Ø 2.5 mm in hard case.

NiMH rechargeable battery with bottom insert for Mini 3000 handles.

31693



31692

GIMA code	HEINE code	CHARGER AND ACCESSORIES
31691	D-000.80.101	MINI 3000 connector for pneumatic test
31692	X-001.99.484	HEINE MINI 3000 NT charger
31693	X-001.99.487 + X-001.99.488	BATTERY + BASE

\*\*Need Heine Mini 3000 NT charger (31692)

## SIGMA F.O. DIAGNOSTIC SETS

SIGMA otoscopes and ophthalmoscopes are high quality pocket diagnostic instruments designed for professional use in ENT and ophthalmology. Light weight and manufactured from impact resistant re-enforced plastic.

Supplied in deluxe rigid plastic cases or pouch (31524) with 14 disposable specula (7 with Ø 2.5 mm, 7 with Ø 4 mm).

- 31524 SIGMA F.O. OTOSCOPE 2.5 V - pouch - black
- 31523 SIGMA F.O. OTOSCOPE 2.5 V - pouch - blue
- 31525 SIGMA F.O. OTOSCOPE 2.5 V - case - black
- 31526 SIGMA F.O. LED OTOSCOPE 2.5 V - case - black
- 31518 SIGMA F.O. LED OTOSCOPE 2.5 V - case - blue

Manufactured with high quality materials and top-notch workmanship ensures excellent reliability in every examination.

Battery life with Led bulb (31526) 6 time longer than with traditional bulb

- distal fibre optic illumination with super bright Xenon/Halogen light or LED light.
- swivel type window with 3X magnification lens for sharp images and minimal reflection
- insufflation port for pneumatic testing of tympanic mobility.

Connector port (code 31532) and insufflation bulb (code 31500) should be ordered separately.

- 31527 SIGMA F.O. OPHTHALMOSCOPE 2.5 V - case - black
- 31529 SIGMA LED OPHTHALMOSCOPE 2.5 V - LED light 85,000 LUX - bulb estimated life 50,000 hours - case - black

Top quality ophthalmoscope with 5 different apertures for almost all ophthalmic examinations. High quality optics in mini format makes this instrument ideal for house calls and rounds.

- enhanced xenon/halogen super bright light
- 5 different apertures

Large spot: for normal funduscopy

Small spot: for reduced reflection with small pupils

Semi circle: for reduced reflection with small pupils

Fixation star: for determination of central or eccentric fixation, suitable for examining children

Red-free filter: for contrast-enhancement when assessing fine vascular disorders

- range of lenses from -20 D to +20 D

- 31533 SIGMA F.O. OTO-OPHTHALMOSCOPE SET 2.5 V - case with 1 handle - black
- 31528 SIGMA F.O. OTO-OPHTHALMOSCOPE DELUXE SET 2.5 V - case with 2 handles - black
- 31534 SIGMA F.O. LED OTO-OPHTHALMOSCOPE DELUXE SET 2.5 V - case with 2 handles

Oto-ophthalmo sets are supplied with oto and opthalmo head, 1 handle (31533) or 2 handles (31528, 31534) and 14 disposable speculum (7x2.5 and 7x4 mm)

- 34485 OTOSCOPE BULB - xenon - halogen 2.5 V
- 31531 OPHTHALMOSCOPE BULB - xenon - halogen 2.5 V
- 31532 PNEUMATIC CONNECTOR PORT
- 31500 INSUFFLATION BULB



31524

31527

31524,  
31525

FIBRE OPTIC  
OR F.O. LED



Colour coded 18 lenses for excellent resolution

+	1	2	3	4	6	8	10	15	20
-	1	2	3	4	6	8	10	15	20

### LED features

- colour temperature: 5,000°K
- real colours definition
- bulb estimated life 50,000 hours
- CRI > 80
- 85,000 LUX

31518

31527

31533

31528, 31534

## HEINE BETA® 200 RETINOSCOPE

- 31745 HEINE BETA 200 RETINOSCOPE - slit - 2.5 V - C-034.10.118

With ParaStop® for finding the neutralization point (US pat. 5,859,687): precise, easy selection of a parallel beam

- dustproof: maintenance free
- single control for vergence and rotation: comfortable operation
- Integrated polarisation filter: eliminates stray light and internal reflexes for a brighter pupilling reflex
- streak or spot retinoscope: simply by changing the bulb
- XHL (xenon halogen technology): bright, white light. Bright fundus reflex, easy recognition of neutralization point
- ergonomic shape: protects the examiner's orbit from stray light



5 YEARS  
WARRANTY



# E-SCOPE®: RIESTER OTO-OPHTHALMOSCOPES

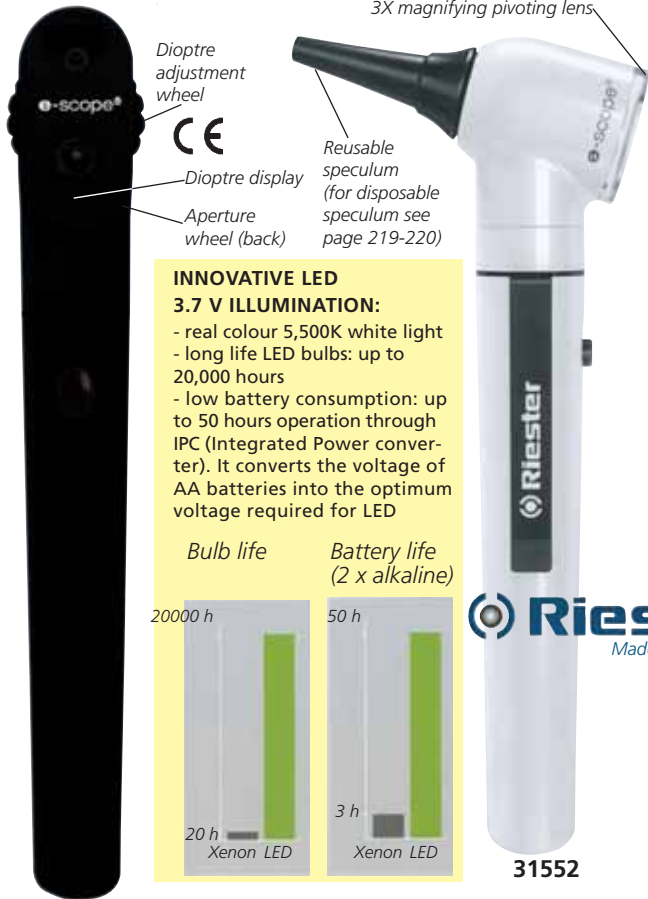

**INNOVATIVE LED**

**3.7 V ILLUMINATION:**

- real colour 5,500K white light
- long life LED bulbs: up to 20,000 hours
- low battery consumption: up to 50 hours operation through IPC (Integrated Power converter). It converts the voltage of AA batteries into the optimum voltage required for LED

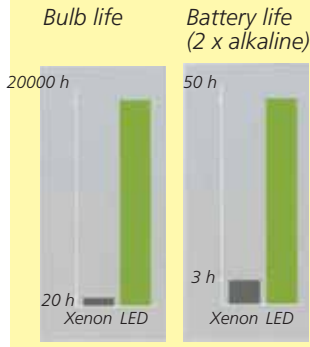

- 31550 E-SCOPE® OTOSCOPE - XENON 2.5V - black in pouch
  - 31552 E-SCOPE® F.O. OTOSCOPE - LED 3.7V - white in rigid case
- E-scope otoscope with direct Xenon illumination or F.O. LED.
- Sealing precision optics pivoting to both sides with triple magnification for superior view
  - Suitable for performance of pneumatic tests (supplied without connector and insufflator)
  - 31556 E-SCOPE® OPHTHALMOSCOPE - XENON 2.5 V - black - in rigid case
  - 31557 E-SCOPE® OPHTHALMOSCOPE - F.O. - LED 3.7 V - white - in rigid case
- E-scope ophthalmoscopes are available with Xenon or LED illumination.
- with 2.5V Xenon illumination and with innovative 3.7V LED illumination for higher-contrast and more efficient diagnosis
  - dioptre disc with 18 corrective lenses ( $\pm 1, 2, 3, 4, 6, 8, 10, 15, 20$ )
  - easy-to-use aperture wheel with six apertures (fixation star, large circle, small circle, red free filter, blue filter, semi circle)
  - high performance optics with aspherical condenser
  - spectacle protection
  - parallel optical path



- 31558 E-SCOPE® DIAGNOSTIC KIT
- Oto-ophthalmoscope set, LED 3.7V, white colour, in rigid case.
- 31560 E-SCOPE® OTOSCOPE - XENON 2.5 V BULB
  - 31561 E-SCOPE® OTOSCOPE - LED 3.7 V BULB
  - 31562 E-SCOPE® OPHTHALMOSCOPE - XENON 2.5 V BULB
  - 31563 E-SCOPE® OPHTHALMOSCOPE - LED 3.7 V BULB
  - 31817 RI-SCOPE® EAR SPECULUM Ø 2.5 mm - autoclavable
  - 31819 RI-SCOPE® EAR SPECULUM Ø 4 mm - autoclavable

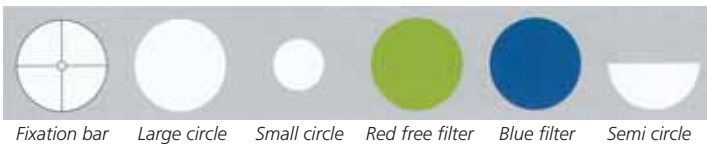

# LUXAMED AURIS LED OTOSCOPES - MADE IN GERMANY

- 31570 LUXAMED AURIS LED 2.5V OTOSCOPE - black
  - 31571 LUXAMED AURIS LED 2.5V OTOSCOPE - blue
  - 31572 LUXAMED AURIS LED 3.7V USB OTOSCOPE - black
- Innovative otoscopes that combine best handcraft production with selected materials with the most modern technology. Two-components handle (aluminium/fibre-glass reinforced) with electronic ON/OFF switch.

**Features:**

- LED-Ring illumination with 6 LEDs (concentric), no fibre optic, field of vision is not restricted, with the theoretical failure of a single LED, the functionality is not affected (patent DE202013104278U1)
- dimmer
- automatic switchoff after 3 minutes
- approx. 100,000 hours life expectancy of LEDs
- approx. 10,000 Lux intensity of illumination
- approx. 4,000 K colour temperature
- pivoting 3-fold magnifying glass with locking function
- insufflation port for pneumatic test.



Supplied with 2xAAA alkaline batteries (31570/1) or lithium-ion rechargeable battery 3.7V (31572) 20 disposable ear funnels (10x2.5 mm and 10x4.0 mm) and manual (GB, IT, DE). See page 219-220 for compatible ear speculum.



Recharger with USB plug - 3 adapters (EU, UK, US)

## HEINE K100 HALOGEN OTOSCOPE



5 YEARS WARRANTY



31720

- **31720 HEINE K 100 HALOGEN OTOSCOPE - 2.5 V - B-245.10.118** Otoscope with BETA battery 2.5 V handle with rheostat, high-impact polycarbonate housing and 3 reusable specula (Ø 3.5, 4.5, 5.5) in nylon pouch. XHL (Xenon Halogen Technology), extremely bright, white light. Acrylic viewing window with 3X magnification, insufflation port for tympanic test.
- **31771 HEINE 037 OTOSCOPE BULB 2.5 V - spare - X-001.88.037**

## HEINE K180 OTO-OPHTHALMO



31740

- **31740 HEINE K180 - F.O. OTO-OPHTHALMO SET - 2.5 V - A-279.10.118** Otoscope and ophthalmoscope K180 with BETA battery 2.5 V handle and a set of single use specula. Supplied in hard case.
- **31782 HEINE 084 OPHTHALMO BULB 2.5 V - spare - X-001.88.084**
- **31772 HEINE 077 OTOSCOPE BULB - spare - X-001.88.077**
- **31741 HEINE K180 OPHTHALMOSCOPE - 2.5 V C-182.10.118** 28 lenses from -35D to +40D supplied in pouch

## HEINE BETA 200 F.O. OTOSCOPES



31725  
31726  
31728

Large, scratch-resistant glass viewing window with 3x magnification

34449



BETA 200, BETA 400 OTOSCOPE HEAD

Distal fiber optic (F.O.) illumination with XHL xenon halogen technology  
Airtight window seal for reliable test of tympanic mobility



Handle with charge status display

31728

- **31725 HEINE BETA 200 F.O. OTOSCOPE - 2.5V - B-141.10.118** F.O. Otoscope with BETA battery 2.5V handle with rheostat, a set of single use specula, a set of reusable specula and a spare bulb. Supplied in hard case. Solid all metal construction, a quality instrument with fibre optic illumination.
- **31772 HEINE 077 OTOSCOPE BULB - spare - X-001.88.077**
- **31726 HEINE BETA 200 F.O. OTOSCOPE - 3.5V Li-ion L - B-141.29.420** Same as code 31725 but with 3.5V rechargeable handle with charging status display, Li-ion battery and charging station (34449).
- **31784 HEINE 078 OTOSCOPE BULB - X-002.88.078**

- **31728 HEINE BETA 400 LED F.O. OTOSCOPE - B-143.24.420** Exclusive 4.2X magnification. LED in HQ with continuous brightness control. All metal housing and scratch resistant glass lenses. Colour temperature: 3,500 K. Colour rendering index (CRI) >97. Exceptional depth of field, provides sharp spatial image. LED otoscope with rechargeable handle supplied with 4 reusable speculum, 5 of both All Spec disposable speculum 2.5 and 4 mm Ø in a case with NT4 table charger (34374).

## HEINE BETA 200 AND 200S OPHTHALMOSCOPES



31730



6 standard diaphragms: slit, fixation star with polar co-ordinates, cobalt blue filter, large spot, small spot, hemi spot



6 diaphragms with green filter

+ in 1 D steps 1 - 10 | 15 | 20 | 40 | D  
- in 1 D steps 1 - 10 | 15 | 20 | 25 | 35 | D

- **31730 HEINE BETA 200 HALOGEN OPHTHALMOSCOPE - 2.5 V - C-144.10.118** The unique aspherical optic system eliminates corneal and iris reflexes. The illuminated area of the retina remains fully visible even in case of small pupil (bright light). BETA 200 has 6 diaphragms with separately "green filter". It is recommended for small or expanded pupils; suitable for slit or fluorescent ophthalmoscopy as well as for fixation test. Range -35D to +40D. Supplied in hard case with replacement bulb.
- **31731 HEINE BETA 200 F.O. OPHTHALMOSCOPE - 3.5 V Li-ion - C-144.27.388** Same as 31730 but with USB rechargeable handle for mains socket and Li-ion batteries.
- **31783 HEINE 070 OPHTHALMOSCOPE BULB 3,5 V - X-002.88.070**



31730

- **31735 HEINE BETA 200S OPHTHALMOSCOPE - 2.5 V - C-261.10.118**
- **31781 HEINE 069 OPHTHALMO BULB - 2.5 V - spare - X-001.88.069**
- **31737 HEINE BETA 200S LED OPHTHALMO - 3.5 V with USB rechargeable handle - C-261.28.388** Superior aspherical optics and 74 single-diopter steps - optical system: corneal and iris reflexes are eliminated. A full view is guaranteed even with small pupils.
- XHL (Xenon Halogen Technology) or LED: bright, white light.
- recessed, multi-coated viewing window: avoids stray light.
- optics mounted on precision metal chassis.
- ergonomic shape: instrument fits the orbita comfortably in any position.
- 7 apertures with separate red-free filter:
- lens range: perfect focus even with high refractive errors.
- exact colour rendering



Cobalt blue filter, fixation star with polar co-ordinates, large spot, small spot, pinhole, slit, hemisport



With red-free filter: Cobalt blue filter, fixation star with polar coordinates, large spot, small spot, pinhole, slit, hemisport



74 single diopters steps + in 1 D steps: +1 through +38 D - in 1 D steps: -1 through -36 D

## VISIO 2000 F.O., XENON OTO, OPHTHALMO, ENT SETS - 3.5 V

Professional diagnostic sets with fiber optic illumination system, Xenon light 3.5 V, rheostat to adjust the intensity of light. Powered by rechargeable Li-ion batteries.

All products are made of impact resistant re-inforced plastic and durable easy locking system for hospital long term use. Supplied in deluxe case, should be used with charging station 31542 and Li-ion rechargeable battery (31541). Only plug-in set (31537) as direct AC connection and need battery 31547.

- 31535 VISIO 2000 F.O. XENON OTOSCOPE - 3.5 V
- 31536 VISIO 2000 F.O. XENON OPHTHALMOSCOPE - 3.5 V
- 31537 VISIO 2000 F.O. XENON OTO-OPHTHALMOSCOPE PLUG-IN SET - 3.5 V - 2 pin plug
- 31538 VISIO 2000 F.O. XENON OTO-OPHTHALMOSCOPE - 3.5 V
- 31539 VISIO 2000 F.O. XENON DIAGNOSTIC SET - 3.5 V
- 31428 OPHTHALMOSCOPE BULB - spare
- 31544 OTOSCOPE BULB - spare
- 31541 LI-ION RECHARGEABLE BATTERY
- 31547 LI-ION RECHARGEABLE BATTERY 3.5 V PLUG-IN HANDLE for 31537

- 31542 ZOOM CHARGING STATION Supplied with EU 2 pin, UK and US plug

Swivel type window with 3X magnification for sharp images and minimal reflection



Distal F.O. illumination with super bright xenon light

Durable easy locking system

Rheostat

6 apertures to select from:

- Micro spot aperture
- Small aperture
- Large aperture
- Fixation aperture
- Slit
- Red-free filter

Enhanced Xenon super bright light

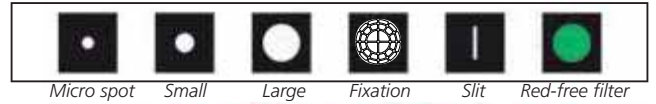

0	1	2	3	4	5	6	7	8	9	10	12	15	20	40
	1	2	3	4	5	6	7	8	9	10	15	20	25	

Colour coded 28 lenses for perfect examination (GREEN for +, RED for -)



31542



31535

**F.O. Xenon otoscope set 3.5 V**  
F.O. otoscope head, battery handle with bayonet lock, 1 set of 5 reusable eartips (2.5, 3.5, 4.5, 5.5 & 9.0 mm), tube of 14 disposable eartips (2.5 & 4.0 mm), spare bulb, in a rigid case.



31537

**F.O. Xenon oto/ophthalmo plug-in set 3.5 V**  
F.O. otoscope head, F.O. ophthalmoscope head, one battery handle with bayonet lock and plug-in, 1 set of 5 reusable eartips (2.5, 3.5, 4.5, 5.5 & 9.0 mm), tube of 14 disposable eartips (2.5 & 4.0 mm), spare oto and ophthalmo bulbs, rechargeable Li-ion battery in a rigid case.



Plug-in handle



31538

**F.O. Xenon oto/ophthalmo set 3.5 V**  
F.O. otoscope head, F.O. ophthalmoscope head, two battery handles with bayonet lock, nasal illuminator with F.O. light, 1 set of 5 reusable eartips (2.5, 3.5, 4.5, 5.5 & 9.0 mm), tube of 14 disposable eartips (2.5 & 4.0 mm), spare oto and ophthalmo bulbs in a rigid case.



31539

**F.O. Xenon ENT diagnostic set 3.5 V**  
F.O. otoscope head, F.O. ophthalmoscope head, battery handle with bayonet lock, nasal illuminator with F.O. light, curved illuminator with bulb, plain mirror 20.0 mm, plastic tongue depressor, 1 set of 5 reusable eartips (2.5, 3.5, 4.5, 5.5 & 9.0 mm) tube of 14 disposable eartips (2.5 & 4.0 mm), spare oto and ophthalmo bulbs, in a rigid case.

## GIMA VISIO 2000 WALL DIAGNOSTIC STATION - 3.5 V

- 31545 GIMA WALL DIAGNOSTIC STATION - 3.5 V
- Perfect solution for everyday clinical and hospital life. The unit has a centralized electrical supply, eliminating the need for conventional or rechargeable batteries. Wall station is equipped with two handles one with Visio 2000 otoscope Xenon light head and one with Visio 2000 ophthalmoscope Xenon light head.
- Main features:
- automatic ON/OFF switching of the handles, the instrument turns off automatically once the handle is placed in the cradle
  - non-slip ergonomic handle design
  - handle with a brightness control mechanism for light adjustment
  - spiral cable enables working at 3 metres
- Power: 115-230 V, 50-60 Hz. Disposable ear speculum see page 220



31545

# RI-FORMER® THE MODULAR DIAGNOSTIC STATION 3.5V



## RI-FORMER MODULAR DIAGNOSTIC STATION

The modular diagnostic station can be individually combined according to requirements and the room situation, it is variably extendable to the right and the left.

The basic ri-former® module is available with one handle and can be supplemented with up to 4 further handle modules.

- 3.5V Xenon or LED illumination creates lighting conditions similar to daylight

- optimum electronic efficiency using an adjustable dimmer  
 - constant output voltage independent from the mains supply prolongs the service life of the lamps and guarantees optimum light intensity

- automatic switching on/off of handles when removing or replacing them in the handle unit saves energy and increases the service life of the lamps

- non-slip, ergonomically designed handles with rheostat: infinitely variable regulation of brightness as well as manual switching on/off possible on the handle

- spiral cord expandable up to 3 m

- developed and manufactured in Germany.



GIMA code	MODULAR DIAGNOSTIC STATION - XENON
31800	Ri-Former Diagnostic station 3.5-230V* 50/60 Hz-standard (include 2 handle oto and ophthalmo head, ear specula dispenser, clock)
31805	Ri-Former Diagnostic station 3.5-230V* 50/60 Hz-large (include 31800 + sphygmomanometer) *available on request 120V - 50/60 Hz
MODULAR DIAGNOSTIC STATION - LED	
31801	Ri-Former Diagnostic station 3.5-230V* 50/60 Hz-standard (include 2 handle, LED oto and ophthalmo head, ear specula dispenser, clock)
31806	Ri-Former Diagnostic station 3.5-230V* 50/60 Hz-large (include 31801 + sphygmomanometer) *available on request 120V - 50/60 Hz
RI-FORMER MODULES AND HEADS	
31809	Basic diagnostic station 1 handle 3.5 - 230V* 50/60 Hz
31810	Extension module 1 handle
31811	Ri-scope L2 otoscope head - Led 3.5V
31812	Ri-scope L1 otoscope head - Xenon 3.5V
31813	Ri-scope L1 ophthalmoscope head - Xenon 3.5V
31814	Ri-scope retinoscope head - Xenon 3.5V
31815	Ri-scope dermatoscope head - Led 3.5V
31817	Ri-scope L1, L2 ear speculum Ø 2.5 mm** - autoclavable 134°C
31819	Ri-scope L1, L2 ear speculum Ø 4 mm** - autoclavable 134°C
31820	Ri-spec ear specula dispenser - specula not included
31822	Sphygmomanometer with basket
31823	Ri-thermo N infrared thermometer with 40 covers
31824	Probe cover for 31823 - box of 100 - spare
31825	Xenon L1 otoscope bulb 3.5V - spare
31826	Xenon ophthalmoscope L1, L2, L3 bulb 3.5V - spare

\*Available on request 120V - 50/60 Hz

\*\*box of 10



## RI-SCOPE® L: LED + Li-ion BATTERIES

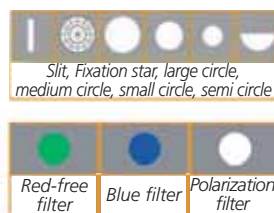

31830

**LED illumination: bright, white light with a nearly unlimited lifetime!**  
 With its monochromatic white light (4,000° Kelvin) the lamp in the ri-scope®L provides cold light and true-colour. CRI > 90. Lamps with LED technology have a lifetime of at least 10,000 hours (compared to 20-30 hours with halogen and Xenon lamps) and are extremely energy-efficient.

**Li-ion batteries - greatest power in the smallest space!**

Considerably higher charging capacity, longer lifetime, light-weight, these are the big advantages of Li-ions batteries; wich provide sustained high performance for up to 1200 charging cycles. LEDs powered by lithium batteries can burn for up to 50 hours.

• 31830 RI-SCOPE L2 LED OTOSCOPE - 3,5 V

The newest generation ri-scope®L otoscopes with optical glass and reduced reflection combines excellent optical properties and unparalleled performance with the reliability and efficiency of LED/lithium-ion technology.

- optimal beaming and transmission of the light.

- bi-directional swivelling, sealing optical glass 3X

- Suitable for pneumatic test (supplied without ball).

- C handle runs Li-ion batteries, not included.

Supplied in deluxe hard case with one spare lamp, 4 reusable ear specula and 3 disposable ear specula.

Spare ear speculum: use above 31817-31819 (autoclavable) or 31485 to 31499 (disposable) page 220.

• 31832 RI-SCOPE L2 XENON OPHTHALMOSCOPE - 3,5 V

The enhanced basic model with separately engageable red-free, blue and polarization filters for each aperture.

- Diopter wheel with 29 corrective lenses Plus 1-10, 12, 15, 20, 40 Minus 1-10, 15, 20, 25, 30, 35

- Easy-to-operate aperture hand-wheel with semi-circle, small/medium/large circle, fixation star, and slit

- Includes filter wheel engageable for all apertures with symbol display, red-free filter, blue filter and polarization filter

• 31826 XENON L1/L2/L3 OPHTHALMOSCOPE BULB 3,5 V - spare

• 31834 RI-SCOPE L2 LED OTOSCOPE + L2 XENON OPHTHALMOSCOPE 3.5 V - C handle

• 31841 "C" SIZE Li-ion BATTERY

• 31840 RI-CHARGER L 230 V



Table recharge station (with wall holder) recharge 2 "C" handles with Li-ion batteries.

31840

# GIMA OTOSCOPES: PARKER LINE

VETERINARY OTOSCOPES AND SETS SEE PAGE 370



31442

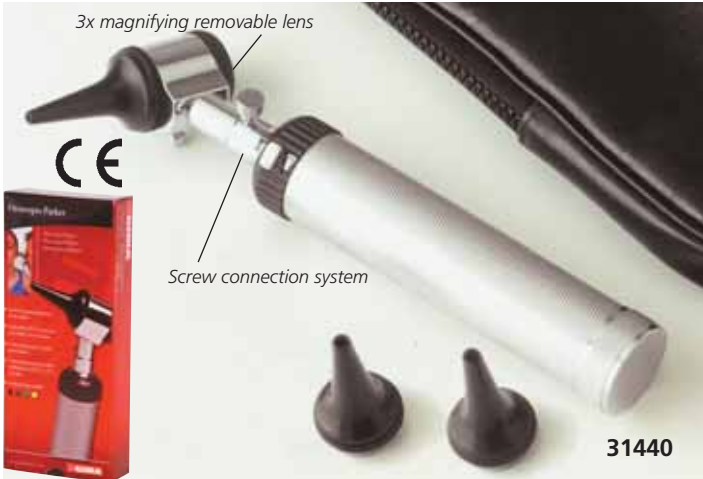

31440



31436

31437

31435

BAYONET CONNECTION SYSTEM

## PARKER OTOSCOPES

- reliable and indestructible high quality instrument
- suitable for everyday ear nose and throat examinations
- easily adjustable 2.5 V vacuum light (made in Germany)
- quality 3 times magnifying lens
- available with Plug in and snap (bayonet locking) or knurled screw type otoscope heads
- ideal for pneumatic tympanic membrane tests, can also be used for rhinoscopic examinations
- supplied with 3 autoclavable ear funnels in a colour coordinated zip bag.
- All latex free.
- require 2xC batteries (not included) 31542
- 31441 also works with rechargeable battery



GIMA code	PARKER OTOSCOPES	Connection system	Ear Funnels
31435	Parker colour - green	Bayonet	Ø 2.5, 3.5, 4.5 mm
31436	Parker colour - blue	Bayonet	Ø 2.5, 3.5, 4.5 mm
31437	Parker colour - yellow	Bayonet	Ø 2.5, 3.5, 4.5 mm
31440	Parker - black	Screw	Ø 2.5, 3.5, 4.5 mm
31441	Parker with rechargeable handle	Bayonet	Ø 2.5, 3.5, 4.5 mm
31442	Parker veterinary - black	Screw	Ø 4, 5, 7 mm
31449	Spare bulb 2.5 V for Parker otoscopes 31435-6-7,31440-1-2		
31542	Charging station for 31441		
34467	Rechargeable Li-ion battery 2.5 V / 2,200 mAh		

# PARKER DIAGNOSTIC SETS

- **31471 PARKER DIAGNOSTIC SET**  
Lightweight, semi rigid nylon case with one Parker otoscope 2.5 V with rechargeable handle, 3 autoclavable ear speculum (Ø 2.5, 3.5 and 4.5 mm), 2 laryngeal mirrors (size 3 and 4), bent arm throat lamp, tongue spatula, adjustable nasal speculum.
- **31473 PARKER LARGE SET WITH OPHTHALMO**  
Same as code 31471 with an ophthalmoscope head, support for single use tongue depressors and 2 tubes of single use specula.
- **31446 VACUUM BULB FOR OPHTHALMOSCOPE**
- **31449 VACUUM BULB FOR OTOSCOPE**
- **32203 "C" ALKALINE BATTERIES - blister of 2 pcs** 31471
- **34467 RECHARGEABLE LI-ION BATTERY 2.5 V - needs 31542**

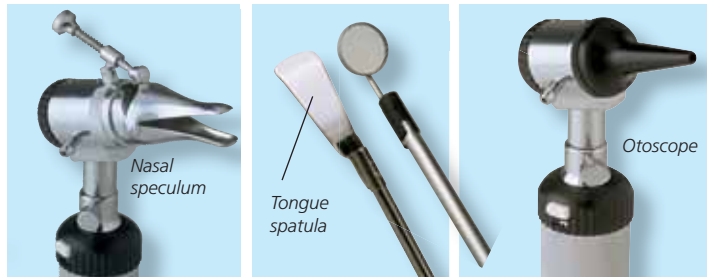

Nasal speculum

Tongue spatula

Otoscope



Ophthalmoscope head

CE

Tongue spatulae

Wooden tongue depressor holder

2 tubes of single use specula

Otoscope

31473

Laryngeal mirrors

Nasal specula  
Reusable Ear tips

Bent arm throat lamp/Laryngeal mirror holder

Rechargeable handle for use with 2xC batteries or rechargeable battery

# LED OTOSCOPE - PEN LIGHT

- **31300 COMBI SET**  
Dual function instrument features convertable diagnostic pen light and mini-otoscope with 3 different sizes of funnels or specula.  
White Led light. Packed in a gift box.  
Pupil gauge and dual slide rule printed on the penlight.  
Supplied with batteries (2xAAA).
- **32200 "AAA" ALKALINE BATTERIES - blister of 4 pcs**
- **31345 REUSABLE EAR SPECULUM 2.0 mm - bag of 25**
- **31346 REUSABLE EAR SPECULUM 4.0 mm - bag of 25**



CE

31300

## XENON-HALOGEN OTO AND OPHTHALMOSCOPE SET



Rechargeable handle for use with 2xC batteries or rechargeable battery (34467)

31475

- **31475 XENON-HALOGEN PARKER OTOSCOPE**  
Same as PARKER Otoloscope code 31440 but with halogen 2.5V bulb, and bayonet connection system. Supplied with 3 autoclavable ear funnels in a soft bag. Requires 2xC batteries (not included) or rechargeable battery.
- **31474 HALOGEN OPERATIVE PARKER OTOSCOPE**  
Same as 31475 but with operative head.
- **31476 HALOGEN PARKER OPHTHALMOSCOPE**  
2.5V halogen light for true tissue colour and consistent, long lasting illumination 24 colour coded lenses -25 to +40 dioptres for excellent resolution (green for +, red for -). Rubber eye brow rest to prevent scratching of eye-glasses. Illumination lens dial for clear identification of dioptre setting.
- **31477 HALOGEN OTO-OPHTHALMOSCOPE PARKER SET**  
Diagnostic set including one handle, one halogen otoscope head and one halogen ophthalmoscope head, all in a plastic case.
- **31478 XENON-HALOGEN BULB FOR OTOSCOPE 2.5V**
- **31479 XENON-HALOGEN BULB FOR OPHTHALMOSCOPE 2.5V**
- **34467 RECHARGEABLE LI-ION BATTERY 2.5 V / 2,200 mAh**
- **31542 CHARGING STATION**
- **32203 "C" ALKALINE BATTERIES - blister of 2 pcs**



Supplied in a semi-rigid nylon bag with multilingual box and manual (GB, FR, IT, ES, PT, DE, GR, Arabic)

31476



31474



31477

All products are latex free.



+	1, 2, 3, 4, 5, 6, 8, 10, 12, 15, 20, 40
-	1, 2, 3, 4, 5, 6, 8, 10, 15, 20, 25

## XENON-HALOGEN DIAGNOSTIC SETS IN RIGID CASES

- **31480 XENON-HALOGEN DIAGNOSTIC SET - 3.5 V**
- **31482 XENON-HALOGEN OPERATIVE DIAGNOSTIC SET - 3.5 V**  
Both xenon-halogen sets are supplied in plastic rigid case containing: one rechargeable handle, one otoscope head (operative for code 31482) one ophthalmoscope head, 3 autoclavable speculum Ø 2.5, 3.5, 4.5 mm, two laryngeal mirrors (size 3 and 4), adjustable nasal speculum, bent throat lamp, tongue spatula. Should be used with 31541 + 31542.
- **31427 XENON-HALOGEN OTOSCOPE BULB 3.5V**
- **31428 XENON-HALOGEN OPHTHALMO BULB 3.5V**
- **31542 CHARGING STATION - 100-240 V - 50/60 Hz**  
See details at page 327.
- **31541 RE-CHARGEABLE LI-ION BATTERY 3.5V\***  
\*For handles sold after may 2013



Operative otoscope head



31542



31480

## FIBRE OPTIC XENON-HALOGEN OTOSCOPES

- **31520 GIMALUX F.O. OTOSCOPE - black**
  - **31521 GIMALUX F.O. OTOSCOPE - blue**
  - **31522 GIMALUX F.O. OTOSCOPE - green**
- High professional plastic otoscopes with extra bright halogen light provided by fibre optic system. Quality 3 times magnifying movable lens. Output for pneumatic membrane test. Supplied with 14 single use mini speculums (7 Ø 2.5 and 7 Ø 4 mm) in a colour coordinated nylon bag. For mini ear-speculum see at page 220. All latex free.
- **34485 XENON-HALOGEN BULB 2.5V**  
Old model with chrome insufflation adapter need below bulb
  - **31478 XENON-HALOGEN BULB 2.5V for old models**

Insufflation adapter

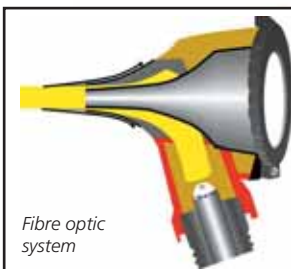

Fibre optic system



31521

31522

31520





## DISPOSABLE EAR-SPECULUM FOR "TRADITIONAL" OTOSCOPES

GIMA code	DISPOSABLE EAR - SPECULUM FOR OTOSCOPES OF DIFFERENT BRANDS	Colour	To be used with	Minimum order
31313	Disposable ear-speculum Ø 2.5 mm	■	} Gowllands (with connector 31316) } Riester (some models) } Gowllands	box of 200 pcs. box of 200 pcs.
31315	Disposable ear-speculum Ø 4 mm	■		
31316	Connector for 31313-31315	■		
31504	Disposable ear-speculum Ø 2.5 mm	■	} Heine Beta 100, K100 and Eurolight, } Kawe C10, C30, Combilight C10	box of 1000 pcs. (20 pack of 50) box of 1000 pcs. (20 pack of 50)
31505	Disposable ear-speculum Ø 4 mm	■		
31506	Disposable ear-speculum Ø 2.5 mm	■	} Riester: Ri-star	dispenser of 250 pcs. dispenser of 250 pcs.
31507	Disposable ear-speculum Ø 4 mm	■		
31508	Disposable ear-speculum Ø 2.5 mm	■	} Welch Allyn: Pocket-pro; Pocket scope } Series 200, 250	dispenser of 250 pcs. dispenser of 250 pcs.
31509	Disposable ear-speculum Ø 4 mm	■		

 <p>Suitable for <b>RIESTER GOWLLANDS</b></p> <p>31316 31313 31315</p>	 <p>Suitable for <b>HEINE</b></p> <p>31504-31505</p>	 <p>Suitable for <b>RIESTER</b></p> <p>31506-31507</p>	 <p>Suitable for <b>WELCH-ALLYN</b></p> <p>31508-31509</p>
--	---	--	---

## WELCH-ALLYN KLEENSPEC DISPOSABLE EAR SPECULUM



GIMA code	WELCH-ALLYN KLEENSPEC Disposable ear-speculum	Colour	To be used with	Minimum order	
72570	KleenSpec ear-speculum Ø 3 mm	■	} Welch-Allyn 20100, 20200 } 20202, 21600, 21700	box of 100 (4 packs of 25 pcs.) box of 100 (4 packs of 25 pcs.)	
72571	KleenSpec ear-speculum Ø 4 mm	■			
32105	KleenSpec ear-speculum Ø 2.75 mm	■	} Welch-Allyn, Macroview } Riester Ri-scope L2, L3	box of 850 box of 850	
32106	KleenSpec ear-speculum Ø 4.25 mm	■			

## ALKALINE, LITHIUM AND ZINC-AIR "ACOUSTIC" BATTERIES

						
32200	32201	32203	32202	32211	32220	32221
FOR GENERAL USE APPLICATIONS				FOR ELECTRONIC	FOR ACOUSTIC	

GIMA code	VARTA ALKALINE HIGH ENERGY BATTERIES	Type	Blister	GIMA code	VARTA LITHIUM BATTERIES - BUTTON	Blister
32200	Varta ministilo H.E. - alkaline	AAA	4 pcs.	32210	Varta 2016 - lithium button	1 pc.
32201	Varta stilo H.E. - alkaline	AA	4 pcs.	32211	Varta 2025 - lithium button	1 pc.
32203	Varta half torch H.E. - alkaline	C	2 pcs.	32212	Varta 2032 - lithium button	1 pc.
32204	Varta torch H.E. - alkaline	D	2 pcs.			
32205	Varta 9V H.E. - alkaline	9V	1 pc.			
GIMA code	VARTA ENERGY ALKALINE BATTERIES - BULK	Type	Box	GIMA code	RAYOVAC ZINC-AIR "ACOUSTIC BATTERIES" - mercury free	Blister
32202	Varta Energy Stilo - alkaline	AA	24 pcs.	32220	Rayovac 675 - zinc air - acoustic	6 pcs.
				32221	Rayovac 13 - zinc air - acoustic	6 pcs.
				32222	Rayovac 312 - zinc air - acoustic	6 pcs.
				32223	Rayovac 10 - zinc air - acoustic	6 pcs.

## RECHARGEABLE BATTERIES AND CHARGERS

GIMA code	VARTA POWER PLAY RECHARGEABLE BATTERIES	Type	Blister	32236				
32235	Varta ministilo - 1000 mAh	AAA	2 pcs.				32241	
32236	Varta stilo - 2400 mAh	AA	4 pcs.					
GIMA code	CHARGERS FOR ANY BRAND	Power supply	Sizes mm	Weight g	To be used with:	Recharging time	Supplied with:	12V+USB adaptor
32241	Universal charger	100 - 240 V	172x109x53	403	AAA, AA, C, D, 9C	5 h	-	no
32242	LCD charger	110 - 240 V	120x230x75	359	AAA, AA	2-4 h	4AA	yes

# GIMA DISPOSABLE EAR-SPECULUM FOR MINI OTOSCOPES OF DIFFERENT BRANDS

GIMA code	GIMA DISPOSABLE SPECULUM FOR MINI OTOSCOPES - LATEX FREE	Colour	Compatibility		Minimum order
			Direct fit	Fit with connector 31493	
31485	Disposable Mini ear-speculum Ø 2.5 mm - grey	Grey	Gima 31520-22, 31525-26, 31535, 31545 Heine mini 2000, 3000, K180/Beta 200 Riester Ri-Mini, Ri-scope L1-L2, E-scope, Pen-scope Kawe (Picolight, Combilight F030, Eurolight F030) Holtex Colson Luxamed	Gima: 31435-37, 31440-42, 31471, 31473, 31475, 31477, 31480, 31493	dispenser of 250 dispenser of 250 dispenser of 250 pack of 100 box of 1,000 pack of 100 pack of 100 pack of 100 -
31486	Disposable Mini ear-speculum Ø 4 mm - grey	Grey			
31487	Disposable Mini ear-speculum Ø 2.5 mm - black	Black			
31488	Disposable Mini ear-speculum Ø 4 mm - black	Black			
31491	Disposable Mini ear-speculum Ø 2.5 mm - black	Black			
31492	Disposable Mini ear-speculum Ø 4 mm - black	Black			
31495	Disposable Mini ear-speculum mixed colours and Ø	Mixed			
31496	Disposable Mini ear-speculum Ø 2.5 mm - blue	Blue			
31497	Disposable Mini ear-speculum Ø 4 mm - blue	Blue			
31498	Disposable Mini ear-speculum Ø 2.5 mm - green	Green			
31499	Disposable Mini ear-speculum Ø 4 mm - green	Green			

GIMA code	CONNECTORS FOR MINI EAR SPECULUM	Colour	To be used with GIMA codes
31493	Connector to GIMA Parker otoscope for Mini ear-speculum	Green	31435, 31436, 31437, 31440, 31441, 31442, 31471, 31473, 31475, 31477
31494	ALLIGATOR connector (supplied with 100 ear speculum)	Green	31435, 31436, 31437, 31440, 31441, 31442, 31471, 31473, 31475, 31477



## HEINE DISPOSABLE MINI EAR-SPECULUM



GIMA code	HEINE DISPOSABLE MINI EAR SPECULUM*	Minimum order
31501	HEINE dispenser for mini speculum - empty	-
31502	HEINE disposable Allspec® speculum Ø 2.5 mm - grey	dispenser of 250
31503	HEINE disposable Allspec® speculum Ø 4 mm - grey	dispenser of 250
31515	HEINE disposable Allspec® speculum Ø 2.5 mm - grey	box of 1,000
31516	HEINE disposable Allspec® speculum Ø 4 mm - grey	box of 1,000

\*Compatible with Heine Mini 2000/3000 K180, Beta 200

## RIESTER AUTOCLAVABLE MINI EAR-SPECULUM

**Riester** Compatible with Ri-scope L1, L2, E-scope, Ri-mini, Pen-scope

GIMA code	AUTOCLAVABLE MINI EAR SPECULUM	Colour	Minimum order
31817	Riester ear speculum Ø 2,5 mm - black	Black	box of 10 pcs.
31819	Riester ear speculum Ø 4 mm - black	Black	box of 10 pcs.

# REUSABLE CANNULAS AND EAR SPECULUM

GIMA code	AUTOCLAVABLE SPECULUM FOR PARKER OTOSCOPES - LATEX FREE	Colour	To be used with GIMA code	Also compatible with	Minimum order
31447	Kit 3 autoclavable veterinary speculum Ø 4, 5, 7 mm	Black	31435-37, 31440-42, 31471, 31473, 31475, 31477, 31480	Heine, Kawe, Riester	One kit
31448	Kit 3 autoclavable speculum Ø 2.5, 3.5, 4.5 mm	Black	31435-37, 31440-42, 31471, 31473, 31475, 31477, 31480	Heine, Kawe, Riester	One kit
31451	Kit of 5 autoclavable speculum Ø 2.5, 3.5, 4.5, 5.5, 9 mm	Black	31435-37, 31440-42, 31471, 31473, 31475, 31477, 31480	Heine, Kawe, Riester	One kit
31453	Kit of 3 metal cannulas (Ø 4, 5, 6 mm) + 2 slotted metal specula (Ø 7.5 and 9.4 mm)	Black	31435-37, 31440-42, 31471, 31473, 31475, 31477, 31480	Heine, Kawe, Riester	One kit
31500	Pneumatic bulb for Otoscopes	Black	31435/36/37/40/42/71/73/75/77-31520/21/22, 31535	Heine, Kawe, Riester	-

Gima autoclavable ear speculum 31447, 31448, 31451 features:  
 - made from resilient thermoplastic material  
 - smooth and shiny surface ensure easy cleaning  
 - Metallic bayonet lock for positive fit to otoscope  
 - autoclavable at 134°C

2 slotted models with 60 mm opening and round edges, ideal for instrumentation, atraumatic insertion

Matt inner surface to reduce risk of reflection

# OTOSCILLO® ELECTRICAL IRRIGATION DEVICE

- 25815 OTOSCILLO®
  - 25800 PROFESSIONAL OTOSCILLO®
- Otosillo® is designed for automated ear rinsing both in hospitals and during private consultations. Innovative, compact, efficient and rapid, the Otosillo® combines the most sophisticated operating qualities with the best security guarantees, all in a single device.



**Anywhere, anytime**

Otosillo® is an electrical irrigation for simplified rinsing of the ear canal. The pulsating stream system makes it easier to remove cerumen, even at low pressure control, Otosillo® is particularly adapted to the treatment of sensitive ear canals. It looks less alarming and it is easier to use, with greater accuracy and security, than the alternatives. The water basin is removable to allow easy filling and emptying. Can be mounted on a wall (only 25815) or a cupboard. Operating power: 220V - 50/60 Hz.

**Professional Otosillo®** same as 25815, but supplied with automatic back stop behind disposable nozzle for preventing cross-infections.

- 25816 SPARE SET (2 reusable tips + disk) for 25815
- 25817 SPARE HANDLE + TUBE
- 25814 DISPOSABLE TIPS SET (100 disposable tips, 1 disk, connector) for 25800 and 25815
- 25818 DISPOSABLE TIPS for 25800 - box of 100

Water temperature control system



Otosillo is supplied with applicator set (1 long nozzle, 1 short nozzle, 1 splash guard) carrying handle and temperature test card

# GLASS-METAL, ALL-METAL AND SINGLE-USE EAR SYRINGES



**GLASS-METAL JANET RECORD SYRINGES**

High quality, reliable and accurate glass-metal syringes. Janet Record come complete with 2 cannulas, one conical, one oval. Individually packed in cardboard box. Made in Germany.

GIMA code	GLASS-METAL SYRINGES COMPLETE WITH 2 CANNULAS
25801	Janet Record 50 cc - 13 x Ø 3.5 cm
25802	Janet Record 100 cc - 14 x Ø 4.7 cm
25803	Janet Record 200 cc
25804	Spare cannula for Janet Record (conical shape)
25805	Spare cannula for Janet Record (olive shape)

MADE IN GERMANY



**ALL-METAL SCHIMMELBUSCH SYRINGES**

High quality, reliable and accurate syringes. Schimmelbusch come complete with 3 cannulas and ear bowl. Individually packed in cardboard box. Made in Germany.

GIMA code	ALL-METAL SYRINGES COMPLETE WITH 3 CANNULAS AND EAR BOWL
25806	Schimmelbusch 50 cc
25807	Schimmelbusch 100 cc
25808	Schimmelbusch 200 cc
25809	Spare cannula for Schimmelbusch (conical shape)
25812	Spare cannula for Schimmelbusch (olive shape) small
25813	Spare cannula for Schimmelbusch (olive shape) large

# HIGH CAPACITY POLYPROPYLENE SYRINGES



**HIGH CAPACITY POLYPROPYLENE SYRINGES - sterile**

Sterile, single use, latex free syringes for ear and other purposes. Box in GB, FR, IT, ES, DE, PT, GR, RO, RU, YU, SA. Medical Device class IIa.

GIMA code	HIGH CAPACITY, POLYPROPYLENE SYRINGES STERILE - CATHETER CONE	Minimum order
23820	Syringe 60 ml	box of 20
23821	Syringe 100 ml	box of 25

# OTOCLEAR® EAR IRRIGATION SYSTEM

Kit includes:  
1 spray wash bottle  
20 otoclear tips  
1 ear basin



25858



- 25858 OTOCLEAR EAR SPRAY WASH  
- manual, intermittent lavage  
- delivers greater volume compared to syringes or other manual devices  
- efficient design allows for two handed procedure

- 25861 OTOCLEAR EAR IRRIGATION TIPS  
single use - box of 40 - spare  
Flared design protects against over-insertion. The tip directs three streams of water towards the walls of the ear canal, away from the tympanic membrane, creating a turbulent lavage that effectively dislodges the cerumen. The exit portal controls backsplash and directs drainage into a basin.
- 25862 EAR IRRIGATION BASINS - box of 3 - spare



Thermometer for water temperature



Improved patient comfort thanks to the soft "gentle touch" design



Patented 3-stream action

# LOOP-SPOON EAR CURETTES

- 31470 GIMA EAR CURETTES - box of 10 pcs  
Double function currettes: one side spoon, one side loop. Each currette is individually packed in a single pouch.

31470



# BIONIX EAR CURETTES

**FLEXLOOP:**  
For normal curettage  
Most flexible of all  
Least traumatic  
Rounded tips for comfort  
4 mm wide tip



**MICROLOOP:**  
For compact cerumen  
More rigid construction  
Tip can be angled for added strength  
Rounded tip for comfort  
3 mm wide tip



**INFANTSCOOP:**  
For the smallest ears  
For when a small scoop works better  
Can be used through an otoscope • Flexible  
2 mm wide tip



**CERASPOON:**  
For viscous cerumen  
For extensive cerumen buildup  
For when a large scoop works better  
4 mm wide tip



The complete cerumen management system

- 31462 FLEXLOOP - white - box of 50 pcs
- 31464 INFANTSCOOP - light blue - box of 50 pcs
- 31460 MICROLOOP - green - box of 50 pcs
- 31467 CERASPOON - yellow - box of 50 pcs



Our four styles of currettes give you the most effective, economical and safe way to remove cerumen - whatever the size of ear or consistency of cerumen.

**Patient comfort:** Metal currettes are cold, hard and sharp. BIONIX ear currettes with rounded plastic tips reduce trauma and risk of laceration. Latex free.

**Effectiveness:** Ear currettes can duplicate the effectiveness of metal currettes in almost any situation and their polypropylene composition makes them virtually unbreakable.

**Disposability:** Ear currettes don't require expensive and time-consuming sterilization and eliminate the risk of cross-contamination.



# LIGHTED EAR CURETTES

- 31450 KIT MIXED LIGHTED CURETTES  
Kit is composed by 50 lighted currettes (8 FlexLoop and 7 of each of below other 6 tip styles) + LED illuminator + magnification lens



 <b>MicroLoop®</b> 3 mm diameter loop	 <b>FlexLoop®</b> 4 mm diameter tip
 <b>InfantScoop®</b> 2 mm diameter tip	 <b>AngleLoop®</b> Angled 4 mm diameter loop
 <b>WaveCurette™</b> new wave like 2.5 mm tip	 <b>VersaLoop®</b> 3 mm wide tip
 <b>CeraSpoon®</b> 4 mm wide tip	



Scan QR code with your web enabled camera phone to see Video



31458

Lighted forceps for foreign body removal with LED illuminator

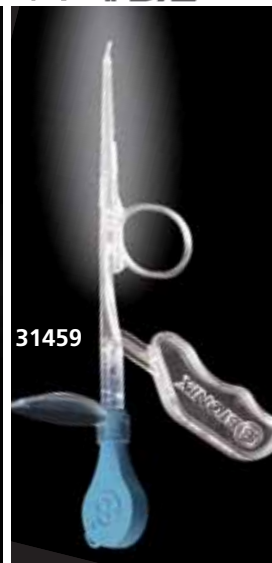

31459

Lighted ear currette 3 mm tip with LED illuminator

- 31461 KIT MICROLOOP
- 31463 KIT FLEXLOOP
- 31465 KIT INFANTSCOOP
- 31466 KIT ANGLELOOP
- 31468 KIT VERSALOOP

All kits are composed by 50 lighted currettes + LED light source + magnification lens

- 31458 LIGHTED FORCEPS - box of 10 + magnification lens + LED illuminator
- 31459 LIGHTED ARTICULATING CURETTES - box of 25 + magnification lens + LED light source

Ear currette tip has a 90° range of motion. It articulates to assist in removal of cerumen from the ear canal



## WOOD TONGUE DEPRESSORS



**PERSONALIZATION**  
minimum: 100,000 pieces  
ask for leaflet



Quality tongue depressors manufactured with selected high quality smooth birch wood. Edges accurately finished. 150x18x1.6 mm. Individually packed in a paper envelope and sterilized.

Wooden medical tongue depressors made of quality birch wood. Edges accurately finished. Size: 150x18x1.6 mm Made in PRC.

GIMA code	WOOD TONGUE DEPRESSOR - STERILE
25511	Tongue depressor - box of 50
25512	Tongue depressor - box of 2,000 (40 boxes of 50 pcs)

GIMA code	WOOD TONGUE DEPRESSORS NON-STERILE
25509	Tongue depressor - box of 100
25510	Tongue depressor - box of 5,000 (50 boxes of 100 pcs)

## PLASTIC TONGUE DEPRESSORS

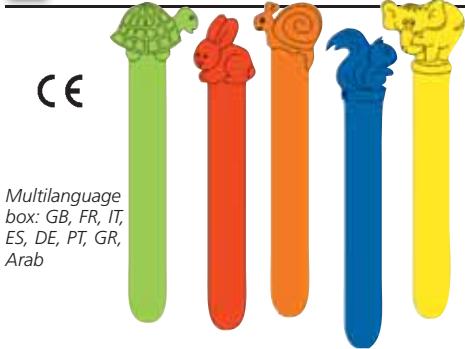

Multilanguage box: GB, FR, IT, ES, DE, PT, GR, Arab

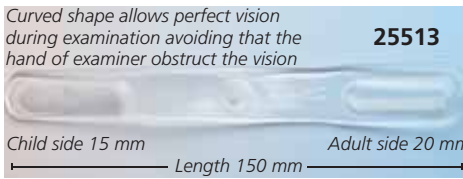

Curved shape allows perfect vision during examination avoiding that the hand of examiner obstruct the vision

Child side 15 mm      Adult side 20 mm  
Length 150 mm

**PLASTIC TONGUE DEPRESSOR**  
Translucent tongue depressors made in polystyrene with curved shape and smooth edges. One end in adult size and one end in child size. Latex and PVC free. Sterile model is individually packed in a peel-open pack (ethylene oxide).

**• 25505 PLASTIC COLOURED TONGUE DEPRESSORS**  
Plastic tongue depressor animal shaped with bright colour. Each tongue depressor is individually packed in transparent pouch. Packed in box of 50 pieces.

GIMA code	PLASTIC TONGUE DEPRESSORS ADULT/PEDIATRIC NON-STERILE	CE
25513	Tongue depressor - box of 100	CE 0120
25515	Tongue depressor - box of 90	
25516	Tongue depressor - box of 1,800 (20 boxes of 90 pcs)	

## STERILE ENT KITS

**• 31456 STERILE ENT KIT A - box of 25 pcs.** CE 0476  
Kit includes one plastic nasal speculum, one plastic tongue depressor and two (adult and pediatric size) plastic ear funnels in single sealed pouch.

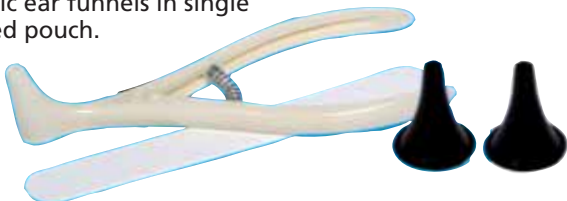

**• 31457 STERILE ENT KIT B - box of 10 pcs.** CE 0123  
Kit includes one plastic nasal speculum, one plastic tongue depressor, two (adult and pediatric size) plastic ear funnels, two plastic laryngeal mirrors, one plastic forceps, six cotton tip applicators, one napkin, all packed in a sterile plastic tray.



## THROAT SCOPE®

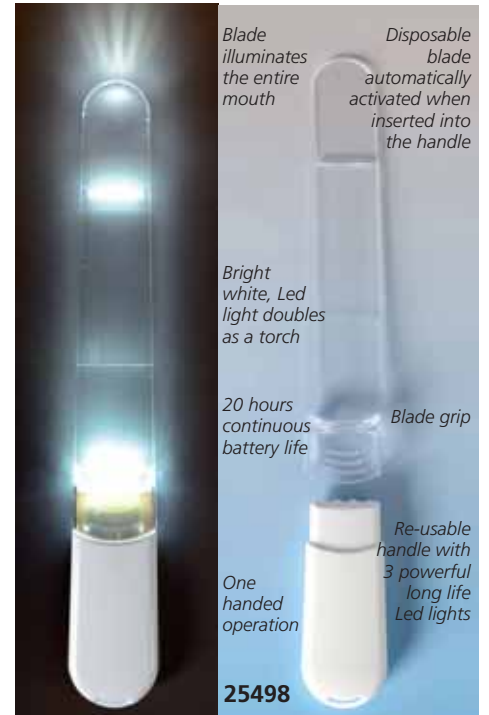

Blade illuminates the entire mouth

Disposable blade automatically activated when inserted into the handle

Bright white, Led light doubles as a torch

20 hours continuous battery life

Blade grip

Re-usable handle with 3 powerful long life Led lights

One handed operation

25498

**• 25498 THROAT SCOPE® KIT**  
**1 handle + 3 blades - blister**  
Throat Scope is an illuminated tongue depressor that allows the clinician a one handed operation for oral cavity examination. The light is guided by the blade to illuminate the mouth for a quick examination by the clinician. Light is automatically activated when you insert single use blade into the handle.

**• 25499 THROAT SCOPE® DISPOSABLE BLADES - box of 100 - non sterile**



Simultaneously depresses the tongue and illuminates the mouth

## NASAL SPECULUM



31469

The use of stainless steel speculum can be a chilling experience for the patient. Now you can combine patient comfort with effective treatment. Smooth, warm tips make disposable Nasal Speculum more comfortable and less alarming to the patient.

**• 31469 DISPOSABLE NASAL SPECULUM - box of 48**  
Innovative plastic, disposable nasal speculum with handle: allows superior view of nasal cavity. Helps extract foreign objects from nasal cavity. Facilitates packaging of cauterizing of bleeding noses. Latex free.

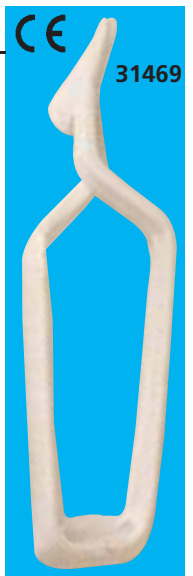

## WELCH ALLYN HALOGEN PROFESSIONAL PENLIGHT

- 25622 W.A. HALOGEN PENLIGHT with 2 x AAA batteries  
Bright white halogen light.  
Durable solid brass construction.
- 25618 BULB for W.A. PENLIGHT - spare



## TOP QUALITY BULB OR LED PENLIGHTS - MADE IN GERMANY

Professional penlights, also suitable for diagnostic, with bulb or white LED with quick clip shifter mechanism or push button (25634).

Argenta and Elegance made of anodized aluminium, Nova in top-quality ABS plastic housing. Supplied with 2x1.5V AAA batteries.



GIMA code	Description	Light	Material	Supplied with batteries	Colour	Origin	on/off by
25632	Argenta torch	bulb	metal	2 x AAA	black	Germany	Pocket clip
25633	Argenta torch	bulb	metal	2 x AAA	silver	Germany	Pocket clip
25638	Argenta torch	bulb	metal	2 x AAA	green	Germany	Pocket clip
25634	Elegance torch	bulb	metal	2 x AAA	blue	Germany	Push button
25440	Nova torch	LED	plastic	2 x AAA	white	Germany	Pocket clip
25442	Argenta torch	LED	metal	2 x AAA	blue	Germany	Pocket clip

## BULB OR LED TORCHES PENLIGHTS



GIMA code	Description	Light	Material	Supplied with batteries	Colour	Packaging	Origin	on/off by
25626	Alfa torch	bulb	plastic	2 x AAA	blue	Blister	Asia	Pocket clip
25627	Alfa torch	bulb	plastic	2 x AAA	white	Blister	Asia	Pocket clip
25639	Beta torch	bulb	stainless steel	2 x AAA	silver	Plastic case	Asia	Push button
25434	Stylo torch	bulb	metal	2 x AAA	white	Blister	Asia	Push button
25641	Spirit torch	LED	chrome plated brass	2 x AAA	silver	Box	Asia	Pocket clip
25436	Omega Torch	LED	metal	2 x AAA	silver	Plastic case	Asia	Pocket clip
25437	Omega Torch	LED	metal	2 x AAA	gold	Plastic case	Asia	Pocket clip
25624	GIMA torch	LED	metal	2 x AAA	silver	Box	Asia	Push button

## DELTA PENLIGHTS WITH TONGUE DEPRESSOR HOLDER

- 25628 DELTA "LED" PENLIGHT - red
  - 25629 DELTA "LED" PENLIGHT - blue
- Delta penlights are supplied in aluminium box with 2 AAA batteries and holder for tongue depressors (tongue depressor not included). Manual in: GB, FR, IT, ES.



- 25625 DELTA "LED" OTOSCOPE PENLIGHT - black
  - 31345 REUSABLE EAR SPECULUM 2.0 mm - bag of 25
  - 31346 REUSABLE EAR SPECULUM 4.0 mm - bag of 25
- Same as 25628-9 but with otoscope head, 3 ear funnels and 5 black plastic tongue depressors.

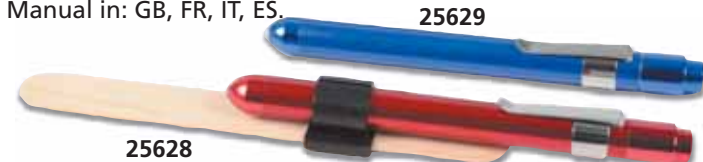

## NEUROLOGICAL REFLEX PERCUSSORS - LATEX FREE



GIMA code	PERCUSSORS	Colour	Handle	Pin	Brush	Weight	Length
31270	Buck Gima 2000	green	plastic/stainless steel	yes	yes	85 g	18 cm
31251	Buck Classic	silver	chromed brass	yes	yes	90 g	18 cm
31252	Buck colour-yellow	yellow	brass colour coated	yes	yes	90g	18 cm
31271	Dejerine Gima 2000	blue	plastic/stainless steel	yes	yes	110 g	21 cm
31254	Dejerine Classic	silver	stainless steel	yes	yes	140 g	21 cm
31255	Dejerine colour	red	brass colour coated	yes	yes	125 g	21 cm
31256	Babinsky - Ø 4.5 cm	silver	chrome plated	yes	no	170 g	24 cm
31257	Queens - Ø 5 cm	silver	flexible plastic	no	no	100 g	33 cm
31258	Troemner	silver	stainless steel	no	no	200 g	23 cm
31260	Pinwheel	silver	chrome plated	no	no	50 g	18 cm
31272	Babinsky-Gima 2000	green	plastic	no	yes	80 g	24 cm
31273	Taylor Gima	red	plastic/stainless steel	no	yes	70 g	20 cm



## NEUROLOGICAL KIT

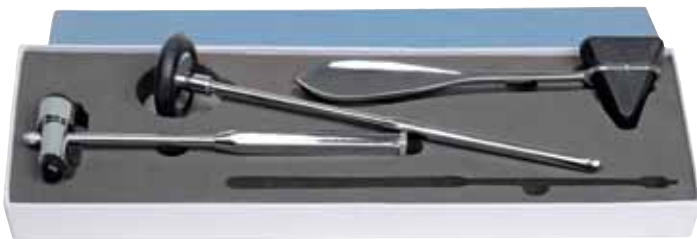

• **31265 NEUROLOGICAL KIT - 3 hammers** 31265  
This kit includes 3 metal hammers in a foam box: Taylor hammer, Buck hammer and Babinsky hammer.

## THERMO FEEL

• **31278 THERMO FEEL**  
Useful tool for diagnosis of neuropathy in diabetes patients. Both sides (one stainless steel and one plastic) are alternatively put in contact with foot skin of the patient. Patient perception of cool or warm allows a first diagnosis of diabetes.



## MONOFILAMENT - SENSORY EVALUATOR



• **31282 MONOFILAMENT TOOL - sensory evaluator**  
Plastic retractable monofilament with 3 spare monofilaments. Evaluates both diminishing and returning sensation (touch test). Examines levels of sensory function and changes in neuro status. Monofilament is calibrated at 10 g. Size: 13x2.5 cm + 4 cm monofilament  
• **31281 KIT OF 3 MONOFILAMENTS - spare**



## TWO POINTS DISCRIMINATOR

• **31279 TWO POINTS DISCRIMINATOR**  
Plastic (ABS) caliper with scale printed on aluminium plate. Two point discrimination is the ability to discern that two nearby objects touching the skin are truly two distinct points, not one. It is often tested with two sharp points during a neurological examination and reflects how finely innervated an area of skin is. Reliable and widely used technique for determining tactile gnosis.



## TRIGONAL MONOFILAMENT

• **31277 TRIGONAL MONOFILAMENT**  
Trigonal shape diabetic monofilament with 3 different monofilament diameters: 0.4, 0.5 and 0.7 mm



## GERMAN-MADE DIAPASONS - TUNING FORKS

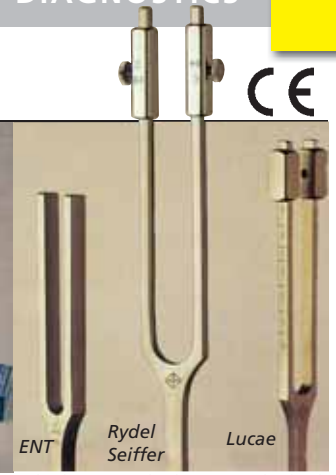
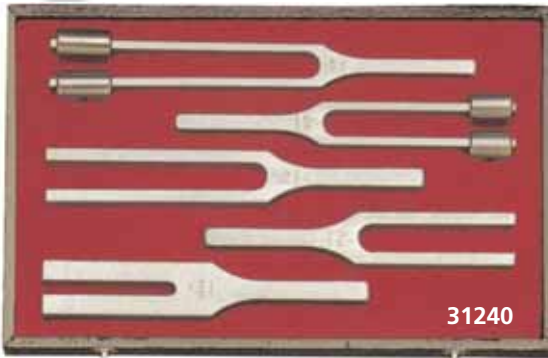

### ENT TUNING FORKS:

All made in Germany, with age-long craftsmanship experience, in special alloy that ensures maximum sound precision.

GIMA code	ENT TUNING FORKS
31230	Tuning fork 128 Hz* - with weight
31231	Tuning fork 256 Hz* - with weight
31232	Tuning fork 512 Hz
31233	Tuning fork 1024 Hz
31234	Tuning fork 2048 Hz
31235	Tuning fork 4096 Hz
31240	Set of 5 tuning forks in a stylish lined case (contains 128 Hz*, 256 Hz*, 512 Hz, 1024 Hz, 2048 Hz). <i>Tuning forks with asterisk * are supplied with weight</i>

### ENT/NEUROLOGY TUNING FORKS

All made in a special alloy and supplied with base.

GIMA code	ENT/NEUROLOGY TUNING FORKS
31245	Tuning fork a1-440 Hz - ENT - 90 g
31246	Tuning fork - LUCAE - 85 g adjustable from c128 to h240 with foot
31247	Tuning fork C64, c128 - RYDEL SEIFFER detachable slider either C64 or c128 - 130 g
31249	Hammer neurotone 5 in a lined case

Neurotone hammer: set of 5 components for a complete neurological examination: percussion hammer + tuning fork 256 Hz with weight + pin + brush. All fitted in a stylish case.



## ALUMINIUM ALLOY DIAPASONS - TUNING FORKS

- 31225 ALUMINIUM TUNING FORK 128 Hz
- 31226 ALUMINIUM TUNING FORK 128 Hz - with foot

Made of finest aluminium alloy and precisely shaped to meet highest requisites (standards) in medical field.

Resting pad for forehead

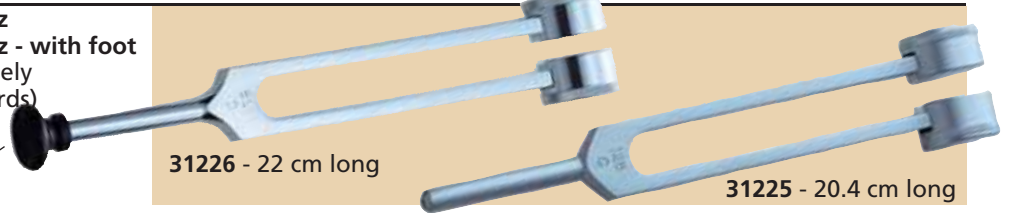

## NYSTAGMUS SPECTACLES - DR. FRENZEL - MADE IN GERMANY

- 31204 NYSTAGMUS SPECTACLES - DR. FRENZEL - black  
Easy to use in the search of spontaneous or provoked nystagmus. Fixed, biconvex lens + 18.0 diopters. Nystagmus spectacles should be connected only with < 4.2 V transformer as per safety norms 93/42/EEC. See code 31203 or 31214

- 31214 BATTERY handle for 31204  
Offers mobility during examination. Needs 3x1.5 V CLR14 batteries (not included)

- 31203 PLUG-IN TRANSFORMER for 31204
- 31206 BATTERY NYSTAGMUS SPECTACLES - DR. FRENZEL - black  
This model allows wireless working and is provided with power through the adjustable battery placed above the spectacle. Requires three 1.5 Volt batteries, size C LR14/AM-2 (baby cells). Illumination can be adjusted through a turn of the switch.

- 31208 NYSTAGMUS BULB - spare for 31204, 31206  
4 Volt 0.230 Ampere, 1 Watt threading Ø 3.5x0.35 mm
- 31207 LED BATTERY NYSTAGMUS SPECTACLES - white  
Same as 31206 with LED and inner function that makes easier watching the rashes within a particular time period (30, 60, 90 seconds).
- 31209 LED POWER SUPPLY NYSTAGMUS SPECTACLES - white  
Same as 31204 with LED and rechargeable power supply.



## USB VIDEONYSTAGMOSCOPE SYSTEMS

- 31213 VIDEO-NYSTAGMOSCOPE - USB - mask with Ir camera and USB cable  
Facilitate to view and register the Nystagmus through standard vestibular tests (both position and instrumental proof). This system allows to view on the monitor or PC/Notebook images of patient eyes during tests and to make Visual Suppression Test (VST) through a green LED light inside the mask to allow fixation. Innovative technology allows to get quality images. Power 12V DC.



## OPTOMETRIC CHARTS

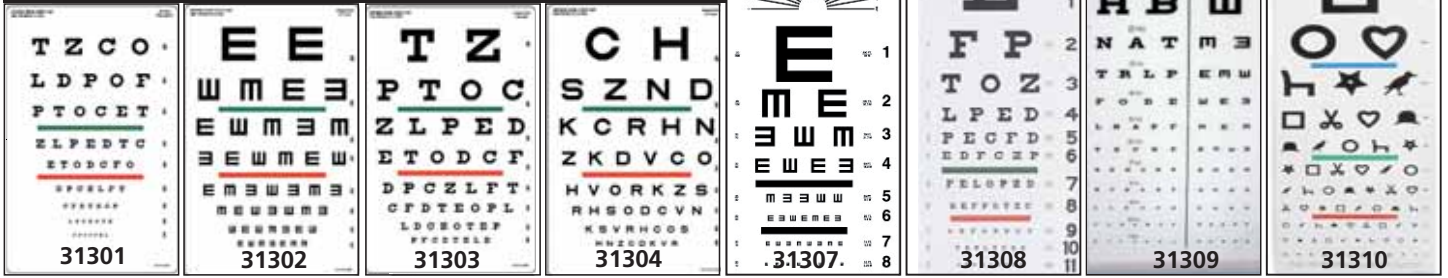

GIMA code	OPTOMETRIC CHARTS*	Working distance	Size cm
31301	SNELLEN eye chart with red/green bar visual acuity test	10 feet 3 m	23x35.5
31302	TUMBLING "E" colour vision chart-visual acuity screen	20 feet 6.1 m	23x35.5
31303	SNELLEN eye chart for visual acuity and colour vision test	20 feet 6.1 m	23x35.5
31304	SLOAN colour bar visual acuity chart	20 feet 6.1 m	23x35.5
31307	TUMBLING "E" eye chart	20 feet 6.1 m	28x56
31308	TRADITIONAL SNELLEN eye chart	20 feet 6.1 m	28x56
31309	MIXED DECIMAL chart	10 feet 3 m	28x56
31310	EWING illiterate test chart	20 feet 6.1 m	28x56
31311	SLOAN near vision chart (2 sides printed)	16 inches 40 cm	18x23

\*Polypropylene natural white sheet, approx. thickness 0.8 to 1.0 mm

## LEA SYMBOLS AND NUMBERS VISION CARDS AND CHARTS



**31322 LEA SYMBOLS NEAR VISION CARD - 40 cm (16 inches)**

This test measures near visual acuity with proportionally spaced (logMAR) lines on the front and lines with 25% and 50% spacing on the back. Response key printed on test card. Includes training cards and instructions. Card measures 20.3x25.4 cm (8x10").

**31323 LEA SYMBOLS 15-LINE DISTANT CHART - 3 m (10 feet)**

This test is designed for vision screening at schools and assessment of vision of children with special needs beginning with age of 3 years. Has a hole for hanging the chart on the wall. Includes response key, training cards, and instructions. 43x53.4 cm (17x21"). Folds to 43x26.7 (17x10.5").

**31324 LEA NUMBERS NEAR VISION CARD - 40 cm (16 inches)**

Designed to measure visual acuity with a standard line test and with three tighter spaced tests; 50%, 25%, and 12.5%, which often reveal difficulties in seeing tightly crowded details. Card measures 20.3x25.4 cm (8x10").

**31325 LEA NUMBERS 15-LINE DISTANT CHART - 3 m (10 feet)**

This test is designed for vision screening at schools and assessment of vision of children with special needs beginning with age of 5 years. Has hole for hanging on the wall. 45.7x50.8 cm (18x20"). Folds to 45.7x25.4 (18x10").

## LOW CONTRAST CHARTS

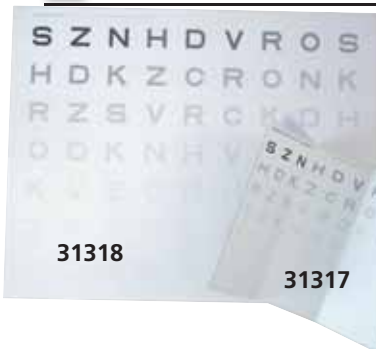

**31317 CONTRAST SENSITIVITY CARD - NEAR VISION 40 cm size 40x34 cm**

**31318 CONTRAST SENSITIVITY CHART - FROM A DISTANCE 3 m size 77x61 cm**

It checks for the ability to distinguish light and dark (contrast). It can detect vision problems. Also useful to reveal in time regression or progression of the cataract disease.

## OCCLUDERS



**31275 EYE OCCLUDER - 170x200x3 mm**

**31274 OCCLUDER - 154 x Ø 47 mm**

**31276 FUN FROSTED OCCLUDER GLASSES**  
Set of two tiger fun frosted glasses to be used as occluder during children examinations one to occlude each eye.

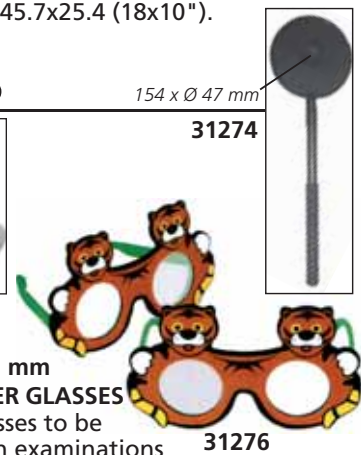

## OPTOMETRIC PENCILS

**31319 OPTOMETRIC PENCILS - set of 2 pcs**

Set of two wooden puppets (red and white) used to capture attention during vision evaluation in young non-verbal children. Can also be used for test of convergence.

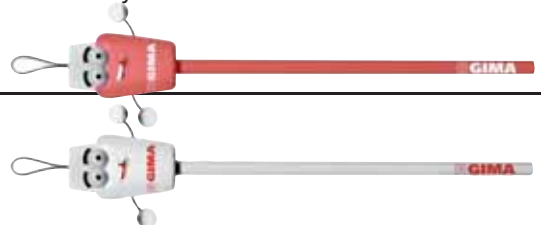

## ISHIHARA COLOUR TEST

### ISHIHARA Colour TEST

These series of plates are designed to provide a test which gives a quick and accurate assessment of colour vision deficiency of congenital origin. This is the most common form of colour vision disorders. Most cases of congenital colour vision deficiency are characterized by a red-green deficiency which may be of two types: a protan type which may be absolute (protanopia) or partial (protanomaly), and a deutan type which may be absolute (deutanopia) or partial (deutanomaly).



GIMA code	ISHIHARA COLOUR TEST
31290	Book of 10 plates for illiterates
31291	Book of 24 plates
31292	Book of 38 plates

## STEREOPSIS TESTS

- 31283 FLY STEREO ACUITY TEST
- 31284 BUTTERFLY STEREO ACUITY TEST 31284

Designed to rapidly test for amblyopia and strabismus using gross to fine stereopsis (4800 to 20 sec of arc):

- graded circle test from 400 sec now down to 20 sec
- new technology → no monocular clues
- answer key on back cover
- includes pair of standard polarised viewers

- 31285 RANDOM DOT STEREO ACUITY TEST

Designed to rapidly test for amblyopia and strabismus in early and non-readers and non-verbal children and adults

- expanded random dot lea test (500, 250, 125, 63 sec of arc)
- graded circle test now down to 12.5 sec
- answer key on back cover
- includes pair of standard polarised viewers



## STEREOPTIC TEST

- 31293 STEREOPTIC TEST

This test is performed at a distance of 30-40 cm and allows evaluation of the cooperation between the two eyes to form a single image to the brain from the two image provided separately by each of the two eyes.

It can be used for children from the age of one year and adults if you suspect strabismus, amblyopia or visual reduction of one or both eyes.

*Gima stereoptic test contains one ball, one fish, one star, one tree. Ball can be seen by one eye only.*

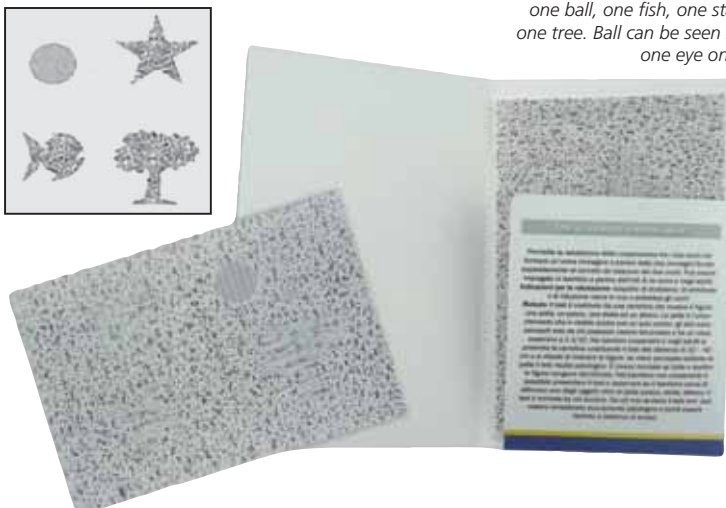

## GIMA COLOUR TEST

- 31287 GIMA ADULT COLOUR TEST - 15 plates
  - 31286 GIMA PEDIATRIC COLOUR TEST - 10 plates
- Single plates packed in a practical aluminium box.



## WORTH LED LIGHT TEST

- 31289 WORTH LED LIGHT TEST - with red/green glasses
- The Worth 4 dot test, is a clinical test for suppression of either the right or left eye. Suppression occurs during binocular vision, when the brain does not process the information received from either of the eyes. This is a common adaptation to strabismus, amblyopia, and aniseikonia. Battery not included, glasses included.



## LANG STEREO TEST

- 31294 LANG STEREO TEST I
- 31295 LANG STEREO TEST II

Stereotest I was created to simplify stereopsis screening in children. It is based on two principles: on random dots and on cylinder gratings.

Stereotest II is a further development and helps the assessment of binocular vision.



- 31296 LANG FIXATION STICK



- 31297 LANG FIXATION CUBE - white



- 31298 LANG FIXATION CUBE - red

## SCHIÖTZ TONOMETER



- 31220 SCHIÖTZ TONOMETER - straight scale
- 31222 SCHIÖTZ TONOMETER - inclined scale

A masterpiece of precision mechanism, measures intraocular pressure according to Prof. Schiötz standards.

Vital parts are made of stainless steel. High quality agate bearing for extremely long service life.

Set 3 weights included (5.5-7.5-10 g). Scale specification 5. In black deluxe case with velvet-look inserts.

Perfect reading of the scale with red pointer. Made in Germany.



31220 straight



31222 inclined



## TRAD STETHOSCOPES - GOOD VALUE FOR MONEY



**TRAD STETHOSCOPES: adult, pediatric**  
 Traditional aluminium stethoscopes, lightweight and reliable.  
 Chestpiece diaphragm Ø 43.5 mm (Ø 35 for pediatric model), bell Ø 30 mm (Ø 26.5 for pediatric model) external sizes.  
 Brass binaural, non chill ring.  
 Tubing: length 62 cm, int. Ø 4 mm, ext. Ø 8 mm.  
 Supplied in cardboard box. Manual and box in 11 languages: GB, FR, IT, ES, DE, PT, GR, PL, HU, SE, Arabic.



GIMA code	TRAD STETHOSCOPES - LATEX FREE	
32557	TRAD single head - pediatric - pink	
32559	TRAD single head - pediatric - light blue	
32555	TRAD double head - pediatric - black	
32560	TRAD single head - black	
32561	TRAD single head - red	
32562	TRAD single head - blue	
32563	TRAD single head - yellow	
32564	TRAD single head - purple	
32558	TRAD single head - dark green	
32565	TRAD double head - black	
32566	TRAD double head - red	
32567	TRAD double head - blue	
32568	TRAD double head - dark green	
32678	Diaphragm Ø 44 mm - spare	

## COVERS FOR STETHO

GIMA code	COVERS FOR STETHOSCOPES*	
32653	Pig cover for stethoscopes	
32654	Dragon cover for stethoscopes	
32652	Cow cover for stethoscopes	

\*For pediatric applications, fits every kind of stethoscopes. Other shapes available for quantitative



## SPARE PARTS AND ACCESSORIES FOR STETHOSCOPES

GIMA code	QUALITY "Y" TUBING	Minimum order
32620	"Y" tubing mixed colours	box of 20
32621	"Y" tubing - black	box of 20
32622	"Y" tubing - green	box of 20
32623	"Y" tubing - blue	box of 20
32624	"Y" tubing - red	box of 20
32625	"Y" tubing - orange	box of 20
32626	"Y" tubing - light blue	box of 20
32627	"Y" tubing - yellow	box of 20
32628	"Y" tubing - purple	box of 20
32629	"Y" tubing - pink	box of 20
32645	"Y" tubing - other colours on request*	box of 20

\*Over 20 colours available: frosted green/lilac/blue/mell/pink, lavender, teal, ice blue, grey...



BINAURAL - DIAPHRAGM - HEADS		
32655	One head chest piece - black ring	10 pcs.
32656	Dual head chest piece - black ring	10 pcs.
32665	SNOWDEN binaural - folding	10 pcs.
32666	BERTA binaural - fixed	1
32678	Diaphragm Ø 45mm for Classic adult	10 pcs.
EARTIPS AND ADAPTORS		
32659	Standard eartips - rigid - universal	10 pieces
32663	Mushroom eartips - universal	10 pieces
32664	Rigid eartips screw-type - for Classic, Wan, Yton, Duca, Regalite	10 pieces
32660	Male-female adaptor	10 pieces



## WAN STETHOSCOPES - ADULT



### WAN ADULT STETHOSCOPES

Features a chrome-plated zinc-alloy chestpiece, a screw-on plastic retaining ring, outer spring binaural and colour matched moulded PVC tubing with non-chill ring. Assure optimum acoustic performances. Chestpiece: Ø 45 mm, bell Ø 30 mm. Tubing: length 63 cm, int. Ø 4.2 mm, ext. Ø 8 mm. Supplied in a cardboard box. Manual and box in 11 languages: GB, FR, IT, ES, DE, PT, GR, PL, HU, SE, Arabic.

GIMA code	WAN STETHOSCOPES - LATEX FREE	
32569	WAN single head adult - black	■
32570	WAN single head adult - blue	■
32571	WAN single head adult - burgundy	■
32572	WAN single head adult - orange	■
32574	WAN double head adult - black	■
32575	WAN double head adult - blue	■
32576	WAN double head adult - burgundy	■
32577	WAN double head adult - orange	■
32678	Diaphragm Ø 44 mm - spare	

## PEDIATRIC-NEONATAL STETHOSCOPES



### WAN PEDIATRIC AND NEONATAL STETHOSCOPES:

Features a chrome-plated zinc-alloy chestpiece, a screw-on plastic retaining ring, outer spring binaural and colour matched moulded PVC tubing with non-chill ring. Assure optimum acoustic performances. Chestpiece: Ø 35 mm, bell Ø 30 mm, (pediatric) or Ø 22 mm, bell Ø 19 mm (neonatal). Tubing length: 63 cm. Supplied in a cardboard box. Manual and box in 11 languages: GB, FR, IT, ES, DE, PT, GR, PL, HU, SE, Arabic.

### WAN PLUS:

Same as standard with inner spring binaural, superior tubing quality and 2 pair of soft colour coordinated ear tips in different size.

GIMA code	WAN STETHOSCOPES - LATEX FREE	
32508	WAN double head neonatal - red	■
32509	WAN double head neonatal - grey	■
32513	WAN double head pediatric - light-blue	■
32515	WAN double head pediatric - red	■
32511	WAN PLUS double head pediatric - pink	■
32506	WAN PLUS double head pediatric - black	■

## DESIGN STETHOSCOPES



- 32527 DESIGN STETHO - transparent blue
- 32528 DESIGN STETHO - transparent purple

High quality single head stethoscope with fashionable design diaphragm and "Superflex TM" binaural. Provides high acoustic performances thanks to its quality components. Head and tube are in transparent coordinated colour.

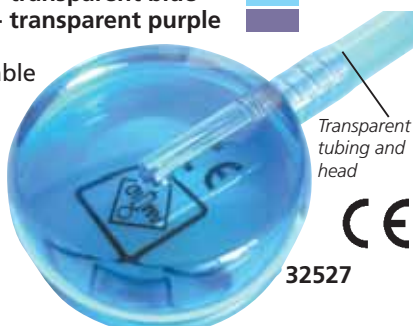

## YTON STETHOSCOPES



### YTON STETHOSCOPES:

Chestpiece Ø 45 mm, bell Ø 30 mm (for double head), with colour coordinated plastic retaining ring. "Duracote" finished. Supplied in cardboard box. Manual and box in 11 languages: GB, FR, IT, DE, ES, PT, GR, PL, SE, HU, Arabic.

GIMA code	YTON STETHOSCOPES - LATEX FREE	
32514	Yton single head - green teal colour	■
32530	Yton double head - green teal colour	■



# JOTARAP STETHOSCOPE: DOUBLE-HEAD, DOUBLE TUBE



Gima Sprague Rappaport type double-head, double-tube, latex free stethoscope at the price of a standard stethoscope. **5 in 1, five way convertible type stethoscope**  
 This convertible stetho, zinc alloy treaded with chrome plated chestpiece drum fitting with different sized chestpieces bells, provides versatile acoustics for infants and adults for the detection of a wide range of heart and lung sounds.

GIMA code	JOTARAP STETHOSCOPE	
32579	JOTARAP - purple	
32580	JOTARAP - black	
32581	JOTARAP - blue	
32582	JOTARAP - neon orange	
32583	JOTARAP - green	
32584	JOTARAP - neon yellow	
32585	JOTARAP - light blue	
32586	JOTARAP - fuchsia	
32587	JOTARAP - transparent pink	
32590	ACCESSORY KIT - spare	

Chestpiece with small and large diaphragm. **Double tubing for individual sound transmission**

Two separate 56 cm (22") thick latex free wall tubing provide individual sound transmission from chestpiece to both sides of the ear. **Complete in cardboard box with accessory kit (32590)**

It is supplied with an accessory pouch containing:  
 3 interchangeable plastic black non-chill bells, adult and pediatric spare diaphragm, one pair clear neoprene eartips, one pair black mushroom eartips.  
 10 languages manual (GB, FR, DE, IT, ES, PT, GR, PL, HU, Arabic).

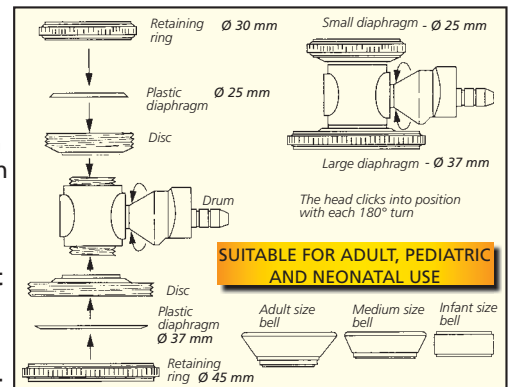

# LINUX STETHOSCOPES

Chestpiece Ø: 44 mm  
 Tubing: length 62 cm  
 int. Ø 4 mm  
 ext. Ø 8 mm



- 32518 LINUX STETHOSCOPE - blue
- 32524 LINUX STETHOSCOPE - black
- 32529 LINUX STETHOSCOPE - red

Single head stethoscope with lightweight zinc alloy chestpiece plated with an attractive satin finish. The special design assures better performances by pushing the back of the head.

Non-chill diaphragm retaining rim for patient comfort. Stainless steel binaurals fixed at 15° angle for greater comfort and acoustic seal. Soft and flexible PVC tubing. Supplied in deluxe box with one pair of plastic eartips and PVC eartips. Manual and box in 11 languages: GB, FR, IT, ES, DE, PT, GR, PL, HU, SE, Arabic.

## CARDIOLOGY STETHOSCOPES

- 32550 CARDIOLOGY CLASSIC STETHOSCOPE - blue
  - 32551 CARDIOLOGY CLASSIC STETHOSCOPE - burgundy
  - 32552 CARDIOLOGY CLASSIC STETHOSCOPE - black
- Cardiology Classic offers acoustical excellence in a traditional design with superior durability. Its innovative features include:
- stainless steel chestpiece (diameter 33-44 mm) with extra deep cone-shaped bell for a superb low frequency response
  - stainless steel double inner spring binaural
  - ultra-sensitive diaphragm for unsurpassed amplification
  - durable, elegantly moulded 55.5 cm (22") PVC tubing (int. Ø 6.5 mm, ext. Ø 12 mm)
- Manual and box in 11 languages: GB, FR, DE, IT, ES, PT, GR, PL, HU, SE, Arabic.

- 32678 DIAPHRAGM Ø 44 mm - spare

Colour coordinated non-chill ring and diaphragm retaining ring, PVC tubing



It comes in a foam lined box with 2 extra set of PVC eartips



32552



32552

## PROFESSIONAL STETHOSCOPE

- 32526 REGALITE - black
- Top quality single head stethoscope. Patented multi-frequency "ring-o-raised™" diaphragm system. Chromed plated chestpiece with "SUPERFLEX" inner spring binaural and 1 piece moulded, latex free, PVC tubing. Supplied in deluxe box, with spare soft eartips and one spare diaphragm. Manual and box in 7 languages: GB, FR, IT, ES, PT, GR, Arabic.



32526

CE

## LYNX MULTI-FUNCTIONAL VISUAL STETHOSCOPE

- 32596 LYNX MULTI-FUNCTION STETHOSCOPE with SpO<sub>2</sub> probe, USB cable and adapter
  - 32598 SpO<sub>2</sub> PROBE - spare
- Multi-function visual stethoscope with real time display of ECG waveform, heart rate and pulse oximeter.
- compact and portable, easy to use
  - adjustable screen contrast
  - adult SpO<sub>2</sub> sensor
  - alarm function for SpO<sub>2</sub> and Pulse rate
  - low power consumption
- Multilanguage box and manual: GB, FR, IT, ES



32596

CE 0123

### TECHNICAL SPECIFICATIONS

<b>Heart rate</b>	Measurement range: 30 - 300 bpm	<b>SpO<sub>2</sub></b>	Measurement range: 0% - 100%
	Accuracy: ±2 bpm		Accuracy: 70% - 100% ±2%, <70% unspecified
<b>Pulse rate</b>	Measurement range: 30 - 250 bpm	<b>Other</b>	Power supply: Rechargeable lithium battery DC 3.7 V
	Accuracy: ±2 bpm or ±2% (select larger)		Display: 2.7" LCD
			Size: 87x63x19 mm

## MULTI-FUNCTIONAL VISUAL STETHOSCOPE

- 32597 MULTI-FUNCTION VISUAL STETHOSCOPE with SpO<sub>2</sub> probe, USB cable and adapter, earphone
  - 32598 SpO<sub>2</sub> PROBE - spare
- The device includes stethoscope function and displays ECG waveform, heart rate, SpO<sub>2</sub>, pulse and pulse waveform. Suitable for hospital, clinic, medical community and family.
- compact, light and portable, easy to use
  - earphone output and adjustable volume
  - alarm for SpO<sub>2</sub> and pulse rate exceeding limits
  - real-time detecting, data storage and review
  - real-time clock
  - recorded data can be transferred to PC
  - PC analysis software
  - low power consumption
- Multilanguage box and manual: GB, FR, IT, ES

CE 0123

32597



### TECHNICAL SPECIFICATIONS

<b>Stethoscope</b>	Heart: 20 - 230 Hz	<b>Pulse rate</b>	Measuring range: 30 - 250 bpm	<b>Other</b>	Battery: 3.7 V rechargeable lithium battery
	Lung: 100 - 800 Hz		Accuracy: ±2 bpm or ±2% (select larger)		Display: 2.4" colour TFT
	H&L: 20 - 800 Hz	<b>SpO<sub>2</sub></b>	Measuring range: 0% - 100%		Size: 110x60x14 mm
<b>Heart rate</b>	Measuring range: 30 - 300 bpm		Accuracy: 70 - 100% (±2%) <70% unspecified		
	Accuracy: ±2 bpm				

# ACOUSTIC EXCELLENCE DOUBLE HEAD STETHOSCOPES



**CLASSIC STAINLESS STEEL STETHOSCOPES - Adult and Pediatric**  
 High quality stethoscope with stainless steel chestpiece, stainless steel double inner spring binaural and durable, elegantly moulded PVC tubing for unsurpassed acoustic performance. The colour coordinated flexible 55 cm (22") PVC "Y" tubing, non-chill ring and diaphragm retaining ring provide excellent patient comfort, while adding attractiveness. It comes in a foam lined box with 2 extra sets of soft eartips. Chestpiece: Ø 45 mm (adult), Ø 35 mm (pediatric). Manual and box in: GB, FR, DE, IT, ES, PT, GR, PL, HU, SE, Arabic.

**CLASSIC IN 11 COLOURS**

Black	Dark blue	Royal blue	Light blue	Green	Dark green	Burgundy	Orange	Red	Pink	Lilac
GIMA code	ACCESSORIES - SPARES									
32678	Diaphragm Ø 44 mm - spare for Classic adult									
32664	Rigid eartips screw-type - white spare for Classic/Wan/Yton/Duca/Regalite									

GIMA code	CLASSIC DOUBLE HEAD S/S STETHOSCOPES - ADULT
32531	Classic adult - dark green
32532	Classic adult - orange
32533	Classic adult - light blue
32534	Classic adult - black
32535	Classic adult - burgundy
32536	Classic adult - dark blue
32537	Classic adult - green
32538	Classic adult - red
32539	Classic adult - pink
32540	Classic adult - royal blue
32541	Classic adult - lilac
	<b>CLASSIC DOUBLE HEAD S/S TEACHING STETHOSCOPES</b>
32542	Classic Teaching - black <i>allows simultaneously auscultation by 2 people</i>
	<b>CLASSIC DOUBLE HEAD S/S STETHOSCOPES - PEDIATRIC</b>
32512	Classic pediatric - light-blue
32516	Classic pediatric - black



# RIESTER DUPLEX® 2.0 STETHOSCOPES, SIMPLY BETTER HEARING



**RIESTER DUPLEX® 2.0 STAINLESS STEEL STHETOSCOPES**  
 Duplex® 2.0 sthetoscopes are distinguished by outstanding acoustic performance. They have been completely new constructed to meet the challenges of daily diagnostic practice. Special design tube for better auscultation of adults, children/babies or new-borns.

- precision double chest-piece made of stainless steel with innovative membrane support
- anatomically shaped binaural with internal multiple spring for adjusting the contact pressure
- extra-soft, replaceable and pivotable ear-tips for perfect sealing at the ear canal and enhanced wear comfort
- innovative acoustic system with extraordinary auscultation for all frequency ranges

- special membrane for precise acoustics with novel non-chill rims for improved adaptation on the skin  
 Supplied with name plate, replacement ear-tips and membrane.

GIMA code	Riester code	RIESTER DUPLEX® 2.0 - STAINLESS STEEL - LATEX FREE	Membrane	Length	Weight
		<b>DUPLEX® 2.0 ADULT</b>			
32333	4210-01	Duplex® 2.0 - black	Ø 44 mm	74 cm	151 g
32334	4210-02	Duplex® 2.0 - white	Ø 44 mm	74 cm	151 g
32335	4210-03	Duplex® 2.0 - blue	Ø 44 mm	74 cm	151 g
32336	4210-04	Duplex® 2.0 - red	Ø 44 mm	74 cm	151 g
		<b>DUPLEX® 2.0 PEDIATRIC</b>			
32338	4220-02	Duplex® 2.0 - white	Ø 32/23.5 mm	69 cm	124 g
		<b>DUPLEX® 2.0 NEW-BORN</b>			
32340	4230-02	Duplex® 2.0 - white	Ø 24/17.5 mm	69 cm	105 g

## ERKA FINESSE STHETOSCOPIES - MADE IN GERMANY

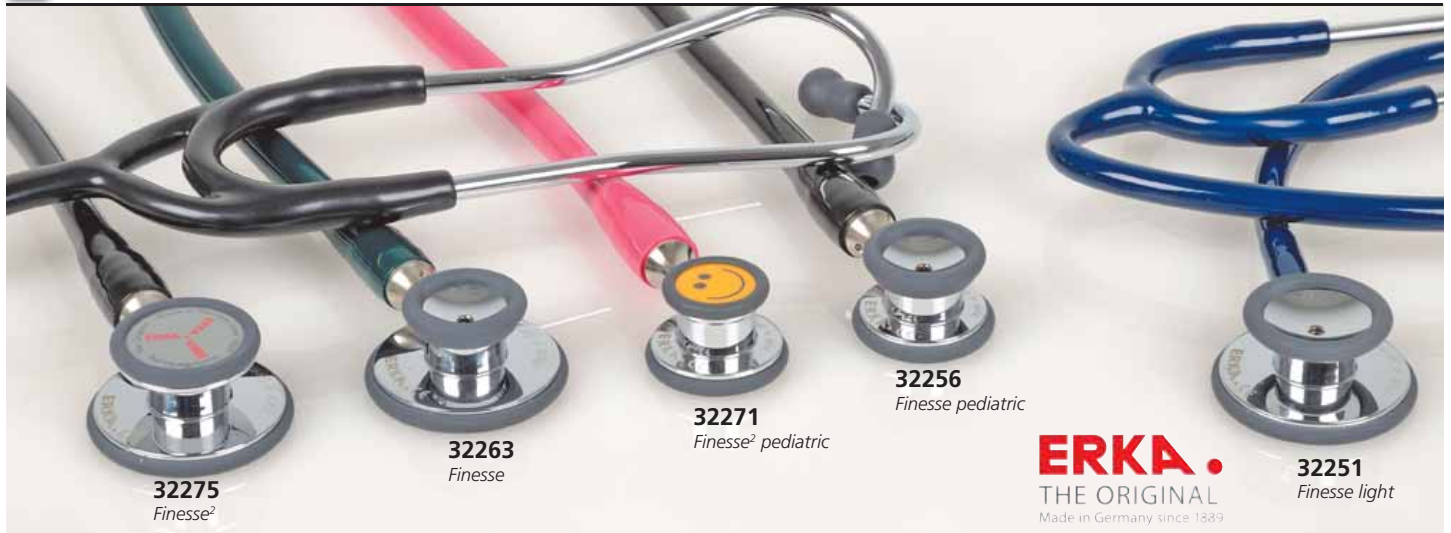

### FINESSE STETHOSCOPIES

With the reversible double chest-piece you'll be prepared for all eventualities in everyday medical practice. The membrane side guarantees optimal auscultation for the entire frequency spectrum and the open bell side is specifically designed for low frequencies.

### FINESSE<sup>2</sup> STETHOSCOPIES

The reversible, combined chest-piece has two membrane sides, each making the full frequency range perfectly audible. The large membrane is suitable for auscultation of adults and the small one for children or slim patients.

All Erka stethoscopes are supplied with carrying bag



FEATURES	Finesse Light	Finesse Finesse <sup>2</sup>
Pre-tensioned ERKA. convex membrane provides excellent resonance and sound.	X	X
Non-chill ring ensures highest patient comfort.		X
Superior polish, chromium-plated, non-porous surface and brass chest-piece ensure perfect surface hygiene.	X	X
Two internal channels run parallel in the stethoscope tubing preventing any noise caused by friction of two separate tubes.		X
Through the separately integrated spring in the tube, there is no acoustic loss from the chest-piece to the ear.		X
Ergonomic design and super soft tips provide excellent acoustic seal against external noise interference and maximize user's comfort.	X	X
Standard 15° inclined binaurals can be individually adapted to the specific ear canal of the user.	X	X

GIMA code	ERKA code	ERKA STETHOSCOPIES - tubing length - 55 cm
<b>FINESSE LIGHT ADULT - head Ø 44.5/33.5 mm</b>		
32250	520 000 00	■ Finesse light - black
32251	520 000 20	■ Finesse light - navy blue
32252	520 000 55	■ Finesse light - dark green
<b>FINESSE PEDIATRIC - head Ø 31/26.5 mm</b>		
32256	549 000 00	■ Finesse pediatric - black
32257	549 000 25	■ Finesse pediatric - light blue
32258	549 000 35	■ Finesse pediatric - pink
<b>FINESSE ADULT - head Ø 44.5/33.5 mm</b>		
32262	550 000 00	■ Finesse adult - black
32263	550 000 05	■ Finesse adult - dark grey
32264	550 000 20	■ Finesse adult - navy blue
32265	550 000 55	■ Finesse adult - dark green
32266	550 000 60	■ Finesse adult - burgundy
<b>FINESSE<sup>2</sup> PEDIATRIC - head Ø 30/21.3 mm</b>		
32270	536 000 00	■ Finesse <sup>2</sup> pediatric - black
32271	536 000 35	■ Finesse <sup>2</sup> pediatric - pink
<b>FINESSE<sup>2</sup> ADULT - head Ø 47/30 mm</b>		
32275	535 000 00	■ Finesse <sup>2</sup> adult - black
32276	535 000 05	■ Finesse <sup>2</sup> adult - dark grey
32277	535 000 20	■ Finesse <sup>2</sup> adult - navy blue

## ERKAPHON STETHOSCOPIES - MADE IN GERMANY



Stethoscope with double chest piece is switchable from membrane to bell function. The membrane side is suitable for the auscultation of high and low frequency sounds while the bell side is designed for cardiac impulses.

### ERKAPHON STETHOSCOPIES:

High quality precision stethoscopes for excellent acoustics, made in Germany.

All stethoscopes are equipped with 56 cm long Y tube, brass chrome-plated binaural and chest-piece (32350, 32358) or aluminium (32344-7), membrane Ø 44 mm, bell Ø 30 mm (32358 only).

GIMA code	ERKA code	ERKAPHON STETHOSCOPIES
<b>ERKAPHON FLAT CHESTPIECE - aluminium</b>		
32344	544 000 10	Erkaphon flat chestpiece - black
32345	544 000 20	Erkaphon flat chestpiece - navy blue
32346	544 000 25	Erkaphon flat chestpiece - light blue
32347	544 000 30	Erkaphon flat chestpiece - red
<b>ERKAPHON FLAT CHESTPIECE - chromed</b>		
32350	543 000 10	Erkaphon flat chestpiece - black
<b>ERKAPHON DOUBLE CHESTPIECE - chromed</b>		
32358	541 000 10	Erkaphon double chestpiece - black

# 3M™ LITTMANN® STETHOSCOPES USER GUIDE

## LITTMANN STETHOSCOPES

3M Littmann stethoscopes offer exceptional acoustic features. Each model has been created for a specific professional need.

The following guide will allow customers to select the model more suitable to his profession and preferred colour.

	Lightweight		Classic				Cardiology			Electronic
OCCUPATION	Lightweight	Select	Master Classic II	Classic III	Classic II SE	Classic II Paediatric or Infant	Master Cardiology	Cardiology IV	Cardiology III	3200 3100
Emergency Physician			••	•••	••					
General Practitioner			••	•••	••					•••
Pediatrician			••	•••	••	••				
Medical Student			••	•••	••					
Veterinarian			••	•••	••					
Neurologist			••	•••	••					
Nurse	••	••		•	•					
Cardiologist							••	••	••	•••
Anesthetist							•	••	••	•••
Respiratory Specialist							•	••	••	•••
Internist							•	•	•	•••



## 3M™ LITTMANN® SELECT

The 3M Littmann® Select Stethoscope is ideal for general examination purposes, including blood pressure measurement. The patented single-sided chestpiece for both low and high frequency sounds offers acoustic clarity.

Head Ø 44 mm

32400



## 3M™ LITTMANN® LIGHTWEIGHT II



Authorized Distributor

Standard length 71 cm

Lightweight only 118 g

Headset made of aerospace alloy

32391



Tunable diaphragm for easy low and high frequency monitoring

GIMA code	3M code	3M™ LITTMANN® SELECT STETHOSCOPES - length 71 cm
32397	2292	•• Littmann® Select - pearl pink
32398	2294	•• Littmann® Select - violet
32399	2306	•• Littmann® Select - ocean blue
32400	2298	•• Littmann® Select - royal blue
32401	2293	•• Littmann® Select - burgundy
32403	2290	•• Littmann® Select - black
32282	2291	•• Littmann® Select - caribbean blue
32283	2296	•• Littmann® Select - raspberry
32396		•• Littmann® Select - colour on request*

\*Minimum order 3 pieces

GIMA code	3M code	3M™ LITTMANN® LIGHTWEIGHT II S.E.
32389	2452	•• Littmann® Lightweight II S.E. - caribbean blue
32390	2450	•• Littmann® Lightweight II S.E. - black
32391	2451	•• Littmann® Lightweight II S.E. - burgundy
32392	2454	•• Littmann® Lightweight II S.E. - ceil blue
32393	2453	•• Littmann® Lightweight II S.E. - lilac
32394	2455	•• Littmann® Lightweight II S.E. - metal green
32395		•• Littmann® Lightweight II S.E. - colour on request*

\*Minimum order 3 pieces

## 3M™ LITTMANN® MASTER CLASSIC II

OTHER COLOURS ON REQUEST AVAILABLE IN 20 DAYS



MASTER CLASSIC II



MASTER CLASSIC II BLACK EDITION

GIMA code	3M code	3M™ LITTMANN® MASTER CLASSIC II STETHOSCOPES length 69 cm - head Ø 44 mm
32425	2146	•• Littmann® Master Classic II - burgundy
32426	2144L	•• Littmann® Master Classic II - black
32427	2147	•• Littmann® Master Classic II - navy blue
32364	2630	•• Littmann® Master Classic II - caribbean blue
32366	2633	•• Littmann® Master Classic II - ceil blue
32367	2632	•• Littmann® Master Classic II - violet
32471	2141	•• Littmann® Master Classic II - "black edition"
32365		•• Littmann® Master Classic II - colour on request

## 3M™ LITTMANN® CLASSIC III STETHOSCOPES



The 3M™ Littmann® Classic III™ Stethoscope offers high acoustic sensitivity for exceptional performance when doing general physical assessments. It features dual tunable diaphragms and updated design.

- high acoustic sensitivity
- dual single-piece tunable diaphragms (pressure sensitive)
- versatile adult and pediatric two-sides chestpiece
- small-side diaphragm prevents debris in open bell
- snap tight soft-sealing eartips
- next generation longer-life tubing
- small side converts to open bell



Authorized Distributor

CLASSIC III - RASPBERRY - RAINBOW FINISH

GIMA code	3M code	3M™ LITTMANN® STETHOSCOPES - length 69 cm
<b>CLASSIC III - head Ø 43/33 mm</b>		
32290	5620	■ Littmann® Classic III - black
32291	5622	■ Littmann® Classic III - navy blue
32292	5626	■ Littmann® Classic III - raspberry
32293	5627	■ Littmann® Classic III - burgundy
32294	5639	■ Littmann® Classic III - rose pink
32295	5832	■ Littmann® Classic III - lavender
32296	5835	■ Littmann® Classic III - turquoise
32297	5839	■ Littmann® Classic III - lemon - lime
32298	5840	■ Littmann® Classic III - emerald
32299	5621	■ Littmann® Classic III - grey
32300	5623	■ Littmann® Classic III - caribbean blue
32301	5624	■ Littmann® Classic III - hunter green
32302	5629	■ Littmann® Classic III - orange
32303	5630	■ Littmann® Classic III - ceil blue
32304	5633	■ Littmann® Classic III - pearl pink
32305	5829	■ Littmann® Classic III - lime green
32306	5831	■ Littmann® Classic III - plum
<b>CLASSIC III SPECIAL EDITION - head Ø 43/33 mm</b>		
32308	5870	■ Littmann® Classic III - black - rainbow finish
32309	5871	■ Littmann® Classic III - raspberry - smoke finish
32310	5803	■ Littmann® Classic III - black edition
32311	5809	■ Littmann® Classic III - chocolate - copper finish
32312	5806	■ Littmann® Classic III - raspberry - rainbow finish
32313	5807	■ Littmann® Classic III - caribbean blue - rainbow finish
32314	5811	■ Littmann® Classic III - black - smoke finish
32315	5812	■ Littmann® Classic III - dark olive green - smoke finish
32316	5867	■ Littmann® Classic III - navy blue - black finish
32317	5868	■ Littmann® Classic III - burgundy - black finish
32318	5869	■ Littmann® Classic III - caribbean blue - black finish



## 3M™ LITTMANN® CLASSIC II STETHOSCOPES



**OTHER COLOURS ON REQUEST**  
Available in 20 days  
Please indicate 3M code

\*Minimum order 3 pieces

CLASSIC II INFANT



CLASSIC II PEDIATRIC



CLASSIC II SE



CLASSIC II SE SPECIAL FINISH



GIMA code	3M code	3M™ LITTMANN® STETHOSCOPES - length 71 cm
<b>CLASSIC II PEDIATRIC - head Ø 33/25 mm</b>		
32382	2115	■ Littmann® Classic II ped. - pearl pink
32383	2155	■ Littmann® Classic II ped. - orange
32384	2136	■ Littmann® Classic II ped. - royal blue
32385	2123	■ Littmann® Classic II ped. - navy blue
32386	2131	■ Littmann® Classic II ped. - pine green
32404	2113	■ Littmann® Classic II ped. - black
32405	2119	■ Littmann® Classic II ped. - caribbean blue
32406	2113R	■ Littmann® Classic II ped. - red
32407	2122	■ Littmann® Classic II ped. - raspberry
32408	2154	■ Littmann® Classic II ped. - peach
32381	2153	■ Littmann® Classic II ped. - caribbean blue - rainbow finish
32387		■ Littmann® Classic II ped. - colour on request*
<b>CLASSIC II INFANT - head Ø 27/19 mm</b>		
32376	2124	■ Littmann® Classic II infant - caribbean blue
32410	2114	■ Littmann® Classic II infant - black
32411	2114R	■ Littmann® Classic II infant - red
32412	2125	■ Littmann® Classic II infant - raspberry
32380	2157	■ Littmann® Classic II infant - raspberry - rainbow finish
32377	2156	■ Littmann® Classic II infant - royal blue
32378	2179	■ Littmann® Classic II infant - orange
32379	2120	■ Littmann® Classic II infant - pearl pink
32375		■ Littmann® Classic II infant - colour on request*
<b>CLASSIC II S.E. ADULT - head Ø 44/32 mm</b>		
32413	2210	■ Littmann® Classic II S.E. - raspberry
32415	2201	■ Littmann® Classic II S.E. - black
32416	2205	■ Littmann® Classic II S.E. - navy blue
32419	2211	■ Littmann® Classic II S.E. - burgundy
32421	2813	■ Littmann® Classic II S.E. - ceil blue
32481	2822	■ Littmann® Classic II S.E. - peach
32483	2817	■ Littmann® Classic II S.E. - bubblegum - pink
<b>CLASSIC II S.E. SPECIAL FINISH - head Ø 44/32 mm</b>		
32470	2218BE	■ Littmann® Classic II S.E. - black edition

## 3M™ LITTMANN® CARDIOLOGY IV STETHOSCOPES



Authorized Distributor



The 3M™ Littmann® Cardiology IV helps you to catch more of the subtle critical sounds, thanks to the improved acoustics and the new design, more versatile than ever.

- better audibility of high-frequency sounds
- tunable diaphragms for hearing both high and low frequency sounds without turning over the chestpiece (pressure sensitive)
- adult and paediatric sides for more versatility
- single-piece diaphragm, easier to attach and clean, because the surface is smooth without crevices
- next generation longer-life tubing
- snap tight soft-sealing eartips.



GIMA code	3M code	3M™ LITTMANN® STETHOSCOPES - length 69 cm
<b>CARDIOLOGY IV - head Ø 43/33 mm</b>		
32606	6152	■ Littmann® Cardiology IV - black
32607	6153	■ Littmann® Cardiology IV - burgundy
32608	6154	■ Littmann® Cardiology IV - navy blue
32609	6155	■ Littmann® Cardiology IV - hunter green
32610	6156	■ Littmann® Cardiology IV - plum
32611	6157	■ Littmann® Cardiology IV - caribbean blue
32612	6158	■ Littmann® Cardiology IV - raspberry
32613	6161	■ Littmann® Cardiology IV - rose pink

GIMA code	3M code	3M™ LITTMANN® STETHOSCOPES - length 69 cm
<b>CARDIOLOGY IV SPECIAL FINISHES - head Ø 43/33 mm</b>		
32631	6162	■ Littmann® Cardiology IV - black - smoke finish
32632	6163	■ Littmann® Cardiology IV - black edition
32633	6164	■ Littmann® Cardiology IV - black - brass finish
32634	6165	■ Littmann® Cardiology IV - black - rainbow finish
32635	6166	■ Littmann® Cardiology IV - plum - smoke finish
32636	6168	■ Littmann® Cardiology IV - navy blue - black finish
32637	6171	■ Littmann® Cardiology IV - turquoise - smoke finish
32638	6178	■ Littmann® Cardiology IV - raspberry - smoke finish
<b>CARDIOLOGY IV MIRROR FINISH - head Ø 43/33 mm</b>		
32646	6169	■ Littmann® Cardiology IV - caribbean blue - mirror fin.
32647	6170	■ Littmann® Cardiology IV - burgundy - mirror finish
32648	6177	■ Littmann® Cardiology IV - black - mirror finish
32649	6179	■ Littmann® Cardiology IV - black/champagne - smoke fin.

## 3M™ LITTMANN® CARDIOLOGY STETHOSCOPES



CARDIOLOGY III



CARDIOLOGY III BLACK EDITION



CARDIOLOGY III COPPER FINISH



MASTER CARDIOLOGY



MASTER CARDIOLOGY BLACK EDITION



CARDIOLOGY TRADITIONAL

GIMA code	3M code	3M™ LITTMANN® STETHOSCOPES - length 69 cm
<b>CARDIOLOGY III - head Ø 43/33 mm</b>		
32371	3138	■ Littmann® Cardiology III - caribbean blue
32372	3148	■ Littmann® Cardiology III - raspberry
32429	3149	■ Littmann® Cardiology III - coral pink
32430	3128	■ Littmann® Cardiology III - black
32431	3129	■ Littmann® Cardiology III - burgundy
32432	3130	■ Littmann® Cardiology III - navy blue
32433	3135	■ Littmann® Cardiology III - plum
32434	3134	■ Littmann® Cardiology III - hunter green
32443	3146	■ Littmann® Cardiology III - light blue
32444	3140	■ Littmann® Cardiology III - red
<b>CARDIOLOGY III SPECIAL EDITION - head Ø 43/33 mm</b>		
32369	3161	■ Littmann® Cardiology III - lime - smoke finish
32472	3131BE	■ Littmann® Cardiology III - black edition
32474	3137CPR	■ Littmann® Cardiology III - chocolate - copper finish
32475	3128BRS	■ Littmann® Cardiology III - black - brass finish
32373	3152RBW	■ Littmann® Cardiology III - black - rainbow finish

GIMA code	3M code	3M™ LITTMANN® STETHOSCOPES - length 69 cm
<b>MASTER CARDIOLOGY - head Ø 51 mm</b>		
32435	2160	■ Littmann® Master Cardiology - black
32436	2163	■ Littmann® Master Cardiology - burgundy
32437	2164	■ Littmann® Master Cardiology - navy blue
32439	2167	■ Littmann® Master Cardiology - plum
32361	2178	■ Littmann® Master Cardiology - caribbean blue
32362		■ Littmann® Master Cardiology - colour on request
<b>MASTER CARDIOLOGY SPECIAL EDITION - head Ø 51 mm</b>		
32360	2176	■ Littmann® Master Cardiology - black smoke ed.
32473	2161	■ Littmann® Master Cardiology - black edition
32363	2183	■ Littmann® Master Cardiology - hunter green brown finish
32359		■ Littmann® Master Cardiology - colour on request
<b>CARDIOLOGY TRADITIONAL</b>		
32330	3141	■ Littmann® Traditional - black
32331	3142	■ Littmann® Traditional - navy blue
32332	3143	■ Littmann® Traditional - burgundy



CARDIOLOGY III



CARDIOLOGY III BLACK EDITION



CARDIOLOGY III COPPER FINISH



MASTER CARDIOLOGY



MASTER CARDIOLOGY BLACK EDITION



CARDIOLOGY TRADITIONAL

# 3M™ LITTMANN® 3100 AND 3200 ELECTRONIC STETHOSCOPES

## ELECTRONIC STETHOSCOPES

3M™ Littmann® Electronic Stethoscope Model 3100 and 3200 exceptional sound capabilities deliver an exceptional auscultation experience. Clinical evidence shows that, it is easier to detect difficult-to-hear heart sounds like S3 gallops and aortic regurgitation murmurs, as well as abnormal lung sounds. Here's why:

### Ambient Noise Reduction Technology

It cancels out, on average, 85% of ambient background noise that can interfere with the auscultation experience, without eliminating critical body sounds.

### Acoustic Seal Eartips and Tubing

They create an excellent acoustic seal. It means a tighter seal from ambient noise entering through tubing and eartip connections.

### State-of-the-Art Sound Sensor

Positioned at the base of the tubing, the sensor brings the sound more naturally to your ears.

### Up to 24X Sound Amplification

Useful for obese



Operates on single AA (alkaline or lithium) battery

Retro-illuminated LCD interface

Ergonomically designed chest piece for easy, one-hand manipulation and patient comfort

## LITTMANN® 3200 ELECTRONIC

Designed to visualize what you are hearing, allow playback when and where convenient, facilitate storage of sounds in patient records or transfer to colleagues for further analysis.

- connects wirelessly to the Bluetooth®
- display and print sounds as phonocardiogram
- play recordings at slow speed
- save patient information
- send as an e-mail attachment



Authorized Distributor

GIMA code	3M code	3M™ LITTMANN® ELECTRONIC STETHOSCOPES
32490	3100BK27	■ Littmann® Electronic 3100 - black
32491	3100BU	■ Littmann® Electronic 3100 - burgundy
32492	3100NB	■ Littmann® Electronic 3100 - navy blue
32495	3200BK27	■ Littmann® Electronic 3200 - black
32496	3200NB	■ Littmann® Electronic 3200 - navy blue
32497	3200BU	■ Littmann® Electronic 3200 - burgundy

# 3M™ LITTMANN® ACCESSORIES

GIMA code	3M code	3M™ LITTMANN® ACCESSORIES
<b>DIAPHRAGM + RETAINING RING - box of 5 pcs</b>		
32449	36572	■ For Cardiology III (small side) - black
51443	36573	■ For Cardiology III (small side) - grey
32450	36556	■ For Classic II S.E., Select, Master classic, Cardio III (large side) - black
32464	36557	■ For Classic II S.E., Select, Master classic, Cardio III (large side) - grey
32452	36554	■ For Master Cardiology - black
32605	36555	■ For Master Cardiology - grey
32453	51185	■ For S.T.C. Cardiology - black
<b>DIAPHRAGM OR RETAINING RINGS</b>		
51450	36550	■ Retaining ring for Pediatric Classic II - black - box of 5
51451	36551	■ Retaining ring for Pediatric Classic II - grey - box of 5
51445	MEMB/E3200	■ Diaphragm for Electronic 3200 - black
32454	MEMB/E3100	■ Diaphragm for Electronic 3100 - dark grey
32478	78808303222	■ Diaphragm for Electronic 3000 - dark grey
51452	36560	■ Diaphragm for Pediatric Classic II - box of 10
<b>NEOPRENE RINGS</b>		
32476	36547	■ Neoprene black ring - infant - box of 5
32455	36569	■ Neoprene grey ring - infant - box of 5
51455	36546	■ Neoprene black ring - pediatric - box of 5
32456	36568	■ Neoprene grey ring - pediatric - box of 5
32459	36544	■ Neoprene black ring - Classic II, Lightweight - box of 10
51456	36545	■ Neoprene grey ring - Classic II - box of 10
<b>EAR TIPS for all models - box of 10 pairs</b>		
32451	37812	■ Ear Tips - grey - soft - large
32465	37809	■ Ear Tips - black - soft - small
32466	37811	■ Ear Tips - black - soft - large
32467	38742	■ Ear Tips - grey - rigid - small
32468	37808	■ Ear Tips - grey - rigid - large
51490	40001	■ Ear Tips - black - small and large
51491	40002	■ Ear Tips - grey - small and large
32460	BLCIP/N	■ Binaural Classic II SE, ped., infant, Select - black
32461	BLCAR/N	■ Binaural Cardiology III and Master Cardiology - black
32462	BLMACL/N	■ Binaural Master Classic, Classic III - black
32469	2170	■ Name tag - black
51494	40007	■ Name tag - black
51495	40008	■ Name tag - grey
<b>2 TUNABLE DIAPHRAGMS AND RIM ASSEMBLY + NON CHILL BELL SLEEVES + EARTIPS</b>		
51460	40003	■ For Cardiology III™ - black - blister
51461	40004	■ For Cardiology III™ - grey - blister
<b>TUNABLE DIAPHRAGM AND RIM ASSEMBLY + NON CHILL BELL SLEEVES + EARTIPS</b>		
51464	40005	■ For Classic II S.E. - black - blister
51465	40006	■ For Classic II S.E. - grey - blister
51466	40020	■ For Lightweight - black - blister
<b>TUNABLE DIAPHRAGM + RIM ASSEMBLY + EARTIPS</b>		
51470	40011	■ For Master Cardiology - black - blister
51471	40018	■ For Master Cardiology - grey - blister
51472	40019	■ For Cardiology S.T.C. - black - blister
51473	40022	■ For Master Classic™ - black - blister
<b>TUNABLE DIAPHRAGM + 2 RIMS ASSEMBLY</b>		
51477	40012	■ For Classic II™ - Paediatric - black - blister
51478	40013	■ For Classic II™ - Infant - black - blister
<b>2 TUNABLE DIAPHRAGMS + RIM ASSEMBLY + EARTIPS</b>		
51482	40016	■ For Classic III™ - black - blister
51483	40017	■ For Classic III™ - grey - blister



Authorized Distributor



## YTON ANEROID SPHYGMOMANOMETERS

### YTON ANEROID SPHYGMOMANOMETERS

Economic sphygmomanometers with nylon cuff with velcro closure, reliable manometer with clip to be fixed on the cuff. Scale 0-300 mmHg. Air release at closed tap max 4 mmHg/minute. Manual setting of deflation possible up to 2/3 mmHg/sec. From 260 mmHg to 15 mmHg max deflation time 10 sec. Scale graduated every 2 mmHg.

Floating zero (the pointer has no stop point but swings freely), nylon velcro cuff, latex bulb with chromium plated valve. Chromium-plated air tap with air release regulation by screw valve. Supplied with a simulated-leather soft pouch with zip in a carton box. Available in 5 versions: standard, with one piece cuff, latex free, with incorporated stethoscopes or kit (sphygmomanometer+stethoscope). Multilanguage box and manual: GB, FR, IT, ES, PT, DE, GR, Arabic.

GIMA code	YTON SPHYGMOMANOMETERS	
32720	YTON - black cuff	■
32692	YTON - one piece cuff	■
32704	YTON latex-free - blue cuff	■
32703	YTON - with incorporated - stethoscope - black cuff	■
32693	YTON KIT - sphygmomanometer + stethoscope	■
32701	YTON MANOMETER - spare	■



**32703**  
Yton with incorporated Stethoscope



**32720**  
Yton sphygmomanometer



ONE PIECE CUFF  
LATEX FREE

CE 0476

32692



CE 0476

LATEX FREE

32704



INCORPORATED STETHOSCOPE

CE 0476

32703



LATEX FREE

KIT STETHOSCOPE + SPHYGMO

CE 0476

32693

## YTON DIGITAL SPHYGMO

• **32722 YTON DIGITAL SPHYGMO**  
Semi-automatic digital sphygmomanometer with manual inflation and automatic deflation through manual valve. Light: only 50 g, one third of a normal blood pressure monitor. A large 9 digits LCD display shows systolic/diastolic/pulse rate simultaneously, and store 90 memories. Range: 40-260 mmHg. Pulse: 40-160 minute. Power supply: 1 x AAA battery. Multilanguage box: GB, FR, IT, ES, PT, DE, GR, Arabic. Manual: GB, IT

Digital Yton sphygmomanometer



CE 0476

32722

# SPHYGMOMANOMETERS WITH GAUGE ON THE CUFF

CE 0051

32724

CE 0051

CE 0476



- **32724 BERLIN SPHYGMO - velcro cuff**  
High quality sphygmomanometer with gauge mounted on cuff:  
- high reliable manometer with extra large dial Ø 65 mm  
- top quality and resistant linen cuff with simulated leather support and velcro closure  
- extra large PVC bulb, 9x5 cm, latex free  
Made in Italy - German manometer

- **32723 NEW EXACTOPHON SPHYGMO - pull-on strap cuff**  
GIMA quality and reliability in a stylish and long-life sphygmomanometer. EXACTOPHON has a reliable manometer fixed on a simulated leather support, on a highly resistant linen pull-on straps cuff. Supplied in a nice carrying case and box. Made in Italy: GIMA.
- **32805 EXACTOPHON BLADDER - spare**
- **32806 EXACTOPHON CUFF - spare**

- **32719 GIMATONO - latex free**  
Economic sphygmo with chrome-plated manometer fixed on the cuff, provided with a rubber protective ring. Nylon cuff with simulated-leather support. Two tubes adult size latex free TPU bladder, with standard latex free PVC bulb. Supplied in nylon bag and cardboard box. Made in P.R.C.

# SHOCK RESISTANT SPHYGMO MINOR 2 SPHYGMO - 2 TUBES

CE 0476

ISO 81060 STANDARD

3 YEARS WARRANTY



- **32702 SHOCK RESISTANT SPHYGMO - nylon-cuff**  
High quality, shock resistant sphygmomanometer matching the ISO 81060 standard.  
**One piece design with damped system manometer**  
Creative design with a new structure that fixes all parts together closely to make it more steadier. The damped system absorbs impacts.  
**Other features**  
- large dial Ø 55 mm easy to read  
- high precision air-release valve, provides precise rate adjustment and quick deflation  
- adult nylon cuff with latex-free bladder  
- soft bulb for fast inflation.  
Multilanguage box and manual: GB, FR, IT, ES, PT, DE.



- **32714 MINOR 2 SPHYGMO - 2 tubes - black nylon velcro cuff**
- **32713 MINOR 2 SPHYGMO - 2 tubes - green cotton hook cuff**  
High quality sphygmomanometer with traditional design and modern features.  
- high precision manometer, adjustable by turning a screwdriver, for perfect calibration any time  
- 2 tubes system for quick inflation  
- Available with washable coated fabric velcro cuff or cotton hook cuff



## SIRIO SPHYGMO AND 3 MULTICUFF KIT WITH BAG

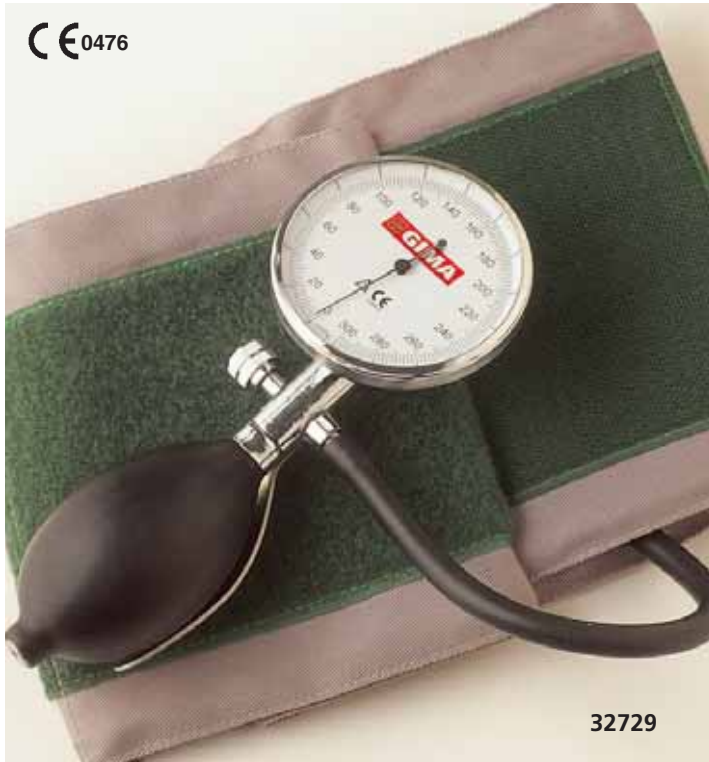

• **32729 SIRIO SPHYGMO - adult grey/green cuff**  
 Classic sphygmomanometer with fabric cuff with velcro closure (green/grey colour). Reliable large dial manometer for easy readings, fixed on bulb. Scale 0-300 mmHg, graduated every 2 mmHg. Supplied in carrying case and box, with 4 languages user manual (English, Spanish, French, Italian).



• **32705 SIRIO PEDIATRIC KIT - sphygmo with 3 pediatric cuffs**  
 Sirio with 3 pediatric cuffs: minicuff (32812) 4 months - 3years, minicuff (32813) 3-7 years, minicuff (32814) 7-10 years in a nylon bag.  
 • **27177 SIRIO MULTICUFF PEDIATRIC BAG - empty**



• **32706 SIRIO KIT 3 - sphygmo with 3 one piece cuffs**  
 Sirio with 3 one piece cuffs: child (32910), adult (32911) and adult large (32912) in a nylon bag.  
 • **27178 SIRIO MULTICUFF BAG 3 - empty**



• **32707 SIRIO KIT 5 - sphygmo with 5 cuffs**  
 Sirio with 5 cuffs: infant cuff (32886), child cuff (32888), adult cuff (32830), adult large cuff (32834) thigh cuff (32837) in a nylon bag.  
 • **27179 SIRIO MULTICUFF BAG 5 - empty**



## LONDON: PROFESSIONAL SPHYGMO



• **32725 LONDON SPHYGMO - adult - black cuff**  
 • **32726 LONDON SPHYGMO - adult - red cuff**  
 Professional, stylish, reliable and lightweight sphygmomanometer with ABS manometer, integral PVC bulb, high quality precision mechanism, velcro closure calibrated nylon cuff and one tube TPU bladder. Dial Ø 55 mm, with specially designed eye-catching colour printing and easy to read. Special outer ring protects the manometer from shocks



and the glass from scratches. Supplied in a nice colour co-ordinated carrying bag and box. With multilingual box and user manual: GB, FR, IT, ES, DE, PT, GR. Latex free.



## TOKYO AUTOMATIC

• **32735 TOKYO SPHYGMO - adult - black cuff**  
Professional sphygmomanometer with large Ø 65 mm dial and **button type air release valve**. ABS light plastic case, and extra shock-proof ring for long durability.

360° rotary handle.  
Supplied with black nylon calibrated cuff with D-ring, black 1-tube PVC, latex free bladder and black, latex free PVC bulb in a nylon carrying bag and cardboard box.  
Multilanguage box and manual:  
GB, FR, IT, ES, DE, PT, GR, Arab.



CE 0476

For rapid (push) or gradual (screw) deflation



Press the button, rapid deflation



Screw the button, gradual deflation

## ROMA SPHYGMOMANOMETERS - 4 DIFFERENT MODELS



CE 0476

32727

**32709** Pediatric



**32734** 2 tubes



**32728** Fluorescent dial plate



Classic, lightweight, reliable palm model aneroid sphygmo with certified manometer ABS housing, integral PVC bulb and air release valve for one-hand use, provided with handle, blue nylon, velcro closure, calibrated cuff and 1 tube TPU bladder.

Easy to read: large dial Ø 60 mm, with rubber protective ring.

Supplied in a nice nylon carrying bag with external velcro pocket and cardboard box. Latex free.

- **32727 ROMA SPHYGMO - adult - 1 tube**
  - **32734 ROMA SPHYGMO - adult - 2 tubes**
  - **32709 ROMA SPHYGMO - pediatry - 1 tube**
  - **32728 ROMA SPHYGMO - adult - fluorescent - 1 tube**
- Same as 32727 but with special fluorescent dial plate to allow easy reading even in dark places.  
Suitable for emergency.
- **32856 PVC RIBBED BULB**
  - **32857 PVC PROTECTIVE RING**



## ROMA MULTICUFFS KIT



CE 0476

32738

• **32738 ROMA KIT - Sphygmo with 3 cuffs**  
Same as code 32727 but supplied with 3 cuffs: one pediatric (35x11 cm), one adult (49x15 cm) and one adult large (62x17.5 cm).  
Latex free.

## EMERGENCY MULTICUFF KIT

• **32771 EMERGENCY SPHYGMO KIT - 5 cuffs**  
Palm type sphygmomanometer with orange silicone shockproof ring and orange cup of air-release valve. PVC tube and 1 tube TPU bladder.  
Supplied in a plastic carrying case with 5 cuffs: XS infant (13-19 cm), S child (18.4-26.7 cm), M adult (25.4-40.6 cm), L adult large (33.3-51 cm), XL thigh (40.6-66 cm)



32771



CE 0123

# CUFFS ASSORTMENT FROM NEWBORN TO OBESE



Nylon cuff with velcro fastening, EPDM syntetic rubber bladder, latex free

MINI CUFFS grey/green - nylon				
1 tube	2 tubes	Model	Size cm	
32810	32820	Premature	16xh 5	
32811	32821	Up to 3 months	23xh 5	
32812	32822	4 months to 3 years	29xh 7	
32813	32823	3-7 years	33xh 9	
32814	32824	7-10 years	40xh 11	
32816	32826	32810-14, 32820-24		Set 5 pieces



Calibrated nylon cuffs with TPU bladder and PVC tube

CALIBRATED CUFFS - latex free - nylon				
1 tube	2 tubes	Model	Size cm	Colour
-	32839	Pediatric	35x11	Black
32846	32847	Pediatric	35x11	Blue
32842	32843	Adult	49x15	Blue
32844	-	Adult	49x15	Red
32845	32850	Adult	49x15	Black
32848	32849	Adult large	62x17.5	Blue
-	32841	Adult large	62x17.5	Black



CUFFS grey/black - nylon - TPU bladder - velcro fastening				
1 tube	2 tubes	Model	Arm circumference	Size cm
32886	32887	Infant	13 to 19 cm	7.5x26
32888	32889	Child	18.4 to 26 cm	11x34
32830	32832	Adult	25 to 40 cm	52x15
32834	32835	Adult large	35 to 50 cm	61x17.5
32837	32838	Thigh	41 to 66 cm	82x21

ADULT CUFFS grey/green - cotton - TPU bladder - velcro fastening				
1 tube	2 tubes	Model	Arm circumference	Size cm
32829	-	Adult		53x14.5

One tube cuff for Ranger, Sirio, London, Boston, Roma 1T, Tokyo, Ri-san, Precisa, Minimus.  
Two tubes cuff for Minor, Diplomat, Yton line, Roma 2T, Dallas, Big Ben, Empire.



- Bladderless nylon cuffs
- reusable above 10,000 times
  - washable up to 60°C
  - disinfectable with alcohol/ethanol
  - ideal to prevent cross-contaminations
  - soft surface for a pleasurable feeling on the skin
  - tested according to ISO 105 E01

BLADDERLESS ONE PIECE CUFF - latex free				
1 tube	2 tubes	Model	Size	Arm circumference
32910	32913	children	10x34 cm	19 to 27 cm
32911	32914	adult	14.5x54 cm	26 to 41 cm
32912	32915	adult large	16x63 cm	34.3 to 51 cm

# SPHYGMOMANOMETERS SPARE PARTS AND ACCESSORIES



GIMA code	SPHYGMOMANOMETERS SPARE PARTS	Minimum order
32865	Coiled tubing - black (42-45 spirals) - 48 cm	10 pcs.
32808	Nylon velcro cuff (no bladder) 54 x15 cm	10 pcs.
32874	1 tube Bladder	10 pcs.
32875	2 tubes Bladder	10 pcs.
32876	1 tube + 1 hole Gimatono Bladder	10 pcs.
32880	Vertical glass tube	10 pcs.
32870	Male-Female metal connector	box 10
32871	Screw Type metal connector	box 10
32872	Bayonet Type metal connector	box 10
32873	Plastic connector	box 100



GIMA code	SPHYGMOMANOMETERS SPARE PARTS	Minimum order
32854	Yota PVC bulb - black - latex free	10 pcs.
32851	Yota PVC bulb - green	10 pcs.
32855	Yota latex bulb - black	10 pcs.
32860	Superior PVC bulb - green - latex free*	10 pcs.
32859	Superior PVC bulb - black*	10 pcs.
32852	Yota chrome-plated air release valve	10 pcs.
32861	Superior chrome plated air valve	10 pcs.
32853	Yota inflation system	10 pcs.
32862	Superior inflation system - latex free*	10 pcs.
32863	Deluxe inflation system	10 pcs.

\*Made in Germany



## BABYPHON® RIESTER PEDIATRIC SPHYGMO



- **32710 BABYPHON® PEDIATRIC SPHYGMO with 3 cuffs**
- Palm pediatric sphygmomanometer with 3 cuffs
- fast inflation of the cuff due to ergonomic spoon-shaped stainless steel handle
- easy reading metal manometer with aluminium scale Ø 49 mm (19.29 inch)
- lifelong precision due to almost non-aging precision movement with specially tempered copper-beryllium diaphragm for pressure-loading capacity up to 600 mmHg
- linear scale up to 300 mmHg, ±3 mmHg
- bear imprint on the cuffs
- Supplied with 3 pediatric cuffs (child, infant and new-born in a padded nylon zipper case).
- Newborn: size 15.5x5 cm - circumference 5-8 cm
- Infant: size 23x7.5 cm - circumference 8-13 cm
- Baby: size 35.5x10 cm - circumference 13-17 cm



## PRESS<sup>SAN</sup>® HYGIENIC PROTECTION OF SPHYGMOMANOMETER

- **32858 PRESS<sup>SAN</sup>® HYGIENIC PROTECTION OF SPHYGMO - box of 10**

A practical hygienic accessory for the sphygmomanometer to protect patient's skin whilst measuring the blood pressure. Made of a white non-woven fabric. Ensures patient's comfort and hygiene. Can fit any kind of sphygmomanometer or pressure holster.



32858

## RIESTER ORIGINAL CUFFS - LATEX FREE

GIMA code	RIESTER code	RIESTER CUFFS 1 TUBE	Colour	Size cm	Circumference cm	Compatibility
49811	129	Child velcro cuff	light blue	34.5x10	13-17	Minimus II <sup>®</sup> , Precisa, Ri-san, R1 Shock proof, E-Mega <sup>®</sup> , Baby phon <sup>®</sup>
49812	107	Adult velcro cuff	black	54.5x14.5	24-34	
49813	122	Adult/large velcro cuff	black	70x15	34-44	
<b>ONE PIECE RIESTER CUFFS 1 TUBE</b> washable at 60°C and disinfectable in liquid reusable up to 10,000 times. ISO 105 E01 tested						
49816	154	Child one-piece cuff	dark green	35.5x10	13-17	Same as cuffs 1 tube
49817	150	Adult one-piece cuff	dark green	54.5x14.5	24-32	
<b>RIESTER CUFFS 2 TUBES</b>						
49821	130	Child velcro cuff	light blue	35.5x10	13-17	Big Ben
49822	108	Adult velcro cuff	black	54.5x14.5	24-32	

\*Metal valve not included with spare cuff, can use valve from old cuff



## HEINE ORIGINAL CUFFS - LATEX FREE

GIMA code	HEINE code	HEINE CUFFS 1 TUBE	Colour	Size cm	Circumference cm	Compatibility
49801	M-000-09-702	Child - 2	grey	10x34	13-20	All Heine 1 tube
49802	M-000-09-704	Adult small - 3	grey	14x53	20-29	
49803	M-000-09-619	Adult - 4	grey	14x58	29-41	
49804	M-000-09-706	Adult large - 5	grey	17x70	35-47	

Water resistant washable material



## ERKA ORIGINAL GREEN SUPERB CUFFS - LATEX, PVC, DEHP FREE

Made in durable patented German PU material, perfect for cleaning and disinfection

GIMA code	ERKA code	ERKA CUFFS 1 TUBE - grey	Size cm	Circumference cm	Compatibility
32895	025-28493	Infant	21.5x6.6	10-15	Switch and Kobold
32896	025-27493	Baby	30.3x9.1	14-21.5	
32891	025-26493	Child	40x11.6	20.5-28	
32892	025-20493	Adult	47x14.3	27-35	
32893	025-24493	Adult large	56x17.5	34-43	
32894	025-29493	Thigh	75x21.5	42-54	
<b>ERKA CUFFS 2 TUBES - green</b>					
32898	025-26481	Child	40x11.6	20.5-28	Vario
32899	025-20481	Adult	47x14.3	27-35	
32900	025-24481	Adult large	56x17.5	34-43	
<b>ERKA TWIN TUBE CUFFS - green</b>					
32877	025-26482	Child	40x11.6	20.5-28	Perfect Aneroid and Profi
32878	025-20482	Adult	47x14.3	27-35	
32879	025-24482	Adult large	56x17.5	34-43	

32891



Twin tube

# RIESTER ANEROID SPHYGMO - MADE IN GERMANY



Sturdy and light aluminium casing, corrosion protected

High-polished manometer surface, easy to disinfect

**Riester**  
CE 0124



Large dial 63 mm

Non-resistant opening of air release valve ensures precise and comfortable operation

**SHOCK PROOF**

Shock protecting polycarbonate case

Spoon-shaped handle made of stainless-steel

Fast, ergonomic inflation due to optimized bulb design with integrated spoon

32716

**Riester**  
CE 0124

**Riester**  
CE 0124

• **32686 SANAPHON SPHYGMO with integrated stethoscope**  
A classic palm-style sphygmomanometer for precise self-measurement including stethoscope. Sanaphon® guarantees exact measurement values even for patients with heart rhythm disturbances.  
- maximum error tolerance  $\pm 3$  mmHg  
- supplied in zipper bag

• **32687 E-MEGA SPHYGMO**  
With disinfectable latex free one-piece cuff.  
- fast inflation of the cuff due to new ergonomic spoon design  
- lifelong precision due to almost non-aging precision movement, with specially tempered copper-beryllium diaphragm for pressure-loading capacity up to 600 mmHg  
- comfort - air release valve, wearfree, with fine adjustment

• **32716 R1 SHOCK PROOF SPHYGMO**  
Exact precision that lasts a lifetime. Made in Germany, 5 years warranty on calibration.  
- shock-proof up to a falling height of 120 cm  
- scale:  $\varnothing$  52 mm black with red fluorescent pointer  
- valve base and air duct with metal precision valve  
- two-component ABS casing  
- metal threaded tube connection at the top of the casing for fast cuff exchange and ergonomical operation.  
- maximum error tolerance of  $\pm 3$  mmHg  
- weight: 173 g  
- supplied in zipper bag  
- latex free

**Riester**  
CE 0124  
BHS VALIDATION

Easily readable scale  $\varnothing$  64, from 0 to 300 mmHg,  $\pm 3$  mmHg

32715

Precision air release valve with fine adjustment and wear-free

Suitable for right or left handed users

• **32715 RI-SAN® SPHYGMO**  
High quality palm-style sphygmomanometer with ergonomic design. Air release valve conveniently regulated by finger-tip control.  
- calibrated nylon cuff with velcro  
- latex-free bulb for pumping up the cuff  
- tube connection at the top of pressure gauge for unhindered blood pressure measurement  
- microfilter protects air release valve and measuring system  
- specially tempered copper-beryllium diaphragm almost non-aging  
- the precision movement guarantees reliable measurement  
- diaphragm can be pressurized up to 600 mmHg without decalibrating the sphygmo.

**Riester**  
CE 0124  
BHS VALIDATION

Easily readable scale  $\varnothing$  64, from 0 to 300 mmHg,  $\pm 3$  mmHg

32717

Precision air release valve with fine adjustment and wear-free

• **32717 PRECISA® N SPHYGMO**  
A typical Riester quality product. In metal with aluminium housing and single tube - plug-in connection.  
- calibrated nylon cuff with velcro.  
- latex-free bulb, and metal valve base  
- ergonomic grip of stainless steel  
- microfilter protects air release valve and measuring system  
- specially tempered copper-beryllium diaphragm, with precision movement and almost non-aging  
- diaphragm pressure-loading capacity up to 600 mmHg  
- scale, from 0 to 300 mmHg,  $\pm 3$  mmHg  
Supplied with synthetic leather bag.

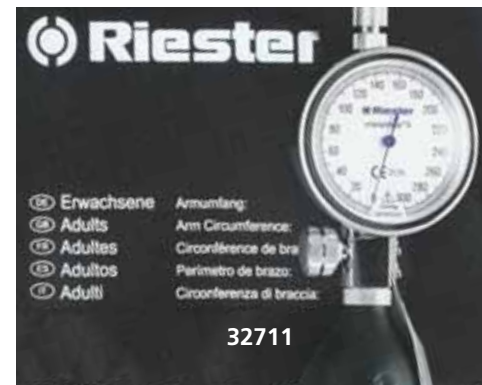

**Riester**  
CE 0124  
BHS VALIDATION

• **32711 MINIMUS® II SPHYGMO**  
MINIMUS® is a reliable, durable and elegant palm model aneroid chrome-plated manometer with integral latex-free bulb and air release valve for one hand use, provided with a stainless steel handle, Luer Lock connection, calibrated black nylon velcro closure cuff and 1 tube bladder. Supplied in a nice synthetic leather bag.

## KOBOLD SPHYGMOMANOMETER BY ERKA

- 32691 BLACK KOBOLD with gray cuff - 223.20493
  - 32695 GREY KOBOLD SET with 3 ped. "Superb" cuffs - 227.71.393
  - 32696 GREY KOBOLD SET with 6 "Superb" cuffs - 227.71.195
- Elegant and compact, single tube sphygmomanometer for frequent use in clinic and consulting room. Precision manometer, anodised aluminium Ø 48 mm. Sensitive adjustable air reduction valve, high quality chrome finish. Scale: 300 mmHg, 2 mm scale division. New technology with air intake via the manometer capsule in the specially tempered copper-beryllium membrane. Codes 32693, 32695, 32696 are latex free. Made in Germany.

### ERKA "SUPERB" GREEN CUFFS

All ERKA Green cuff products are PVC, demp and latex-free, every one is individually tested prior to delivery and guaranteed for 50,000 inflation cycles. They are equipped with clearly marked size and positioning features for the most accurate possible measurements. The soft, easy to disinfect, biocompatible materials ensure maximum patient comfort. Conform to ANSI/AAMI SP10 standard

- 32891 PEDIATRIC "SUPERB" CUFF 1 TUBE 20.5 - 28 cm - grey
- 32892 ADULT "SUPERB" CUFF 1 TUBE 27-35 cm - grey - spare



32691

**ERKA.**



32696 CE 0124

Includes 6 cuffs for below indicated circumferences of upper arm

Thigh 42-54 cm    Adult large 34-43 cm    Adult 27-35 cm    Child 20.5-28 cm    Baby 13-20 cm    Infant 10-15 cm



CE 0124

Child 20.5-28 cm    Baby 14-21.5 cm    Infant 10-15 cm

32695

## PERFECT ANEROID

## ERKA SWITCH

## ERKA SWITCH SIMPLEX



CE 0124

Erka Superb Green cuff. Latex, PVC and DEHP free

32688

**ERKA.**

- 32688 ERKA PERFECT - 201.204.82 dial Ø 48 mm - 2 tubes green
- Sphygmomanometer with screw valve for sensitive adjustments, velcro cuff and case.
- manometer housing brass chromed plated
  - membrane-protection 2-tube technology
  - measuring range 0-300 mmHg ±1%
- Made in Germany. 3 year warranty.
- 32877 PEDIATRIC "SUPERB" CUFF TWIN TUBE 20.5 - 28 cm - grey
  - 32878 ADULT "SUPERB" CUFF TWIN TUBE 27-35 cm - grey - spare



CE 0124

Erka Superb Green cuff. Latex, PVC and DEHP free

32698

**ERKA.**

- 32698 ERKA SWITCH 2.0 CONFORT - dial Ø 56 mm - 1 tube grey - 293.204.93
- It offers outstanding ergonomics and simple adaptation for left and right-handle users. It is manufactured from shock-resistant polycarbonate and has passed the shock test according to AAMI SP9. The sight glass is chemically stable and unbreakable. The brass valve screw works smoothly and is adjustable to exact settings. MR compatibility. Measuring range 0-300 mmHg ±1%. Supplied with pouch. Made in Germany. 4 year warranty hand held, 2 year manometer.
- 32891 PEDIATRIC "SUPERB" CUFF 1 TUBE 20.5 - 28 cm - grey
  - 32892 ADULT "SUPERB" CUFF 1 TUBE 27-35 cm - grey - spare



CE 0124

32697

**ERKA.**

- 32697 ERKA SWITCH SIMPLEX - dial Ø 56 mm - twin tubes grey - 294.408.94
- It is manufactured from shock-resistant polycarbonate and has passed the shock test according to AAMI SP9. The sight glass is chemically stable and unbreakable. The brass valve screw works smoothly and is adjustable to exact settings. Measuring range 0-300 mmHg ±1%. Black velcro cuff. Supplied with pouch. Magnetic Resonance (MR) compatibility. Made in Germany. 2 year warranty.

**BOSTON SPHYGMO G5® AND G7® HEINE SPHYGMO**



• 32731 BOSTON SPHYGMO - adult - black cuff

Strong durable and elegant palm model aneroid metal zinc-alloy manometer with integral PVC bulb and air release valve for one hand use, provided with a special left and right hand adjustable handle, nylon velcro closure calibrated cuff and 1 tube TPU bladder. Easy to read: large dial Ø 60 mm. Unique push button air release valve offers precise mini-deflation. Special PVC patented ribber bulb. Latex free. Supplied with a nice nylon carrying bag. Multilanguage box and manual: GB, FR, IT, ES, PT, DE, GR, Arab.



**10 YEARS WARRANTY**

**5 YEARS WARRANTY**



The inflator spoon can be set for left and right-handed users.

- 32737 GAMMA "G5®" HEINE SPHYGMO - plastic manometer - M-000.09.230
- 32741 GAMMA "G5®" HEINE SPHYGMO - plastic manometer Same as 32737, but supplied without carrying bag.
- 32739 GAMMA "G7®" HEINE SPHYGMO - aluminium manometer - M-000.09.232

With the new latex free G5® and G7® Heine, GIMA offers an aneroid sphygmomanometer of the highest quality of design and function with unequalled value for the money. A modern, functional design combined with exceptional precision of measurement and durability make Heine G5® and G7® ideal for long-term use in clinic and practice environments.

- latex-free
  - exceptionally-strong housing construction with triple-mounted, shockproof movement.
  - impact-resistant housing crafted in special, shock-absorbing materials incorporate the latest advances in injection-moulding technology.
  - a microfilter protects the valve and movement.
  - oversized inflator speeds up cuff inflation.
- Made in Germany. 5 years warranty (G5), 10 years warranty (G7).



G5® and G7® (excluding 32741) are supplied with high quality HEINE carrying bag.

**WELCH ALLYN® DURA SHOCK™ DS55 SPHYGMOMANOMETER**

10 years calibration warranty



- 32700 DURA SHOCK DS55 SILVER LINE - DS-5501-189
- Welch Allyn's DS55 sphygmomanometer incorporating shock-resistant DuraShock technology offers practical benefits compared to traditional aneroid sphygmomanometers. This is especially beneficial in busy medical environments where equipment needs to be as robust as possible. With DuraShock Technology, Welch Allyn B.P. gauges:
- remain in calibration longer than traditional aneroid B.P. gauges, providing you with more accurate readings.
  - do not need to be replaced as often as traditional aneroid B.P. gauges, giving you a lower lifetime cost.
  - have the only gauge capable of passing AAMI's shock-resistant specification of surviving a 76 cm drop onto a hard surface and remaining in calibration.



**How DuraShock technology works**

In traditional aneroid sphygmomanometer design, several delicate gears and springs convert and amplify vertical movement of the pinion to rotational movement to turn the pointer. The DuraShock gear-free design uses a single helix spring to directly convert the vertical movement of the pinion to rotation of the pointer without the use of a multi-step gear arrangement. By creating a gear-free design, the Welch Allyn Durashock has fewer moving parts providing a gauge which is shock resistant and lighter than traditional gauges. Until now, a dropped sphygmomanometer required recalibration or replacement. The DuraShock can fall 76 cm onto a hard surface and still remain accurate. It is the only gauge capable of meeting the AAMI Shock Resistant specification.

# LCD DISPLAY, MERCURY-FREE SPHYGMOMANOMETERS

## MERCURY FREE SPHYGMOMANOMETERS

A new technology of LCD display mercury-free sphygmomanometers alternative to the mercury column.

Precise results and support to global environment saving pollution. Manual inflation and air release.

Two measuring methods: button AUSC (Auscultation), for use with a stethoscope, button OSCI (Oscillometric), to get the result automatically, without need of a stethoscope, just inflate the cuff not less than 180 mmHg.

Suitable for pediatric use with auscultation method only (need 32825).

Supplied with adult cuff

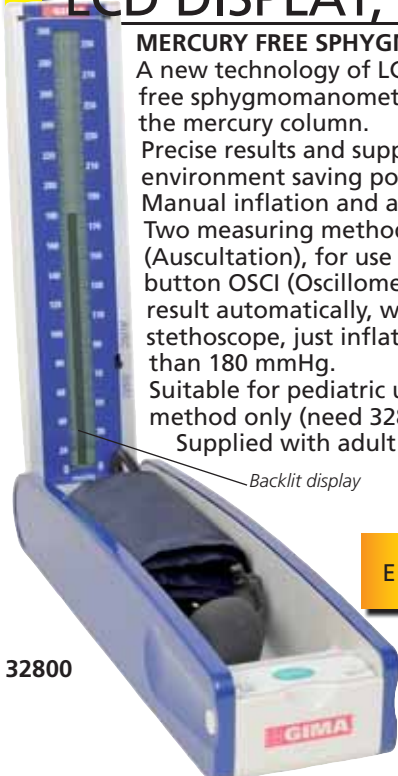

32800

Backlit display



**GREEN AND ENVIRONMENTAL PROTECTION**



32801

## AND PROFESSIONAL MERCURY FREE SPHYGMOMANOMETERS

Professional highly advanced digital blood pressure monitor alternative to the mercury column

- auscultatory blood pressure measurement
- digital readout for pulse rate

- cuff holder and grip for carrying
- durable and chemical resistant body
- full ABS housing lightweight body
- adjustable display column for easier analysis of results
- anti-glare display minimizes reflected light



32775



Supplied with adult cuff 22-32 cm

32776



- 32800 GREEN MERCURY FREE SPHYGMO - desk
- 32801 GREEN MERCURY FREE SPHYGMO - on trolley with basket
- 32825 PEDIATRIC CUFF 16-22 cm - optional
- 32827 ADULT CUFF 22-32 cm - spare
- 32828 LARGE ADULT CUFF 32-45 cm - optional

### TECHNICAL SPECIFICATIONS (32800, 32801)

Size: 360x96x66 mm (32800) Power supply: battery  
Measuring range: 20-280 mmHg Accuracy: pressure: ±3 mmHg

- 32758 UM-101 MERCURY FREE SPHYGMOMANOMETER - desk
- 32775 UM-102A MERCURY FREE SPHYGMOMANOMETER - desk
- 32776 UM-102B MERCURY FREE SPHYGMOMANOMETER - trolley

### TECHNICAL SPECIFICATIONS

Size: 360x96x66 mm (32775)  
Measuring range - pressure: 0-300 mmHg ±3 mmHg  
- pulse: 40-180 beats/minute ±5% (32775-6)  
30-200 beats/minute ±5% (32758)  
Power supply: 2x1.5V AA alkaline batteries

# MERCURIAL SPHYGMOMANOMETERS: DESK, WALL, TROLLEY

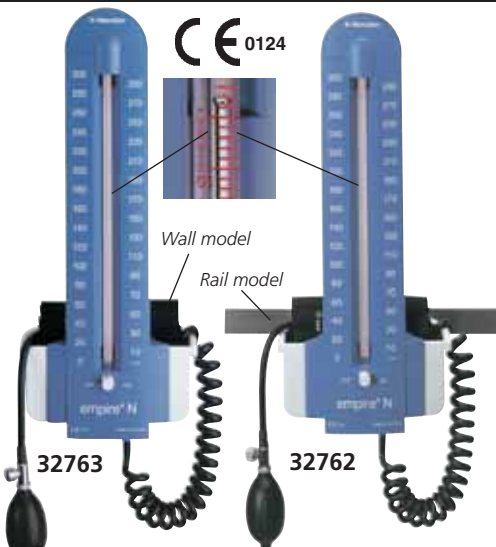

32763

32762



Wall model

Rail model



32759



32760  
YTON



32769

Height adjustable from 110 to 150 cm

5 castors trolley

Metal trolley

- 32762 EMPIRE - anaesthetic model (rail)  
Rail and clamp not included.
- 32766 RAIL clamp (for code 32762)
- 32763 EMPIRE - wall



Attractive mercury sphygmomanometers. Housing made of resistant engineering plastic, including a basket. Precision glass tube with inner diameter of 4.2 mm ±0.2 mm. Face plate with easy-to-read graduated scale. Maximum reading 300 mmHg ±3 mmHg. Mercury lock. Basket for convenient accessory storage. Coiled tubing extensible to 3 m. With latex free bulb and chromed-plated air release valve.

Made in Germany

- 32883 GLASS TUBE - spare for EMPIRE

- 32759 YTON MERCURIAL SPHYGMO - pediatric

Desk mercurial sphygmomanometer in aluminium painted case with self locking, with adult nylon cuff with velcro and metal D-ring. Range 0-300 mmHg. PVC latex free.

- 32760 YTON MERCURIAL SPHYGMO - wall
- 32769 YTON MERCURIAL SPHYGMO - trolley - made in China Mercury sphygmomanometers with velcro cuff (2 tubes) and storage compartment. 0-300 mmHg. PVC latex free.
- 32764 KENZ MERCURIAL SPHYGMO - trolley Same as 32769, made in Japan.

## ERKA VARIO DESK WALL AND MOBILE - MADE IN GERMANY

- 32671 VARIO - desk - adult cuff - 285.20.481
  - 32672 VARIO - wall - adult cuff - 288.20.481+295.00.003
  - 32673 VARIO - trolley Ø 50 cm - adult cuff+288.20.481+995.00.003
- Superior quality product, made in Germany, for use in consulting rooms or hospital. The Vario model consists of a high precision manometer in a high quality ABS housing with an integrated fastening spigot for individual variable swivelling, a big cuff basket in white powder coated sheet steel, a bulb holder and spiral tubing with bulb and air release valve. This high quality chromium-plated valve makes sensitive adjustments easy. The 150 mm scale is equipped with a mirrored exterior ring and non-reflective manometer glass.
- 32898 PEDIATRIC "SUPERB" CUFF 2 TUBES - 20.5-28 cm (arm circumference)
  - 32899 ADULT "SUPERB" CUFF 2 TUBES - 27-35 cm (arm circumference) - spare
  - 32900 LARGE "SUPERB" CUFF 2 TUBES - 34-43 cm (arm circumference)



### TECHNICAL SPECIFICATIONS

Height with basket:	260 mm (32672-3)
Width with basket:	180 mm (32672-3)
Depth with basket:	120 mm (32672-3)
Graduation:	0-300 mmHg ±3 mmHg
Weight with basket:	1,350 g
Height of trolley:	830-1,360 mm (adjustable)
Tubing system Ø:	18-25 mm
Swivel range:	up to 60 deg°

32671

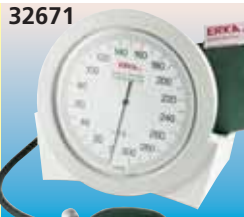

## RIESTER BIG BEN® - MADE IN GERMANY

- 32742 RIESTER BIG BEN® - rail (clamp code 32766 and rail not included)
- 32743 RIESTER BIG BEN® - wall
- 32746 RIESTER BIG BEN® - trolley Ø 54 cm

Aneroid sphygmomanometer, made of resistant plastic, with large dial (147 mm) and white pointer on black dial plate for easy-to-read measurements from 0 mmHg to 300 mmHg. Basket on back for cuff storage after use. Velcro-closure black cuff 2 tubes, and long coil tubing. Latex free.

Quality product: made in Germany.

- 32766 RAIL CLAMP  
Universal clamp (for code 32742) for any rail.

Made in Germany



32743

CE 0124

Riester

Plastic basket on back for cuff storage



32766



CE 0124

New trolley Ø 54 cm

## OMRON PROFESSIONAL B.P. MONITOR

- 32936 OMRON DIGITAL AUTOMATIC B.P. MONITOR HEM-907

Professional B.P. monitor designed for clinical use in professional settings.

- gold standard accuracy
- validated according to international protocols:

1- Association for the Advancement of Medical Instrumentation (AAMI)

- 2- European Society of Hypertension
- International Protocol (ESH - IP)
- intellisense technology
- irregular pulse indicator
- 3 modes of operation: single mode, average mode, auscultation (manual mode).



Supplied with battery pack, adult cuff (22-32 cm), AC adapter.

Made in Japan.

- 32937 ADULT LARGE CUFF 32-42 cm
- 32939 TROLLEY FOR OMRON HEM-907

### TECHNICAL SPECIFICATIONS

Method:	Oscillometric
Measurement range:	pressure: 0-299 mmHg ± 3 mmHg or 2% pulse rate: 30-199 beats/min ± 5% of reading
Inflation:	automatic inflation with pumping
Deflation:	automatic deflation by electromagnetic control valve
Air release:	automatic rapid air release by electromagnetic control valve
Pressure detection:	electrostatic capacity semi-conductor pressure sensor
Power supply:	AC adapter (230 VAC, 50 Hz, 20 VA) Battery pack (4.8 VDC, 6W)
Electric shock protection method:	Class II B type
Dimension:	139x203x131 mm (5.1/2"x8"x5.1/6")
Weight:	approx. 910 g
Complies with:	EN 1060, EN60601-1-1 - 2007

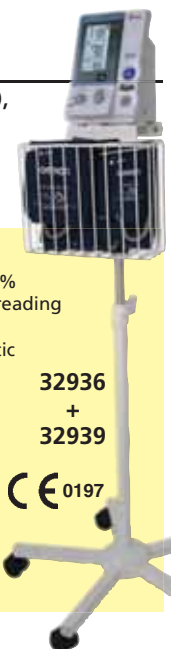

32936

+  
32939

CE 0197

## DALLAS SPHYGMO: WALL AND TROLLEY

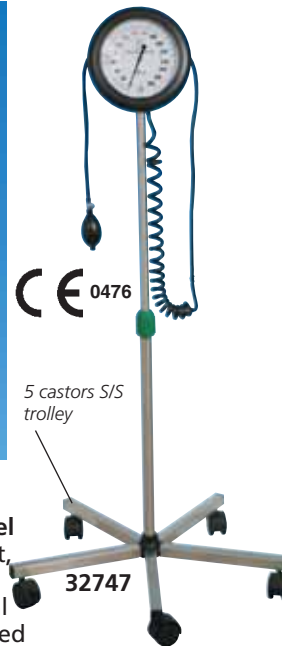

- **32749 DALLAS SPHYGMOMANOMETER - wall model**  
Provided with rear plastic basket for cuff storage.
  - **32747 DALLAS SPHYGMOMANOMETER - trolley model**  
Provided with stainless steel trolley adjustable in height, with 5 castors.
- All DALLAS sphygmometers are provided with extra large dial plate (Ø 150 mm) for easy reading, black nylon calibrated cuff and latex quality inflation system and bladder. Scale 0-300 mmHg.

## DENVER SPHYGMO

- **32744 DENVER SPHYGMOMANOMETER - trolley - adult cuff**  
Trolley sphygmomanometer, light but with high stability and 360° swivelling castors. Adjustable height (90 to 135 cm) with metal basket. Square-shaped-dial 145x145 mm. Nylon cuff, 2-tube adult TPU bladder, PVC bulb, dual use air-release valve with spring, spiral PVC tube (1.8 m).
  - **32839 CHILD CUFF - black**
  - **32850 ADULT CUFF - black - spare**
  - **32841 ADULT LARGE CUFF - black**
- All cuffs with 2 tubes TPU bladder.

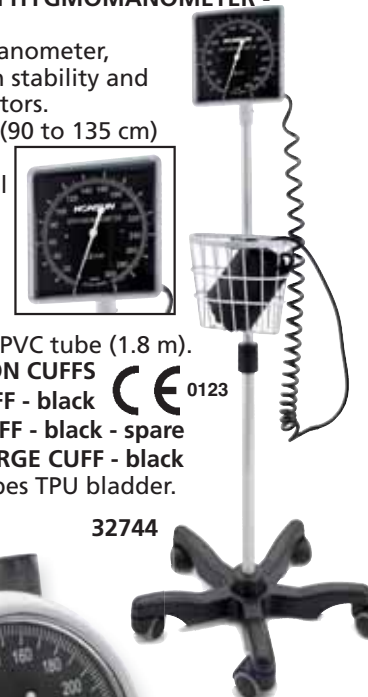

## DAYTON DESK/WALL SPHYGMO

- **32745 DAYTON SPHYGMO - desk/wall model**  
Provided with big dial (Ø 113 mm) for easy reading. Basket with handle easy to move and carry. Nylon cuff with D ring. Wall fixing. Size: 130x130x135 mm - Weight: 180g. Measuring range: 0-300 mmHg ± 3 mmHg.

## JOLLY DIGITAL B.P. MONITOR

## DOMINO DIGITAL B.P. MONITOR



European Society Hypertension



- **32777 JOLLY DIGITAL BLOOD PRESSURE MONITOR**  
Professional Blood Pressure monitor for medical use.
  - large easy-to-read illuminated LCD display 86x74 mm
  - WHO classification
  - arrhythmia detection (IHB)
  - 4-person memory zone - 30 memory space each
  - average of all saved measured values and morning and evening blood pressure of the last 7 days
  - time and date
  - automatic switch-off
- Multilanguage manual and box: GB, FR, IT, ES, PT, DE, PL, GR.
- **32922 CUFF - adult** - 22-30 cm (8-11") - black - spare
  - **32923 CUFF - adult large** - 30-42 cm (11-16") - grey
  - **32920 CUFF - adult extra large** - 42-48 cm (16-18.2") - grey

### TECHNICAL SPECIFICATIONS

Measurement system:	Oscillometric method
Measurement range:	Pressure: 0-300 mmHg ±3 mmHg Pulse: 40-180 pulse/min. ±5%
Power source:	4x1.5 AAA batteries included
Outside dimension:	150x95xh 65 mm
Weight:	approx 235 g (without batteries)

Automatic inflation deflation



- **32803 DOMINO DIGITAL BLOOD PRESSURE MONITOR**
- **32804 DOMINO DIGITAL B.P. MONITOR on trolley with basket**  
Professional Blood Pressure monitor for hospital and medical use.
- extra large LCD display with innovative design
- date/time/ambient temperature (°C/°F) display
- IHB Irregular heartbeat detector
- 120 memories (60 sets for 2 users)
- alarm clock reminding function
- WHO blood pressure classification indicator
- **32802 AC ADAPTOR**
- **32809 ADULT CUFF - spare**
- **32865 COILED TUBING EXTENSION 3 m (42/45 spirals)**

### TECHNICAL SPECIFICATIONS

Measuring range:	Pressure - 40 ~ 260 mmHg	Pulse: 40 ~ 160 beats/min.
Accuracy:	Pressure ± 3 mmHg	Pulse: ± 5%
Power supply:	4x "AA" batteries or AC adaptor (option)	
External dimension:	158(L)x120(W)x127(H) mm	Weight: 490 g

## X-LIFE AUTOMATIC DIGITAL B.P. MONITORS - ESH VALIDATED

Size: 140x104x50 mm  
Weight: 247 g

LCD size 60x51 mm

Cuff size for arm  
circumferences  
23-33 cm



32924

Supplied with  
carrying bag



Size: 74.5x74x30 mm  
Weight: 95 g

LCD size 34.5x42 mm

Cuff size for arm  
circumferences  
13.5-19.5 cm



32926



European Society  
Hypertension



Liquid crystal  
display

- 32924 X-LIFE B.P. MONITOR - arm
- 32926 X-LIFE B.P. MONITOR - wrist

Accurate and precise automatic digital blood pressure meters for smooth and fast measurements with innovative functions:

- IHB: irregular heartbeat detector
- WHO risk category indicator (classifies your measurements in 6 stages of risk, from optimal to severe hypertension)
- proven clinically to meet European Society of Hypertension ESH protocol
- easy to read, wide angle display
- 120 memories for 3 users: 3 zones of 40 memories each
- start/stop unique button, with blue backlight

- multilanguage manual and box: GB, FR, IT, ES
- memory average: automatically average last 3 memories

- 32925 SPARE CUFF for 32924 - adult
- 32927 AC ADAPTOR for 32924

TECHNICAL SPECIFICATIONS	
Measuring method:	oscillometric
Measuring range:	pressure: 0-300 mmHg pulse: 40-199 bpm
Accuracy:	pressure: ±3 mmHg pulse: ±5%
Power supply:	arm type: 4xAAA alkaline batteries wrist type: 2xAAA alkaline batteries
Battery life:	arm type: 300 measures wrist type: 250 measures

## SMART AUTOMATIC DIGITAL B.P. MONITOR - ESH VALIDATION



Display 62x43 mm LCD



European Society  
Hypertension

32921



- 32921 SMART AUTOMATIC B.P. MONITOR with adult cuff

- Compact, fully logic, multiuser, B.P.M. with innovative features:
- smart inflation technology for automatic pumping to proper pressure
  - WHO blood pressure indicator
  - IHB Irregular Heartbeat Detection
  - average value of latest 3 readings
  - 2x60 memories, date and time
  - displays systolic, diastolic and pulse rate separately
  - multilanguage manual and box: GB, FR, IT, DE, ES, PT, PL, GR, Arabic
  - 32922 CUFF - adult - 22-30 cm (8-11") - black - spare
  - 32923 CUFF - adult large - 30-42 cm (11-16") - gray
  - 32920 CUFF - adult extra large - 42-48 cm (16-18.2") - gray

TECHNICAL SPECIFICATIONS	
Measuring method:	oscillometric, automatic inflation and measurement
Measuring range:	cuff pressure: 0-300 mmHg ±3 mmHg pulse rate: 40-180 beats/min ±5% of reading
Power supply:	4x "AA" batteries 1.5 V
Dimensions:	138x98x48 mm
Weight:	211 g (excluding batteries)
Arm cuff:	systolic: 60-260 mmHg diastolic: 40-199 mmHg for arm circumferences 22-30 cm, 30-42 cm or 42-48 cm

## SMART AUTOMATIC DIGITAL WRIST B.P. MONITOR



European Society  
Hypertension

Display 31.9x39.6 mm LCD

32918



- 32918 SMART AUTOMATIC WRIST B.P. MONITOR

- Compact, fully logic, B.P.M. with innovative features:
- smart inflation technology for automatic pumping to proper pressure
  - WHO blood pressure indicator
  - IHB Irregular Heartbeat Detection
  - average value of latest 3 readings
  - 2x60 memories, date and time
  - displays systolic, diastolic and pulse rate separately
  - multilanguage manual and box: GB, FR, IT, DE, ES, PT, PL, GR, Arabic

TECHNICAL SPECIFICATIONS	
Measuring method:	oscillometric, automatic air inflation and measurement
Cuff pressure:	0-295 mmHg ±3 mmHg
Pulse rate range:	40-180 beats/min ±5% of reading
Range of measurement:	30-280 mmHg
Power supply:	2x "AAA" batteries 1.5 V
Dimensions:	84x64x28 mm
Weight:	110 g (excluding batteries)
Wrist cuff:	applicable for wrist circumferences 14-19.5 cm

# GIMA DIGITAL BLOOD PRESSURE MONITORS

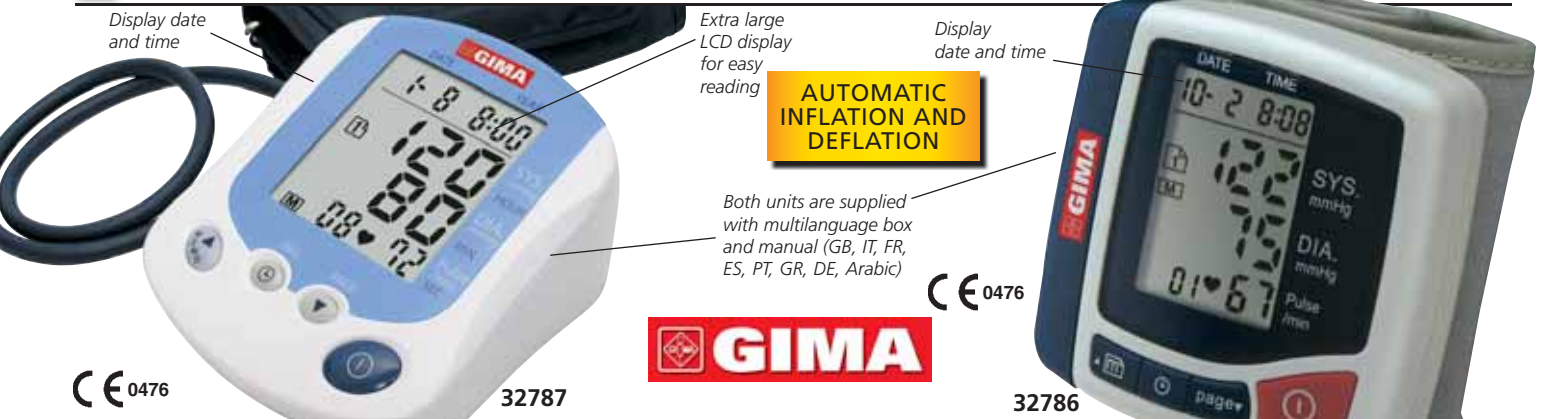

Display date and time

Extra large LCD display for easy reading

Display date and time

**AUTOMATIC INFLATION AND DEFLATION**

Both units are supplied with multilanguage box and manual (GB, IT, FR, ES, PT, GR, DE, Arabic)



CE 0476

32787

CE 0476

32786

- 32787 GIMA AUTOMATIC B.P. MONITOR
- 32788 SPARE CUFF - adult

Innovative design digital fully automatic blood pressure meter:

- one-touch measurement
- 30 sec. measurement time for normal blood pressure
- 4 persons use / 30 memories each - power saving system

- 32786 GIMA AUTOMATIC WRIST B.P. MONITOR
- Reliable digital blood pressure monitor with following features:
- one touch automatic inflation and deflation
  - large LCD display with date and time
  - 2 person use / 60 memories each - power saving system

### TECHNICAL SPECIFICATIONS

Measuring method: oscillometric  
 Display: Systol, Diastol and Pulse  
 Measuring range: 20~280 mmHg (cuff pressure)  
 40~195 beats/min (pulse rate)  
 Accuracy: Pressure:  $\pm 3$  mmHg  
 Pulse:  $\pm 5\%$  of reading  
 Power supply: 4x "AA" batteries  
 Dimensions: 140x120x70 mm  
 Weight: 300 g (ex. batteries) Arm cuff: 22-34 cm



### TECHNICAL SPECIFICATIONS

Measuring method: oscillometric  
 Measuring range: Pressure 20~280 mmHg  
 Pulse 40~195  
 Accuracy: Pressure:  $\pm 3$  mmHg  
 Pulse:  $\pm 5\%$  of reading  
 Power supply: 2x "AAA" batteries  
 Dimensions: 80x60x75 mm  
 Weight: approx 130 g (including cuff, ex batteries)  
 Wrist circumference: 13.5 - 19.5 cm



# ANDON VALUE DIGITAL B.P MONITOR

- 32901 ANDON B.P. MONITOR
- 32922 CUFF - adult - 22-30 cm
- 32923 CUFF - adult large - 30-42 cm
- 32920 CUFF - adult extra large - 42-48 cm



**TECHNICAL SPECIFICATIONS**  
 Measurement system: Oscillometric method  
 Measurement range: Pressure: 0~300 mmHg  $\pm 3$  mmHg  
 Pulse: 40~180 pulse/min  $\pm 5\%$   
 Power Source: 4x1.5 V AAA batteries - not included  
 Dimensions - weight: 107x80xh 52 mm - 170 g (ex. batteries)  
 LCD size: 66x58.5 mm

- large easy to read LCD display, WHO blood pressure indicator
- 4 groups x 30 times with time and date stamp
- average of all saved measured values and morning and evening blood pressure for the last 7 days
- arrhythmia detection (HB)
- automatic switch-off.



Cuff circumference: 22-30 cm



32901

# FULLY AUTOMATIC B.P.M.

Manual in GB, FR, IT, ES, DE, PT, GR, AR

Supplied with light blue cuff in a light blue bag



- 32947 WIDE BLOOD PRESSURE MONITOR
- easy to use and clear LCD display
  - 60 memories
  - automatic switch-off
  - for upper arm circumference 22-30 cm
- 32922 ADULT CUFF 22-30 cm - black - spare
  - 32923 ADULT L CUFF 30-42 cm - grey
  - 32920 ADULT XL CUFF 42-48 cm - grey



**TECHNICAL SPECIFICATIONS**  
 Measurement system: Oscillometric method  
 Measurement range: Pressure: 0~300 mmHg  $\pm 3$  mmHg  
 Pulse: 40~180 pulse/min  $\pm 5\%$   
 Power Source: 4xAAA batteries  
 Dimensions - weight: 220x66xh 43 mm - 230 g (without batteries)  
 LCD size: 102.2x27.3 mm

# TALKING B.P. MONITOR

Voice helps user, explaining how to measure pressure, and telling obtained results.

**B.P. MONITOR WITH VOICE**



- 32940 TALKING BLOOD PRESSURE MONITOR\* - GB, FR, ES, PT, Arabic
  - 32941 TALKING BLOOD PRESSURE MONITOR\*\* - IT, SE, FI, DE, TR
  - 32942 TALKING BLOOD PRESSURE MONITOR\*\* - IT, RO, BG, HU, RU
- \*Manual: GB, FR, ES, PT \*\*Manual: IT, GB
- 32943 AC ADAPTER 230V - 50 Hz
  - 32922 ADULT CUFF 22-30 cm - black - spare
  - 32923 ADULT L CUFF 30-42 cm - grey
  - 32920 ADULT XL CUFF 42-48 cm - grey



Features:

- large easy-to-read LCD display
- arrhythmia detection (IHB)
- time and date
- for arm circumference 22-30 cm
- WHO classification
- 60 memories
- automatic switch-off
- illuminated operation button

**TECHNICAL SPECIFICATIONS**  
 Measurement system: Oscillometric method  
 Measurement range: Pressure: 0~300 mmHg Pulse: 40~180 pulse/min  
 Accuracy: Pressure:  $\pm 3$  mmHg Pulse:  $\pm 5\%$   
 Power Source: 4xAA batteries, optional AC/DC 6V adapter  
 Dimensions - Weight: 153x108xh 60 mm - 290 g (without batteries)  
 LCD size: 60x71 mm

# OMRON DIGITAL BLOOD PRESSURE METERS



The IntelliSense™ technology ensures that the right inflation pressure is automatically detected. It detects irregular pulses and decides fully automatically if the measurement result is usable or the measurement needs to be repeated. Only accurate results are displayed.



OMRON connect mobile application for iPhone/Android

OMRON BLOOD PRESSURE MONITOR USER GUIDE

	M7 INTELLI IT	M6 COMFORT IT	M3	M2	RS3
Clinically validated*	X	X	X	X	X
Intellisense technology	X	X	X	X	X
Irregular heartbeats detector	X	X	X	X	X
Cuff position detector	X	X	X	X	X
Cuff	Moulded comfort cuff 22-42 cm	Moulded comfort cuff 22-42 cm	Long lasting cuff 22-42 cm	Cuff 22-32 cm	Wrist cuff 13,5-21,5 cm
Memory measurements	100 for 2 users	100 for 2 users	60 for 2 users	30	60
Movement detector	X	X	X		
Blood pressure light indicator**	X	X	X		
Average 3 last measurements***	X	X	X		
Morning hypertension	X	X			
Intelli Wrap technology****	X	X			
PC connection	X				

\*To verify validations, please see [www.dablededucational.org](http://www.dablededucational.org)  
 \*\*Signal in case the values exceed the E.H.S. standards for domiciliary auto-measurements (85 systolic pressure and/or 135 diastolic pressure)  
 \*\*\*Average of 3 last measurements made in a 10 min period of time  
 \*\*\*\*360° accuracy: accurate measurements from any position around the upper arm



CE 0197

- 32949 OMRON M7 INTELLI IT - HEM-7322T-E  
With Intelli wrap cuff technology. Cuff 22-42 cm.  
The connect OMRON app for smartphone allows to monitor parameters, create personalized programs, download data on PC and share them with physician. Multilanguage box and manual: GB, FR, IT, ES, DE, NL, RU, TR, Arabic.
- 32929 AC/DC ADAPTOR



Intelli wrap cuff fits normal and large arms and eliminate inaccurated readings associated with incorrect positioning

CE 0197

CE 0197

CE 0197

- 32944 OMRON M2 HEM-7121-E with Easy cuff 22-32 cm. Multilanguage box and manual: GB, FR, IT, ES, DE, NL, RU, TR, Arabic.
- 32933 ADULT EASY CUFF 22-32 cm - HEM-CR24 - spare
- 32929 AC/DC ADAPTOR

- 32928 OMRON M3 HEM-7131-E With Easy cuff 22-42 cm. Multilanguage box and manual: GB, FR, IT, ES, DE, NL, RU, TR, Arabic.
- 32938 ADULT EASY CUFF 22-42 cm - HEM-RML31 - spare
- 32929 AC/DC ADAPTOR

- 32948 OMRON M6 COMFORT - HEM-7321-E With Intelli wrap cuff technology. Cuff 22-42 cm. Multilanguage box and manual: GB, FR, IT, ES, DE, NL, RU, TR, Arabic.
- 32929 AC/DC ADAPTOR



CE 0197

- 32932 OMRON RS3 HEM-6130-E Multilanguage manual and box: FR, IT, NL, DE, Arabic

TECHNICAL SPECIFICATIONS

	32944 M2	32928 M3	32948 M6 32949 M7	32932 RS3
Measuring method:	oscillometric			
Measuring range: Pressure:	0 mmHg to 299 mmHg ± 3 mmHg			
Pulse:	40 to 180 min ± 5% of display reading			
Memory (with date and time):	30	60x2 users	100x2 users	60
Inflation:	fuzzy logic controlled by electric pump			automatic
Deflation:	automatic pressure release valve			automatic
Rating:	6VCC 4W			
Power source:	4 "AA" batteries 1.5 V	4 "AA" batteries 1.5 V		2 "AAA" batteries 1.5 V
Battery life (N° of measurements):	1000	1000	1000	300
Protection against electric shock:	internally powered ME equipment (when using batteries)			
Weight (console+cuff) whitout batteries:	250+130 g	280+170 g	380+163 g	101 g
Size:	103x80 xh 129 mm	107x141xh 79 mm	124x161xh 90 mm	78x60 xh 21 mm
Cuff materials:	nylon and polyester			
Measurable circumference:	22-32 cm	22-42 (arm)	22-42 (arm)	13.5-21.5 (wrist)

# MICROLIFE AFIB BLOOD PRESSURE MONITOR - STROKE PREVENTION



Size: 150x100x50 mm  
Weight: 385 g

CE 0044  
Size: 160x80x32 mm  
Weight: 298 g

5 YEARS WARRANTY



## microlife

### DETECTION OF ATRIAL FIBRILLATION

#### MICROLIFE AFIB technology

An innovative and patented technology for the early detection of Atrial fibrillation (AF) More than 30,000 fatal strokes can be prevented within the European Union by using Microlife AFIB Technology in primary care The new Microlife AFIB technology allows simultaneous blood pressure measurement and AF screening. Microlife AFIB technology detects AF with high sensitivity (97-100%) and specificity (89%) as demonstrated in several clinical studies. Nice guidelines for "Diagnosis and assessment of hypertension" recommended using AFIB screening for routine blood pressure measurement in primary care. AF screening by using a Microlife AFIB device is highly recommended in patients that have to monitor their blood pressure while at home.

- 32868 MICROLIFE WatchBP Home A (Professional use) + SOFTWARE
- detection of atrial fibrillation (specific heart arrhythmia)
- embedded ESH/AHA measurement guidelines lead to accurate home measurement data physician can trust in
- automated data tabulations displays averages for morning, evening and overall measurement
- clinically tested (BHS protocol)
- MAM technology (automatic analysis of 3 consecutive measurements)
- 250 Data memory in «USUAL» mode
- USB port and mains adapter port
- low battery indication
- 4x1.5 V AA batteries
- Supplied with carrying bag, USB cable, soft cuff 22-32 cm software (GB) and manual (GB, IT, FR, ES). Other languages available from web (DE, CZ, DK, GR, FI, HU, NL, NO, PL, RO, RU, SE, SK, SI, YU, UA).
- 32869 ADULT LARGE CUFF 32-42 cm
- 32864 ADAPTER DC 6V, 600 mA

- 32867 MICROLIFE AFIB EASY (Home use)
- detection of atrial fibrillation (specific heart arrhythmia)
- clinically tested (BHS protocol)
- MAM technology (automatic analysis of 3 consecutive measurements)
- 1 Data memory
- traffic light indicator
- low battery indicator
- rechargeable battery-friendly
- mains adapter port
- equipped with world's latest technologies
- Clinically reliable measurements with AFIB & MAM
- 5 years warranty
- Supplied with carrying bag, preformed conical cuff 22-42 cm and manual (GB, FR, IT, DE). Other languages available from web: AR, BG, DK, NL, EE, FI, GR, KZ, LV, LT, NO, PT, RO, RU, ES, SE, UA.
- 32866 ADAPTER DC 6V, 600 mA
- 32884 ADULT CUFF M-L 22-42 cm - spare
- 32885 ADULT CUFF L-XL 32-52 cm

# A&D BLUETOOTH BP MONITOR



ITHB ClinicalBy Validated Bluetooth CE 0366

- 32907 UA-767 BLUETOOTH® BLOOD PRESSURE MONITOR B.P.M. clinically proven in accuracy, with Bluetooth®.
- compatibility with Bluetooth® Android receivers, iOS and Windows
- built-in real time clock
- 200-measurement memory
- irregular Heart Beat Indicator
- extra-large 3-line display for easier reading of results
- one-touch measurement
- comfortable Slim Fit cuff 22-32 cm (8.7"-12.6")
- Supplied with carrying case, batteries and multilanguage manual (GB, FR, ES, IT, DE)

TECHNICAL SPECIFICATIONS	
Method	Oscillometric
Display type	Digital, LCD16 mm /10 mm digit height, pressure and pulse displayed simultaneously
Measurement range	20 - 280 mmHg (pressure)   40 - 200 pulse/minute (pulse)
Accuracy	± 3 mmHg (pressure)   ± 5% (pulse)
Pressurization	Automatic pressurization by micro pump
Depressurization	Constant speed exhaust valve
Deflation	Automatic exhaust by electromagnetic valve
Power supply	4AA alkaline batteries (R6P) for 450 measurements
Dimensions / Weight	64x147x110 mm / Approximately 300 g (0.66 lb)
Wireless communication	Bluetooth 2.1 Class 1 SSP, SPP
Compatible with	2 net QUALCOMM LIFE platform

## GEMINI BLUETOOTH 4.0 SPHYGMOMANOMETER

CE 0123 FDA



32908

• **32908 GEMINI BLUETOOTH SPHYGMOMANOMETER**

- Electronic sphygmomanometer with fully automatic measurement of blood pressure.
- wide blue mode backlight LED display 12.8x5 cm.
  - 60x2 groups memory
  - average function for the last 3 measured values
  - IHB function (irregular beat detection)
  - WHO graduation (B.P. classification indicator)
  - Bluetooth 4.0 connectivity, free APP (iOS and Android) to manage and track BP measurements

• **32909 DC 6V POWER ADAPTER**

**TECHNICAL SPECIFICATIONS**

MWI Technology (Measuring While Inflating)  
 Measuring range: Pressure: 0-300 mmHg ± 3 mmHg  
 Pulse: 40-199 beats/min ± 5% of reading  
 Power supply: 4xAAA batteries (not included)  
 DC 6V power adaptor - optional  
 Size: 182x100x39 mm Arm cuff: 22-32 cm

## ADULT AND PEDIATRIC B.P. MONITOR WITH SpO<sub>2</sub> OPTION

CE 0123 FDA

Supplied with medium cuff (18-26 cm) and multilanguage manual (GB, FR, IT, ES, PT)



32902

PC software for data review, result analysis, trend chart observation and report print

• **32902 LEO ELECTRONIC SPHYGMOMANOMETER - with software**

- Electronic sphygmomanometer with fully automatic measurement of blood pressure and large, high definition colour LCD display. Suitable for adult, pediatric and neonatal use.
- data storage (3 users) for up to 100 groups of data
  - automatic one-touch operation
  - alarm function with possibility to set alarm limits
  - dual scales: kPa and mmHg
  - selection of five cuff sizes
  - automatic power off
  - optional SpO<sub>2</sub>

**TECHNICAL SPECIFICATIONS SPO<sub>2</sub>**

SpO<sub>2</sub> range: 0%-100% (resolution 1%)  
 SpO<sub>2</sub> accuracy: 70%-100%: ± 2%  
 PR range: 30-250 bpm, (resolution 1 bpm)  
 PR accuracy: ± 2 bpm or ± 2% (select larger)

• **80556 POWER ADAPTOR**

GIMA code	SPO <sub>2</sub> PROBES*
32903	SpO <sub>2</sub> reusable adult probe
33755	SpO <sub>2</sub> disposable adult probe
33756	SpO <sub>2</sub> disposable child probe (3-20 kg)
33757	SpO <sub>2</sub> disposable pediatric probe (10-50 kg)
80558	Extension cable for SpO <sub>2</sub> probes

\*All SpO<sub>2</sub> probes need extension cable

GIMA code	CUFFS	Size	Suitable for
80551	Small	6-11 cm	Child small
80552	Small/medium	10-19 cm	Child
80553	Medium	18-26 cm	Adult
80554	Large	22-32 cm	Adult large
80555	X-Large	33-47 cm	Adult extra large

**TECHNICAL SPECIFICATIONS SPHYGMO**

Measurement method: oscillometric  
 Measurement range: 0-38.67 kPa (0-290 mmHg)  
 Resolution: 1 mmHg  
 Accuracy: static pressure: ±0.4 kPa (±3 mmHg)  
 Inflation - Deflation: automatic inflation - automatic multistep deflation  
 Display: 2.8" colour LCD screen, USB interface  
 Power: four "AA" batteries or optional power adapter  
 Safety: class II device type BF applied part  
 Dimension - Weight: 130x110x80 mm - 300 g

## 24 HOURS BLOOD PRESSURE MONITOR SYSTEM

CE 0476



32780

• **32780 DAILY ABPM + software**

- A simple, economic and small size unit for 24 hours ambulatory blood pressure monitoring. Main features:
- 4 - memory zones, 99 - readings each (total 396 measurements)
  - patient-friendly performance at affordable price
  - automatic measurement by two predetermined intervals
  - irregular Heartbeat detector, detect a disturbance in the regular rhythm of the heartbeat
  - big LCD display showing measuring date and time
  - 5 - mode average function, by hour, day, week, month and overall
  - transfer to PC via software and USB plug of measured values
  - lithium battery, long - time measurement
- Supplied with arm cuff (22-34 cm) carrying bag and software.

• **32783 ADULT CUFF - spare**

• **32784 LITHIUM BATTERY - spare**

**TECHNICAL SPECIFICATIONS**

Measuring type: Oscillometric system  
 Measuring range: Pressure: 20-80 mmHg ± 3 mmHg  
 Pulse: 40-195 beats/min ± 5%  
 Power supply: Lithium Battery, 3.7 V 1050mA  
 Weight: Approx. 260g (including cuff, ex. batteries)  
 External dimension: 184x84x33 mm Arm cuff: 22-34 cm

## 24 HOURS ABPM, SpO<sub>2</sub> AND PULSE RATE AMBULATORY MONITOR

- 35110 GIMA ABPM + Pulse rate with software
  - 35112 GIMA ABPM + Pulse rate with software and Bluetooth
  - 35111 GIMA ABPM + Pulse rate + SpO<sub>2</sub> with software
- GIMA ABPM module measures the blood pressure using the oscillometric method with step deflation. Two modes of measurement: manual and automatic. Each mode displays the diastolic, systolic and mean blood pressure. In the MANUAL mode, only one measurement is conducted for each time. In the AUTO mode, the measurement is cycled; you can set the interval time to 5/10/15/20/30/45/60/90 min. (35111) or 15/30/60/120/240 min. (35110, 35112)
- compact and portable, easy to use
  - suitable for adult, pediatric and neonatal patient
  - large colour LCD display of ABPM, SpO<sub>2</sub> and pulse rate
  - adjustable audible and visual alarms
  - real-time ambulatory monitoring 24 hours storage and review of date
  - clinically proven accuracy
  - all data can be transferred to a PC through Windows-based software or to a smartphone through Bluetooth (35112 only).
  - 35113 CHILDREN CUFF - arm circumference 18-26 cm
  - 35114 ADULT CUFF - arm circumference 25-35 cm
  - 35115 ADULT LARGE CUFF - arm circumference 33-47 cm
  - 35116 THIGH CUFF - thigh circumference 46-66 cm
  - 35117 EXTENSION TUBE FOR CUFFS (35113/4/5/6) - 1.5 m - spare
  - 35118 ADULT SpO<sub>2</sub> PROBE - reusable - spare

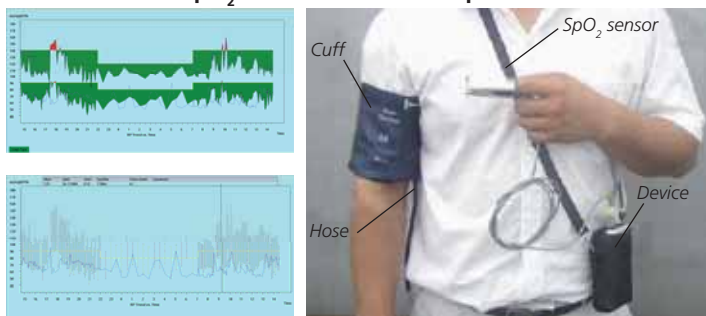

- STANDARD ACCESSORIES**
- Carrying bag
  - 3 nylon cuffs (pediatric, adult, adult large) - latex free
  - SpO<sub>2</sub> probe (only code 35111)
  - User manual: GB, IT
  - Software (GB - IT)
  - latex free
  - Cuff connection tube 1.5 m
  - Batteries

**TECHNICAL SPECIFICATIONS**

Display: colour LCD  
 Power: two "AA", 1.5V alkaline batteries  
 Dimension: 120x80x32 mm  
 Weight: <350 g (including batteries)

**SpO<sub>2</sub> (35111 only)**  
 Measurement range: 0-100%  
 Resolution: 1%  
 Accuracy: 70-100% ±2%  
 Alarm range: 0-100%

**NIBP**  
 Method: oscillometry  
 Mode: manual/automatic/continuous  
 Measurement range: 0-290 mmHg (0 KPa - 38.67 KPa)  
 Automatic measurement interval: 5, 10, 15, 30, 45, 60, 90, 120 min. (35111) 15, 30, 60, 120, 240 min. (35110, 35112)

Resolution: 1 mmHg  
 Overpressure protection: 290 mmHg  
 Alarm: systolic 40-270 mmHg  
 diastolic 20-235 mmHg  
 Map 10-270 mmHg (35111 only)

**Pulse rate**  
 Range: 0-250 bpm (35111) 40-240 bpm (35110, 35112)  
 Resolution: 1 bpm  
 Accuracy: ±1 bpm  
 Alarm range: 30-250 bpm

**Operating system**  
 Windows XP/Seven, 8, 8.1 (at 32 & 64 bit)

## UP TO 52 HOURS AMBULATORY BLOOD PRESSURE MONITOR

- 33351 AM100 GIMA ABPM with adult cuff
- The AM100 is a compact, lightweight instrument that provides a cost-effective solution for monitoring patient's blood pressure outside the clinical environment. AM100 employs the popular oscillometric technique of blood pressure measurement. The simplicity of this technique provides for the quickest patient hook-up. AM100 interfaces with Win Pro PC Software for monitor programming as well as report editing and generation.
- Oscillometric technology:** quick hook-up, making it easy to use, saving your staff time
- Compact and quiet:** silent operation and compact size aid patient compliance.
- Low power consumption:** requires only two "AA" batteries, making this unit much less expensive than others.
- AM100 is supplied complete with software, adult cuff, carrying-bag, English manual and PC connection cable.
- 33348 PEDIATRIC CUFF - arm circumference 18-27 cm
  - 33349 ADULT CUFF - arm circumference 25-35 cm - spare
  - 33353 ADULT LARGE CUFF - arm circumference 33-40 cm



Compact size: 12x7x3 cm, and light, 350 g only, including batteries

**PG WIN PRO PC INTERFACE**

- creates a monitoring plan tailored to an individual patient with up to 3 specific time periods
- generates concise clinical reports.

PG Win reports include full disclosure of blood pressure readings, heart rate, mean arterial pressure, blood pressure load and trend of BP values vs. time. Compatible with Windows 95, XP and Windows 7.

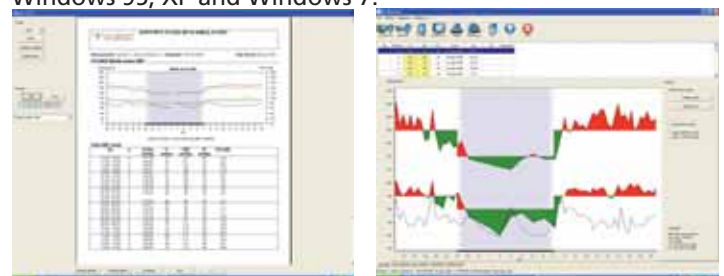

**TECHNICAL SPECIFICATIONS**

Technique: Oscillometry with step deflation  
 Blood pressure range: 25-260 mmHg ±3 mmHg  
 Heart rate range: 40-200 bpm  
 Display: Liquid crystal  
 Recording duration: Up to 52 hours  
 Sample quantity: Over 250 sample of systolic, diastolic, MAP and heart rate  
 Sampling periods: 3 time periods  
 Power source: 3 VDC/Two 1.5 V "AA" Alkaline

## MT 10 - HANDHELD IMPEDANCE TYMPANOMETER

- 33665 MT10 - HANDHELD TYMPANOMETER
  - 33666 MT10 - HANDHELD TYMPANOMETER WITH IPSI-REFLEX
- Professional handheld tympanometer for setting fast and reliable testing in an easy and cost effective way.

### Objective analysis

Fast and easy to operate and provides objective measures that cannot be obtained by otoscopy alone.

### Easy and fast tympanograms

Results can be obtained with little efforts and with no response required from the patient. This is especially beneficial when dealing with difficult-to-test patients or small children.

### Clinical application

Suitable for diagnostic use as tympanometer and (33666 only) reflex responses are all recorded with great detail. You can detect otitis media (a major cause of temporary or permanent hearing impairment in children), a perforated eardrum, cholesteatomas and certain neurological disorders. You can also check tympanostomy tubes and follow up on post medical treatments.

### Ipsilateral Acoustic Reflex (33666 only)

Four different reflex tests at 500, 1,000, 2,000, 4,000 Hz may be performed per ear using either fixed or automatic intensity selection. Actual reflex characteristics are displayed on the screen.

### 30 patients in memory

Can hold test results of up to 30 patients, allowing to screen a large group of patients and print out the data at a later time.

**PC-integration** with optional infrared USB interface and software. Full data-transfer to PC

- 33667 INTERFACE USB ADAPTER AND SOFTWARE BY IRDA PORT



33669



### Interacoustics

Supplied with handle, set of 139 disposable ear-tips (mixed sizes) 4x1.5 V battery and manual in GB, DE, FR, IT, ES, SE, GR, PT, DK, FI, CZ, PL, LT, EE, HU, NL, NO, IS, RO, MK.

- -400 to +200 daPa
- ipsi-reflex (33666 only)
- 30 patient memory
- PC integration



The MT10 is ergonomic to hold but also offers the possibility of using the included handle to make it even more stable and lightweight as it can rest on your arm during the measurement.

Size: 19x8x4 cm excluding probe (length with probe 22.5 cm)  
Weight 285 g without battery

- 33668 BET55 SET OF DISPOSABLE EAR-TIPS - box of 139 mixed sizes
- 33669 SANIBEL MPTII PORTABLE THERMAL PRINTER
- 33670 THERMAL PAPER ROLLS - box of 3

### TECHNICAL SPECIFICATIONS

#### Tympanometry

Analysis performed: Peak compliance; peak pressure, gradient; equivalent ear canal volume  
Probe tone: 226 Hz  
Pressure levels: +200 daPa to -400 daPa  
Ear volume measurement range: 0.2 ml to 5 ml  
Sweep speed: Typically 200-300 daPa/sec; depending on ear & cavity volume  
Pressure limits (safety shut off): +600 to -800 daPa

#### Reflex measurements (33666 only)

Measurement mode: ipsilateral  
Reflex tone levels: 500 Hz, 1 kHz, 2 kHz, 4 kHz  
Four reflex levels: 100 dB with 5 dB or 10 dB steps; 95 dB, 90 dB or 85 dB with 5 dB steps  
Reflex analysis: Reflex pass/refer at each level tested; Maximum amplitude of each reflex (seen on printed report and PC report); Pressure at which reflex was performed

#### Data management

Data storage: 30 records. Any recording can be stored once the tympanogram is viewed  
Data held: Patient Initials, Tympanogram and Reflex graphs and analysis for Left and/or Right Ear, Time and Date of recording, which ears were tested, whether or not the record has been printed and sent to a PC, parameters printed and/or sent to a PC, parameters used for analysis

#### Other data

Internal backup: >30 days without main batteries fitted  
Battery Lifetime: Approx. 400 tests (Alkaline AA batteries)  
Supported printer: Martel MCP8830 or Sanibel MPTII  
Interface: Infra-red, IrDA hardware, 9600 baud  
Information printed: Space for patient and clinician's details, Tympanogram analysis parameters, Tympanogram, Reflex analysis parameters, Reflex graph, S. N. of device, Last and Next Due Calibration dates  
Safety standards: IEC 60601-1, EMC: IEC 60601-1-2  
Impedance standard: IEC 60645-5, Type 2 Tympanometer

## PA5 PEDIATRIC PORTABLE AUDIOMETER



- 33601 PA5 AUDIOMETER
- 33602 TDH39 AUDIOMETRIC HEAD PHONE

Paediatric portable audiometer with air conduction, free-field and visual stimulation capabilities. By means of a headphone it can be also used as a regular screening audiometer for adults. PA5 helps doctors in evaluating the auditory behaviour in neonates and infants till 24 months by means of specific tests:

### Auropalpebral Reflex (APR) test

APR test is a startle reflex of the eyelid elicited by relatively strong sounds that can be performed on neonates from the day of birth. It is not based on co-operation with the newborn child.

### Conditioned Orientation Response (COR) test

Based on the "Orientation Reflex", a natural reflex movement elicited by sound or visual stimulation. If the visual stimulation elicits a reflex which is conditioned by a tone, the child will look towards the visual stimulation as soon as the tone is heard. If the conditioning is effective the child will look in the direction of the sound source even before the visual stimulation is presented.

### Visual Reinforcement Audiometry (VRA) test

VRA test is an extension and modification of COR, where the cooperation with the child is less important. Not only the sound

localisation orientation reflex are accepted but also four other reactions: reflex reactions (body and face), search reactions, orientation reactions and spontaneous reactions.

### Reflex audiometry and maturation of auditory response tests

Different stimuli are presented in terms of intensity, frequency, duration, direction of sound in order to elicit proper reactions like waking-up, crying, astonishment, direct sound localization.



Supplied with GB manual and quick guide (GB, US, DE, FR, SE, IT, PT, DK, FI, ES, GR, CZ, PL, NL, NO, EE, HU, SL).

33601

### TECHNICAL SPECIFICATIONS

Frequencies: 500, 1,000, 2,000, 3,000, 4,000 Hz  
Stimuli: Warble tone, NB and WN  
Intensities: Distance 50 cm: 20/30-80dB HL in 10dB steps, for Warble Tone and WN 10/20-70dB for NB and WN 10/20-70dB for NB  
Distance 16 cm: increases intensity by 10 dB  
Dimensions - weight: LxWxH: 25x7x5 cm - 360 g  
Power supply: 3AA batteries (included)

## BOEL STYLE PEDIATRIC AUDIOLOGY TEST



- 33599 GIMA AUDIOTEST - pediatric audiology test for early detection of childhood deafness

The Boel test is a unique screening tool that tests the hearing abilities and child's response to a sound stimulus, even at an early age (between 6 to 10 months). GIMA audiotest is based on the BOEL test both for the ergonomics (designed to be held in the palm of the hand not visible to the child) and the standard sound of the bells. The two sound stimuli emitted by the audiometer reproduce a dull

low-frequency tone located at about 125-150 Hz and an acute high-frequency tone located at about 5.0-5.1 kHz in exactly the same way as the bells of the Boel test (amplitude 86dBA; 96dBA). Testing the child's response to these highly significant thresholds. Easy to use, with only two buttons for the selection of two frequencies, lightweight and battery-powered.



33599

Class I medical device according to 93/42/EEC. Made in Italy.

# AUDIOMETRIC BOOTHS - CONFORM TO 93/42/CEE - 2007/47/CE - Class I

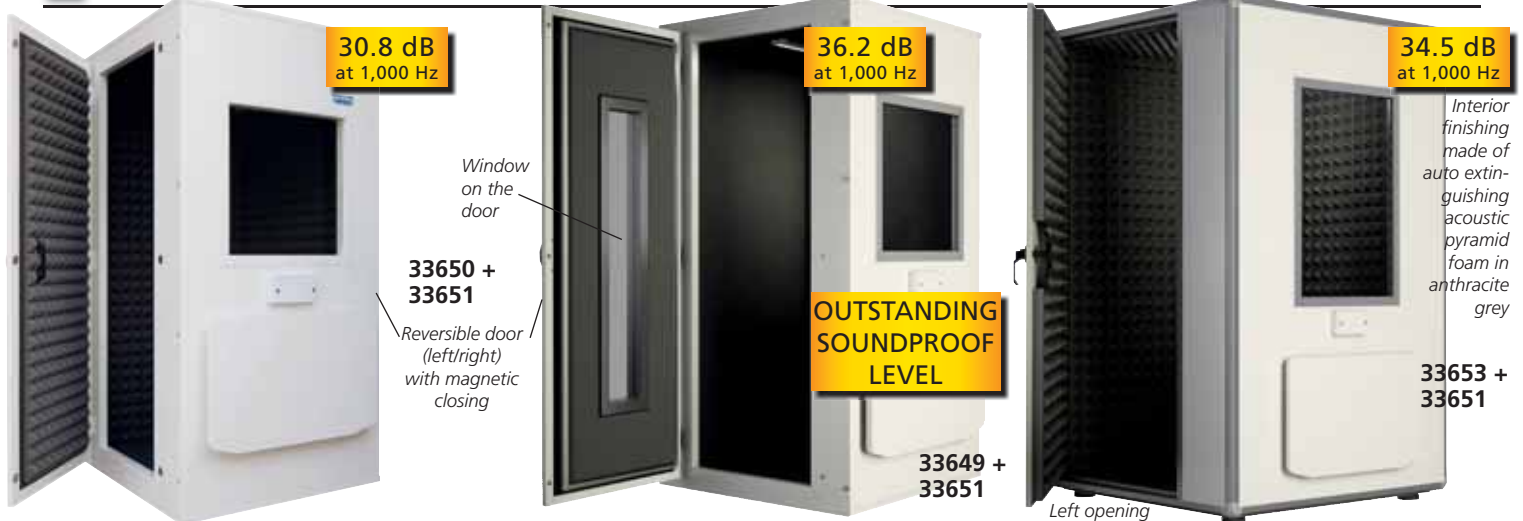

- **33650 PRO 25 - 96x96x197 cm**  
Portable, lightweight, sound proof booth, easy to install in few minutes. Interior finishing made of acoustic pyramid foam in anthracite grey. External finishing made of highly resistant, fire proof washable panel. Module for cable connection included. Made in Italy.
- **33651 TABLE - 79x50 cm**

ACOUSTIC INSULATION						
Hertz	125	250	500	1000	2000	4000
PRO 25 dB	18.0	16.0	26.7	30.8	28.8	30.9
PRO 28 dB	21.7	25.6	32.6	36.2	34.0	41.1
PRO 30 dB	23.4	24.1	27.8	34.5	31.3	36.4

- **33649 PRO 28F - 96x96x197 cm**  
New compact booth with an outstanding level of sound proofing and excellent acoustic thanks to innovative materials. Internal finishing made of fire proof, washable and very resistant fabric. Internal ventilation system. External finishing made of highly resistant, fireproof, washable panel. Module for cable connection included. Made in Italy.
- **33651 TABLE 79x50 cm**

- **33654 PRO 30 - 107x107x242\*\* cm**
- **33653 PRO 30 - 132x132x242\*\* cm**
- **33655 PRO 30 - 211x107x242\*\* cm**
- **33656 PRO 30 - 211x211x242\*\* cm**
- **33657 PRO 30 - size on request**  
available any size from 1x1 to 3x3  
Range with different sizes, with high noise reduction and ventilation system. External finishing made of highly resistant, fireproof, washable panel and aluminium frame. Module for cable connection included. Made in Italy.
- **33651 TABLE 79x50 cm**
- **33652 RAMPS for wheelchair access**

	33650	33649	33654	33653	33655	33656
External size (cm):	96x96xh 197	96x96xh 197	107x107xh 242**	132x132xh 242**	211x107xh 242**	211x211xh 242**
Internal size (cm):	81x81xh 180	81x81xh 173.5	92x92xh 201	117x117xh 201	196x92xh 201	196x196xh 201
Door size cm:	55xh 168	55xh 168	75xh 200	75xh 200	75xh 200	75xh 200
opening:	Left/Right	Left/Right	Right*			
Windows size cm:	56xh 56	56xh 56	56xh 88			
material:	2 - crystal insulating safety glass					
Wall thickness cm:	7.5	7.5	7.5	7.5	7.5	7.5
Weight (kg):	198	233	255	317	356	552
Ventilation:	no	yes	yes	yes	yes	yes
Tested noise reduction dB at 1,000 Hz:	30.8	36.2	34.5			
Internal illumination power V-Hz:	230 - 50/60		86-265 - 50/60			
Norms:	Class I Medical Devices European Directive 93/42 CEE					



- STANDARD ACCESSORIES**
- module for silent audiometer cable connection
  - internal illumination
  - ventilation system (PRO 28, PRO 30 only)
  - ISPM-15 wooden box for transport
  - manual: GB, IT

# SINGLE USE TYMPANOMETER EARTIPS - FOR MOST BRANDS



SANIBEL™ ear tips were designed for use with acoustic immittance instruments and otoacoustic emission system. Made of a soft and sticky biocompatible material, these ear tips greatly improve the ease of obtaining and keeping a good seal, allowing the tester to quickly move on to other tasks. Available in different sizes, with different shapes (mushroom and flanged ear tips for infants). The complete range makes it possible to accommodate all ear canal shapes and sizes. All Sanibel™ ear tips are latex free.

GIMA code	SANIBEL™ AZE MUSHROOM EAR TIPS	Minimum order
53500	Ear tip 6 mm - violet	bag of 100 pcs
53501	Ear tip 7 mm - yellow	bag of 100 pcs
53502	Ear tip 9 mm - green	bag of 100 pcs
53503	Ear tip 10 mm - light blue	bag of 100 pcs
53504	Ear tip 11 mm - white	bag of 100 pcs
53505	Ear tip 13 mm - yellow	bag of 100 pcs

GIMA code	SANIBEL™ ADI FLANGED INFANT EAR TIPS	Minimum order
53515	Ear tip 3-5 mm - red	bag of 100 pcs
53516	Ear tip 4-7 mm - blue	bag of 100 pcs
53517	Ear tip 5-8 mm - yellow	bag of 100 pcs
GIMA code	SANIBEL™ ADI MUSHROOM EAR TIPS	Minimum order
53520	Ear tip 7 mm - blue	bag of 100 pcs
53521	Ear tip 8 mm - yellow	bag of 100 pcs
53522	Ear tip 9 mm - green	bag of 100 pcs
53523	Ear tip 10 mm - red	bag of 100 pcs
53524	Ear tip 11 mm - blue	bag of 100 pcs
53525	Ear tip 12 mm - yellow	bag of 100 pcs
53526	Ear tip 13 mm - green	bag of 100 pcs
53527	Ear tip 14 mm - red	bag of 100 pcs

**VERIFIED COMPATIBILITY FOR SANIBEL™ AZE**

Grason-Stadler® Tymptar™  
Interacoustics® AT235™ & AT235h™ with black probe tip  
AA222™ & AA220™ with black probe tip old MT10™

Maico® MI24™, MI26™, MI34™, MI44™ with black probe tip  
Kamplex® All tympanometers

**VERIFIED COMPATIBILITY FOR SANIBEL™ ADI**

Amplivox® Otowave™ with clear (Type 1) probe  
Interacoustics® AT235™ & AT235h™ with clear probe tip adapter  
AA222™ & AA220™ with clear probe tip adapter  
Eclipse™ and MT10™ with clear probe tip, Titan™

Maico® MI24™, MI26™, MI34™, MI44™ with clear probe tip adapter  
easyTimp™ - Otowave™ - Ero-scan plus™ - easyScreen™

MEDRx® Otowave™  
Grason-Stadler® Corti™

## SCREENING AUDIOMETER

2 lines of 24 characters backlit display

53550

Weight: 720 g  
Dimension: 252x170x65 mm  
Operating power: 100-240 V, 50-60 Hz

**53550 AMPLIVOX 116 SCREENING AUDIOMETER - air conduction**  
Combines style and functionality, the ideal manual screening audiometer for primary care, school and workplace. It offers a comprehensive air conduction threshold facility at very affordable price.

- pure tone, continuous, pulsed and warble tones
- threshold retention function
- talk forward function
- 125 to 8,000 Hz test frequency
- -10 to 100 dBHL

Supplied with audiometric headset, patient response switch, audiogram cards (box of 50) main power adaptor, carrying case and manual (GB, IT, ES, on request FR, SE, PT).

- 53555 PELTOL INSULATION HEADBAND
- 53556 AUDIOGRAM CARDS - box of 50



53555

## DIAGNOSTIC AUDIOMETER

2 lines of 24 characters backlit display

53551

Weight: 735 g  
Dimension: 270x175x68 mm  
Operating power: 100-240 V, 50-60 Hz

**53551 AMPLIVOX 240 DIAGNOSTIC AUDIOMETER - air, bone, masking**  
Cost-effective diagnostic audiometer, ideal for desktop and mobile use.

- USB connectivity
- threshold retention function
- single, pulsed or warble tone preset
- 11 test frequencies: 125 to 8,000 Hz (AC), 250 to 8,000 Hz (BC)
- -10 to 120 dBHL range (AC), -10 to 70 dBHL (BC), 90 dBHL max (250 to 4,000 Hz) insert masking output
- automatic AC test functionality

Supplied with audiometric headset, bone conductor headset, patient response switch, audiogram cards (box of 50), main power adaptor, carrying case and manual (GB, IT, ES, on request FR, SE, RU, PT).

- 53555 PELTOL INSULATION HEADBAND
- 53556 AUDIOGRAM CARDS - box of 50
- 53557 INSERT FOR MASKING



53557

## SCREENING DIAGNOSTIC AND CLINICAL 2 CHANNEL AUDIOMETERS

Dimension: 390x260x105 mm  
Weight: 2.4 kg without accessories  
Power: 100-240 V, 50/60 Hz

LCD alphanumeric backlight  
2 lines of 16 characters



Programme to personalize the audiometer according to the needs of the user

- 33623 SIBELSOUND 400-A SCREENING AUDIOMETER - air conduction
- 33624 SIBELSOUND 400-AOM DIAGNOSTIC AUDIOMETER - air + bone + masking
- 33626 SIBELSOUND 400-SUPRA CLINICAL AUDIOMETER - air + bone + mask + supraliminal tests + W50 software

The SIBELSOUND 400 is a two-channel digital audiometer based on DSP processing. This audiometer is designed for quick and easy audiometric exploration of hearing thresholds and screening tests, such as suprathreshold pure tone tests (FOWLER-ABLB, TONE DECAY, WEBER, LUSCHER, ...).

- Air conduction (TDH 39): 125 - 8,000 Hz or HF: 8,000 - 20,000 Hz with optional HDA 200
- Levels: AC (-10 to 120 dB HL) / BC (-10 to 70 dB HL) / speech (-10 to 100 dB HL) free field (-10 to 80 dB HL)
- Masking levels (manual or synchronized): NBN AC (-10 to 100 dB HL) NBN BC (-10 to 70 dB HL) white & speech (-10 to 100 dB SPL)
- Tone: continuous, pulse, antenate, amplitude modulation.
- Level increases: 5 (A-AOM), 1 or 5 (SUPRA)
- Frequency precision: ±1% / level precision ±2% db SPL
- Automatic calculation of hearing loss and diagnosis (COUNCIL, IMSS MEXICO, ELI, SAL, KLOCKHOFF, MOH, OTHERS ...)
- Direct USB connection to PC to W50 audiometry software for viewing, storage, transmission, analysis and introduction of audiometric tests (Windows® environment).

- 33628 INTERCOM KIT (headphone + microphone)
- 33621 INSULATION DEVICE for air conduction phone
- 33629 AUDIOMETRY SOFTWARE W50

FREQUENCIES AND LEVELS												
STANDARD FREQUENCY	125	250	500	750	1,000	1,500	2,000	3,000	4,000	6,000	8,000	Hz
MUSICAL FREQUENCY	131	262	523	-	1,047	-	2,093	-	4,186	-	8,372	HZ
Air conduction (THD 39)	80	100	120	120	120	120	120	120	120	110	110	dB HL
Bone conduction (B 71)	-	50	60	60	70	70	70	70	70	55	-	dB HL
Free field	-	70	80	80	80	80	80	80	80	80	-	dB HL
<b>MASKING NOISE</b>												
Narrow bandwidth AC	60	80	100	100	100	100	100	100	100	100	90	dB HL
Narrow bandwidth BC	-	50	60	60	70	70	70	70	70	-	-	dB HL
White AC	-	-	-	-	100	100	100	100	100	-	-	dB SPL
Speech	-	-	-	-	100	100	100	100	100	-	-	dB SPL
<b>LOGO-AUDIOMETRY</b>												
Air conduction	100										dB SPL	
Free field	80 dB at 1m from the patient										dB SPL	
<b>Minimum levels</b>												
All options	-10	-10	-10	-10	-10	-10	-10	-10	-10	-10	-10	dB HL

	SIBELSOUND 400 FEATURES		
	A	AOM	SUPRA
Audiometry type	4 screening	3diagnostic	2 clinical
Air conduction TDH 39	•	•	•
Bone conduction B71		•	•
Masking by white narrow band & speech noise		•	•
Sisi test			•
Supraliminal tests			•
Speechaudiometry + Intercom kit	optional	optional	•
Musical frequencies			•
Intercom data base	150 tests	1,000 tests	1,000 tests
USB connectivity	•	•	•
W50 audiometry software	optional	optional	•
User manual English, Italian (available on request French or Spanish)	•	•	•

**Communication system:**  
- Print directly to a USB printer or connect to W50 Microsoft Windows Audiometry Software.  
**Audiometry software:**  
It allows to manage patient database, display graphically results, compare tests, ... It also allows to input data performed by other audiometers, show automatic diagnosis (council IMSS,...). Compatible Windows 10

## PC OR PC-iPAD CONTROLLED PORTABLE AUDIOMETERS

### PICCOLO PORTABLE AUDIOMETERS

Piccolo is a basic diagnostic audiometer offering air, bone and speech audiometry functions. Piccolo can be controlled either from a computer running Windows or, for the first time ever, from an iPad®. Lightweight, compact design, powerful, user-friendly software and Noah connectivity combine to make Piccolo the ideal choice for professionals on the move.

- three different models available:

**Basic** (AC only) for Pc use

**Plus** (AC/BC) for Pc or Pc-iPad® use (Aero version)

**Speech** (AC/BC/Live Speech) for Pc-iPad® use

- iPad® control (includes Aero option, 33616, 33618 only) through the Maestro App. Wireless Bluetooth connectivity

- computer control through the dedicated Noah or Daisy module. USB connection port

- small and light weight  
- power supply through the USB connection, when controlled by computer.

Made in Italy.

Software language:  
GB, FR, IT, ES, DE, PL, PT, RU.  
CD manual and quick guide  
GB, FR, IT, ES, DE, PL, PT, NL.



#### TECHNICAL SPECIFICATIONS

	Piccolo Basic	Piccolo Plus	Piccolo Speech
Type of device	Pc control	PC (33615) or Pc and iPad® control (33616)	Pc and iPad® control
Class EN 60645-1, ANSI S3.6	4-screening	3-diagnostic	3-diagnostic
Output	AC	AC, BC	AC, BC, Live Speech
Masking	NBN	NBN	NBN, WN, SN
Warble tone	Yes	Yes	Yes
Pulsed tone	0.5 Hz, 1 Hz, 2 Hz	0.5 Hz, 1 Hz, 2 Hz	0.5 Hz, 1 Hz, 2 Hz
Frequency range	125 - 8,000 Hz	125 - 8,000 Hz	125 - 8,000 Hz
Maximum output intensities	AC: -10 to 120 dB HL	AC: -10 to 120 dB HL BC: -10 to 80 dB HL	AC: -10 to 120 dB HL BC: -10 to 80 dB HL
Attenuator step	5 dB	5 dB	5 dB
Automatic audiometry	HW auto threshold	HW auto threshold	HW auto threshold
Speech audiometry	No	No	Yes
Speech inputs	-	-	EXT1, EXT2, Mic
Talk over	External microphone	External microphone	External microphone
Connection to PC	USB [driverless]	USB [driverless]	USB [driverless]
Controlling software	-	Daisy or Noah with Maestro module	-
Connection to iPad	-	Bluetooth 4 (only 33616)	Bluetooth 4
Controlling app	-	Maestro (App Store)	Maestro (App Store)
Dimensions	-	16x16x3cm (16.3x6.3x1.2 in)	-
Weight	300 g (10.6 oz)	300 g (10.6 oz)	300 g (10.6 oz)
Operating voltage	100-240 V, 50/60 Hz	100-240 V, 50/60 Hz	100-240 V, 50/60 Hz

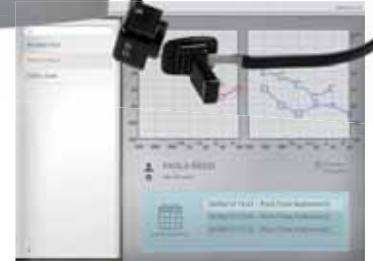

GIMA code	SCREENING AND DIAGNOSTIC AUDIOMETERS	Management
<b>33613</b>	Piccolo Basic screening audiometer - air + mask	PC
<b>33615</b>	Piccolo Plus diagnostic audiometer - air + bone + mask	PC
<b>33616</b>	Piccolo Plus Aero diagnostic audiometer - air + bone + mask	PC + iPad
<b>33618</b>	Piccolo Speech Aero diagnostic audiometer - air + bone + live speech* + mask	PC + iPad

STANDARD ACCESSORIES	
- TDH-39 supra-aural headphones	- Jack/jack cable (Ø 3.5 mm) - 33618 only
- B71 bone vibrator (33615/6/8 only)	- Inventis Daisy Patient Record Manager, with Daisy Maestro module
- Patient response switch	- Noah Maestro module
- Clip-on microphone for operator	- USB connection cable
- to-patient communication	- Medical grande power supply
	- User Manual

\*Speech material IT standard, available on request FR.

## BELL PLUS DIAGNOSTIC AUDIOMETER

• **33635 BELL PLUS DIAGNOSTIC AUDIOMETER - air + bone + mask + software DAISY - MAESTRO**

Bell is a basic diagnostic audiometer performing fast and accurate air and bone conduction threshold examinations. Simple operation, fast and reliable automatic examination mode, user-friendly interface and easy portability make Bell the ideal instrument for private clinics, multi-specialist clinics and occupational medicine application.

- pure tone audiometry in AC and BC
- Hughson-Westlake auto threshold test
- colour graphic display
- internal memory for 100 patients
- cost effective solution

- supplied with air conduction phone and vibrator for bone conduction.

Made in Italy.

### Maestro Software interface

The Maestro module is the software interface of Bell Plus audiometer. When it is connected to PC via USB you can see real time progress of the exam on the display and then download the data. It also allows full control of the audiometer from computer.

#### STANDARD ACCESSORIES

- TDH-39 supra-aural headphones
- B71 bone vibrator
- Patient response switch
- Plastic cover sheet
- Medical grade power supply
- User Manual

#### TECHNICAL SPECIFICATIONS

Type of device	Hybrid audiometer
Class (EN 60645-1, ANSI S3.6)	3 diagnostic
Output	AC, BC
Masking	NBN, WN
Insert masking earphone	Yes
Warble tone	Yes
Pulsed tone	0.5 Hz, 1 Hz, 2 Hz
Frequency range	125 - 8,000 Hz
Maximum output intensities	AC: -10 to 120 dB HL BC: -10 to 80 dB HL
Attenuator step	5 dB
Automatic audiometry	HW auto threshold
Talk over	Internal or external microphone
Display type	Colour graphic
Display size resolution	4.3", 480x272
Internal memory	100 patients
Operating voltage	100-240 V, 50/60 Hz
Dimensions - weight	32x32x9 cm (12.6x12.6x3.5 in) - 1.8 kg (4.0 lbs)



Manual:  
GB, FR, IT, ES, DE, PT.

**33635**

## SPIROTEL SPIROMETERS - BLUETOOTH OPTION

- 33471 SPIROTEL with WINSPIROPRO software
- 33472 SPIROTEL with Bluetooth and WINSPIROPRO software
- 33473 SpO<sub>2</sub> PROBE - adult - optional
- 33410 MOUTHPIECES int Ø 2,8 x ext Ø 3, h 6.5 cm



A pocket laboratory which integrates 4 devices in one:

- spirometer with touch screen display
- triaxial accelerometer with motion analysis for therapy monitoring
- intelligent 3D oximeter with on screen results (with 33473)
- e-diary for home care symptom control.

Compatible with Qualcomm Life 2 net Hub

### TECHNICAL SPECIFICATION

Flow sensor:	Bi-directional digital turbine
Flow range:	±16L/s - ±3% or 50 mL
Dynamic resistance:	<0.5 cm H <sub>2</sub> O/L/s
Measured parameters:	Flow accuracy: ±5% or 200 mL/s
	Temperature sensor: Semiconductor (0-45°C)
	Reading on spirometer: FVC, FEV1, PEF, FEF 25/75
	Reading on PC with Winspiro PRO: same parameters as Spirobank G
SpO <sub>2</sub> range:	0-100% ±2% (50-100% SpO <sub>2</sub> )
Pulse rate range:	20-254 BPM ±2BPM or 2%
Data transmission:	USB 2.0 or Bluetooth
Memory capacity:	Up to 10,000 tests - 300 hours oximetry (only with 33473)
Power supply:	Lithium-ion 3.7 V, 1100 mAh rechargeable, for 40 hours measurements

## DISPOSABLE AND RE-USABLE TURBINES FOR MIR SPIROMETERS

- 33507 DISPOSABLE TURBINE WITH INTEGRATED MOUTHPIECE - box of 60
- Single patient use. Low cost and high accuracy. Individually packed to guarantee maximum hygiene. Easy to replace, no calibration needed. Compatible with GIMA codes: 33509, 33511-14, 33518-22, 33527-29, 33530, 33532, 33534.
- 33526 RE-USABLE TURBINE - bayonet
- Easy to replace, no calibration needed. Compatible with GIMA codes: 33511-14, 33518, 33520-22, 33528-32, 33534.



## MOUTHPIECES FOR MOST SPIROMETER BRANDS

Paper mouthpieces (disposable) and plastic mouthpieces (re-usable for most brands of spirometers and peak flow. Paper mouthpieces are packed in individual transparent pouch.



GIMA PAPER MOUTHPIECES					
GIMA code	Sizes - cm Ø int x ext x h	Suitable for	Compatibility GIMA codes	Other brands	Minimum order
33410	2.8x3x6.5	adult	33431, 33433, 33471-2, 33512-14, 33518-22, 33528-32, 33534	Micromedical Vitalograph, Mir	box of 500
33897				Ferraris (Koko legend) Cardiette (Pneumos 300)	dispenser of 100
33411	2.0x2.2x6	paediatric		Micromedical Vitalograph, Mir	box of 250
33412	Plastic adapter		33411	Mir	-
33506	2.6x2.8x6.5	adult	33480, 33484-7	Sibel	box of 100
33494	1.9x2.1x7	paediatric	33486, 33487	Sibel*	box of 100
33890	2.5x2.7x7	adult	-	Fukuda Sangjo, Thor	dispenser of 100
33892	2.8x3.05x7	adult	-	Cosmed (Pony model)	dispenser of 100
33898	2.8x3.05x7	adult	-	Cosmed (Pony model)	box of 500
33895	3.03x3.3	adult	-	Sensormedics, Microcard	box of 500
33899	2.42x2.6	adult	-	Sorin Lifewatch, Fukuda Denshi	box of 500
GIMA PLASTIC MOUTHPIECES					
33432	1.7x2.1x5 2.7x3x5	adult/ped	33431, 33433	Ferraris	-
33691		adult	33682-4, 6, 8	Thor	box of 10

\*Gimaspir A/B need adapter 33495

## SPIROMETRY PAPERS

- 33492 MIR SPIROLAB PAPER - roll 112mm x 25m
- Suitable also for SIBEL DATOSPIR 120 B, C, D, DATOSPIR Touch and GIMASPIR 120 models B, C, D.
- 33893 COSMED PONY PAPER - roll 57 mm x 11 m - box of 5 rolls
  - 33894 COSMED PONY FX PAPER - roll 112 mm x 13m - box of 25 rolls
- Compatible also with Fukuda Spirosift.
- 33250 THERMAL PAPER - roll 58 mm
- Suitable for SIBEL DATOSPIR 120 A and GIMASPIR 120-A.

## NOSECLIP

- 33474 NOSE CLIP

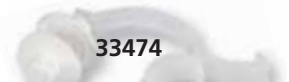

## BACTERIAL FILTER

- 33525 BACTERIAL FILTER - box of 50 for MIR, Medisoft spirometers
- 33557 SPIROGUARD BACTERIAL FILTER - box of 50

Compatibility of Spiroguard

Erich Jaeger GmbH	Masterlab and Masterscreen
Ferraris Medical - P.K. Morgan	Autolink-Benchmark Transflo and USA Transfer System
Sensormedics	2200 - 2400 - 2450
Vitalograph	Wedge-Bellow-Alpha and Escort Spirometers

## BACTERIAL FILTER - MOUTHPIECE FOR MOST SPIROMETER BRANDS



**BACTERIAL FILTER - MOUTHPIECE**  
Disposable filter with anatomical shape to prevent bacterial and viral contamination. Easy to use, direct connection to spirometer one side, patient mouthpiece other side. Suitable for most of spirometers and devices. Class II A. Individually packed in transparent bag. Made in Italy.

BACTERIAL FILTERS - MOUTHPIECES - box of 100				
GIMA code	Size - cm Ø int x ext	Compatibility with		
		GIMA codes	Other brands	
33884	2.75x3	33341, 33433, 33471-2, 33509-14, 33518-22, 33528-32, 33534	Micromedical, Vitalograph, Mir, Ferraris (koko legend), Cardiette (Pneumos 300)	
33885	2.75x3.1	-	Cosmed	
33886	2.95x3.4	-	Customed, Jaeger	
33887	3.05x3.5	-	Sensormedics, BTL, Thor, Morgan, Chest, Microgard	
33888	3.4x3.6	-	Medical Graphics	
33889	2.5x2.7	-	Fukuda Sangjo	

## SMART ONE PEAK FLOW-FEV1

• **33681 SMART ONE® - Peak Flow and FEV1** *Manual in GB, FR, IT, ES, DE, PT, PL, RU, TR, CN*  
 Ideal for monitoring respiratory illnesses

and in self management of Asthma, COPD, lung transplant care, cystic fibrosis and for use in clinical trials.

**Peak flow and FEV1 on your smartphone**  
 Simple handheld wireless device that can be easily connected via Bluetooth to iOS and Android smartphones and tablets.

**App (GB, IT) with an exclusive incentive for adult and children** based on exhaled flow and volume that gives accurate and helpful results. **Graphic trend of Peak Flow and FEV1**  
 Measurements including option to flag any test session. Test results history with Peak Flow, traffic light health indicator, symptoms scoring and notes. Low battery consumption.

**New turbine flowmeter with plastic mouthpiece**  
 For personal use, easy to remove for cleaning and hygienic. Made in Italy.

- **33896 REUSABLE MOUTHPIECE - plastic - box of 10**
- **33897 DISPOSABLE MOUTHPIECE - paper - box of 100**



CE 0476  
 FDA 510 (K)  
 Health Canada

33681

MIR



*Graphic trends of Peak Flow and FEV1 which can be shared by email*



TECHNICAL SPECIFICATION	
<b>General</b>	
Power supply:	2 batteries AAA 1.5 V included
Autonomy:	1,000 tests
Connectivity:	Low energy Bluetooth® 4.0
Size - weight:	49x109x21 mm - 61 g (batteries included)
Mouthpieces:	Ø 30 mm (1.18 inch)
<b>Spirometry</b>	
Flow sensor:	bi-directional digital turbine
Flow range:	±16 L/s Flow accuracy: ±5% or 200 mL/s
Volume accuracy:	±3% or 50 ml
Measured parameters:	FEV1, PEF
Memory capacity:	the application on the smartphone memorizes data

## PEAK FLOW METERS

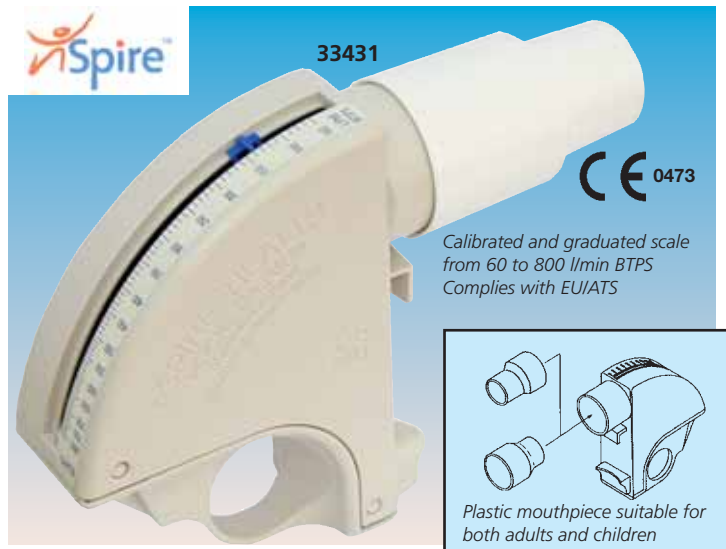

33431

CE 0473

*Calibrated and graduated scale from 60 to 800 l/min BTPS Complies with EU/ATS*

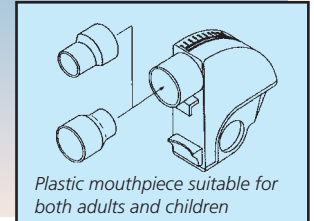

*Plastic mouthpiece suitable for both adults and children*

- **33431 POCKET PEAK - standard 60-800 l/min - cream**
  - **33433 POCKET PEAK - low 50-400 l/min - yellow**
- The Pocketpeak Peak Flow Meter is designed to provide simple and reliable home asthma management. Lightweight and easy to use, it provides accurate and reliable measurements over time.

It is easy to clean and features a universal mouthpiece. The EU/ATS Scale Pocket peaks will not only comply with the new European Standards but also with ATS (American Thoracic Society) Standards.

Standards range pocket peak will cover 60-800 litres/min, low range will cover 50/400 litres/min. Package includes multilingual directions for use and peak flow diary, all packed in a cardboard box. Made in USA. Size 86x81x30 mm.

Weight 45 g. Standards: EN 13826:2003

- **33432 UNIVERSAL MOUTHPIECES - re-usable**  
 In plastic, sterilizable, suitable both for adults and children.
- **33410 DISPOSABLE MOUTHPIECES - box of 500**

## LUNG EXERCISE DEVICE



CE

600 cc per sec  
 900 cc per sec  
 1200 cc per sec

*Base and small balls made in non-toxic polypropylene. Central part made in copolymer/non-toxic polystyrene. Tube and mouthpiece made in polyethylene.*

33442

- **33442 RESPIPROGRAM**

Device to exercise the respiration through inspiration. The respiratory-exerciser Respirogram helps the patient to recover the normal respiration after a chest or abdominal surgery. The device is composed of: 1 base, 3 small balls different in dimension and colours, 1 transparent central part divided into 3 rooms, 1 tube and mouthpiece. Each unit packed in single box. Made in Italy. User manual: GB, IT.

- **33445 TRI-BALL® - respiratory exerciser**

The respiratory-exerciser Tri-Ball® helps the patient to recover the normal respiration after a chest or abdominal surgery. Single patient. User manual in GB, FR, DE, IT, ES.



33445

600/900/1200 cc per sec

## AEROSOL HOLDING CHAMBER



Spire

33438

*Designed to bring you the most effective drug delivery at the lowest cost of operation*

- **33438 POCKET CHAMBER**

Now you can manage your asthma conveniently and effectively with a truly pocket-sized device, proven as effective as MDI chambers nearly twice its size. The Pocket Chamber delivers a high concentration of respirable aerosol, to help provide relief from asthma symptoms while capturing large particles and reducing unwanted side-effects.

- whistle alerts patients if inspiratory rate is exceeded
- effective, affordable alternative to expensive aerosol delivery
- flexible port accepts virtually any MDI's mouthpiece

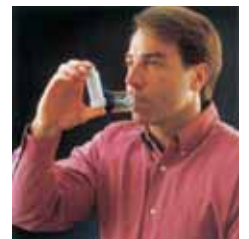

### TECHNICAL SPECIFICATION

Size: 108 x 47.5 mm	Volume: 110 ml
Mouthpiece: 22 mm external Ø	Weight: 33 g
Materials: All Latex Free Silicone	Warranty: One year
User Manual: GB, FR, IT, ES, DE, PT, NL, GR, TR	Made in USA

## SPIROBANK II SMART - PORTABLE SPIROMETER WITH SPO<sub>2</sub> OPTION

• **33512 SPIROBANK II SMART + WINSPIROPRO SOFTWARE**  
Spirometer with 10.000 tests memory capacity, monochromatic LCD display, 6 keys membrane keypad. Battery power supply (3,7 V-1100 mA lithium) with an autonomy of approx. 50 hours of continuous use, rechargeable with USB port.  
- cable (USB 2.0) or wireless (Bluetooth 4.0) connection  
- internal temperature sensor for automatic BTPS conversion  
- high resolution graphic display  
- automatic record of a whole spirometry session including best test  
- USB cable, carrying case, CD manual (GB, FR, IT, ES, DE, PT) re-usable turbine and software included. Selectable internal software (GB, FR, IT, ES, DE, PT)

• **33514 SPIROBANK II SMART + WINSPIROPRO SOFTWARE + OXYMETER**

Same as above with more than 300 hours of oximetric test records (SpO<sub>2</sub> % and pulse frequency tests).  
Measured parameters: min, max and average SpO<sub>2</sub> %, min, max and average pulse frequency, SpO<sub>2</sub> total events, test duration, bradycardia events (<40 BPM), tachycardia events (>120 BPM), T90% (time passed with SpO<sub>2</sub> ≤89%), T89% (time passed with SpO<sub>2</sub> ≤ 88%)

- **33525 ANTIBACTERIAL FILTER - box of 50 disposable**
- **33507 DISPOSABLE TURBINE with mouthpiece - box of 60**
- **33526 REUSABLE TURBINE**
- **33410 MOUTHPIECES int. Ø 2.8 x ext. Ø 3, h 6.5 cm**

### TECHNICAL SPECIFICATIONS - SPIROMETRY

Measured parameters FVC, FEV1, FEV1/FVC%, DTPEF, FEV 0.5, FEV0.5/FVC%, FEV0.75, FEV0.75/FVC%, FEV2, FEV2/FVC%, FEV3, FEV3/FVC%, FEV6, FEV1/FEV6%, PEF, FEF25%, FEF50%, FEF75%, FEF25-75%, FEF75-85%, FET, Vext, Lung Age, EVOL, FVC, FIV1, PIF, FIV1/FIVC%, FIF25%, FIF50%, FIF75%, R50, PIF, IRV, VC, IVC, IC, ERV, FEV1/VC%, VT, VE, Rf, ti, te, ti/t-tot, VT/ti, MVV	Flow sensor bi-directional digital turbine Flow range ±16L/s Volume accuracy ±3% or 50 mL Flow accuracy ±5% or 200 mL/s Dynamic resistance <0.5 cm H <sub>2</sub> O/l/s Available tests: FVC, VC, IVC, MVV, PRE - POST Connectivity USB 2.0, Bluetooth® 4.0 Power supply Lithium-Ion 3.7V, 1100 mAh
---	--

### TECHNICAL SPECIFICATIONS - OXIMETRY (33514 only)

Measurement method: red and infrared absorption SpO <sub>2</sub> range: 0-99% ±2 % between 70-99% SpO <sub>2</sub> Pulse rate range: 18-300 BPM ±2 BPM or 2%	Signal quality indicator: 0-8 segments on display Memory capacity: up to 300 hours oximetry
--	--

**WinspiroPRO software functions:**  
(GB, FR, IT, DE, ES, PT, PL, SE, NL, LV, CZ, TR, RU, CN, JP)  
- on-line PC connection with icon interface  
- real time Flow/Volume and Volume/time curves  
- bronchial challenge with FEV1 dose-response  
- paediatric incentive animations  
- integration with EPR systems  
- Lung Age Estimation  
- data and graphs export also via e-mail

PC system requirements:  
XP, Seven, Vista, 8, 10

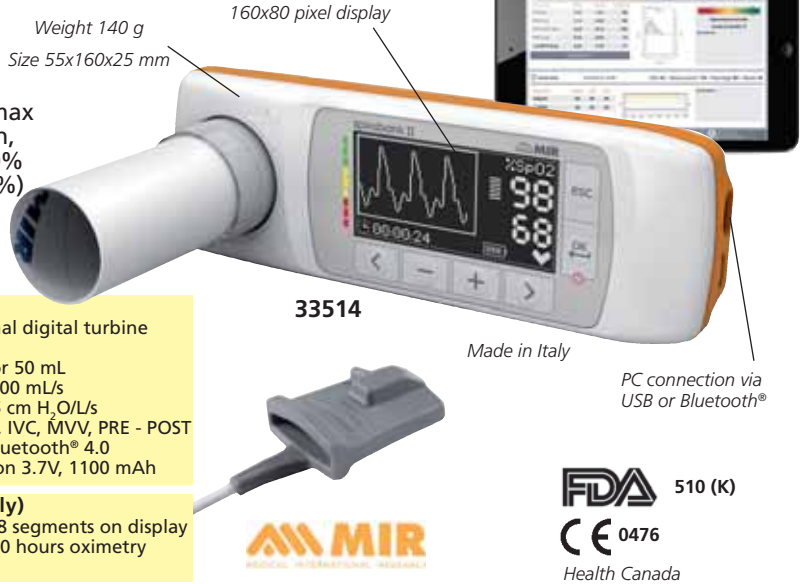

FDA 510 (K)  
CE 0476  
Health Canada

## SPIROBANK II BASIC



System requirements: Microsoft Windows Vista, 2000, XP, ME, Seven, 8, 10

• **33510 SPIROBANK II BASIC + WINSPIROPRO software**  
Complete and rapid pocket spirometer for the General Practitioner to carry out spirometry testing anywhere.  
**No calibration required, use disposable turbine FlowMIR with integrated mouthpiece (33507) or reusable turbine (33526).**  
- measures the most important spirometric parameters including: FVC, VC, IVC, IC, ERV, FEV1, FEV1%, PEF, FEF 25-75, FET, EVOL, TEST POST BD

- traffic lights for immediate test interpretation
- memory up to **10,000 tests**
- rechargeable **long life battery** (40 hours continuous operation)
- real time tests via **USB**
- selectable display language and CD manual (GB, IT, ES, FR, DE, PT)

Supplied with Winspiro PRO software, USB cable, 1 disposable turbine in a carrying bag.

- **33507 FLOWMIR DISPOSABLE TURBINE with integrated mouthpiece - box of 60 - spare**
- **33526 REUSABLE TURBINE - optional**

### TECHNICAL SPECIFICATION

Power supply: 3.7 V, 110 mA lithium battery, USB rechargeable	Display: LCD monochrome 160x80 pixel
Keypad: 6-key membrane keyboard	Flow accuracy: ± 5% or 200 ml/s whichever is greater
Flow range: + 16 l/s	Volume accuracy: ± 3% or 50 ml whichever is greater
Max volume: 10 l	Data transmission: USB 2.0
	Made in Italy

## SPIROBANK G WITH SOFTWARE



• **33518 SPIROBANK G + WINSPIROPRO software**  
- stand alone spirometer with PC online operation  
- 6,000 spirometry in memory  
- high legibility graphic display  
- FVC, VC, IVC, MVV, PRE-POST BD  
- advanced spirometry test interpretation  
- Lung Age Estimation (ELA)  
- ready for **Telemedicine** applications  
- internal temperature sensor for automatic BTPS  
- upgradable internal software via internet  
Standard package includes USB cable, pouch, noseclip, battery, re-usable turbine and Winspiro PRO software.

### TECHNICAL SPECIFICATION

Measured parameters: FVC, FEV1, FEV1/FVC%, FEV3, FEV3/FVC%, FEV6, FEV1/FEV6%, PEF, FEF25%, FEF50%, FEF75%, FEF25-75%, FET, Vext, Lung Age, FVC, FIV1, FIV1/FIVC%, PIF, VC, IVC, IC, ERV, FEV1/VC%, VT, VE, Rf, ti, te, ti/t-tot, VT/ti, MVV	Temperature sensor: semiconductor (0-45 °C)
Flow sensor: bi-directional digital turbine	Max volume: 10 l
Flow range: ± 16 l/s	Volume accuracy: ± 3% or 50 ml, whichever is greater
Flow accuracy: ± 5% or 200 ml/s, whichever is greater	Dynamic resistance at 12 l/s: <0.5 cm H <sub>2</sub> O/l/s
Power supply: 9V DC (PP3 battery)	Weight: 180 g (with battery)
Dimensions: 162x49x32 mm	Made in Italy
<b>WinspiroPRO PC system requirements</b> (GB, FR, IT, DE, ES, PT, PL, SE, NL, LV, CZ, TR, RU, CN, JP) - Microsoft Windows: Vista, 2000, XP, Me, Seven, 8 - Screen resolution: 1024x768	- Hard disk space: 160 MB

Supplied with CD manual (GB, FR, IT, ES, DE, PT) Internal software (GB, FR, IT, ES, DE, PT, PL)

# SPIRODOC® - SPIROMETER AND OXIMETER

- 33532 SPIRODOC SPIROMETER + SOFTWARE WINSPIRO PRO - bluetooth
- 33533 SPIRODOC OXIMETER + SOFTWARE WINSPIRO PRO
- 33534 SPIRODOC SPIROMETER + OXIMETER + SOFTWARE - bluetooth

One touch laboratory for respiratory analysis suitable for professional and personal use.

### Complete spirometer ATS/ERS compliant

Specialist-level analysis, screening and Home-care monitoring. It has been developed with various operation modes:

“advanced” parameters for the specialist, “reduced” set of parameters for screening as well as a “simplified” version for Home-care operation. FVC, VC, IVC, MVV, PRE-POST.

Precise spirometry interpretation including post bronchodilator. All tests are automatically memorized. Automatic BTPS conversion. Memory capacity: 10.000 tests. Wide selection of predicted values.

### Intelligent pulse oximeter with on-screen results

Simple, clear SpO<sub>2</sub> and Pulse Rate measurements with plethysmographic curve. During the single six-minute walk test (6 MWT), Spirodoc® estimates the level of oxygen therapy required by the patient. Spirodoc® carries out sleep desaturation studies and memorizes events as well as body position.

### 3D Accelerometer with motion analysis

Spirodoc® is the first 3D Oximeter® incorporating a triaxial motion sensor to correlate the saturation level (%SpO<sub>2</sub>) with physical activity (walk counter, movement analysis and VMU).

### Home-care symptoms diary

Fast on-screen symptoms entry. Touch screen with settable questions and automatic answer recording for homecare patient use (eDiary).

### High performance PC software for spirometry and oximetry

All tests memorized in Spirodoc® are automatically downloaded into WinspiroPRO and a patient data card is created with a preview of the spirometry curve. WinspiroPRO can easily be connected to a database, EPR, hospital or occupational health system. This software also gives trend graphs of any parameter. All stored tests and curves of every patient can be reviewed on a single page

Internal software and CD manual: GB, FR, IT, ES, DE, PT (only manual)

**SPIROMETER + OXIMETER + 3D ACCELEROMETER IN ONE UNIT**



33534

Easy touch-screen display



Three phase report of 6 minutes walk test: baseline, walk, recovery

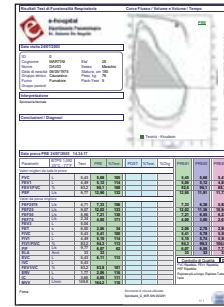

Spirometry report

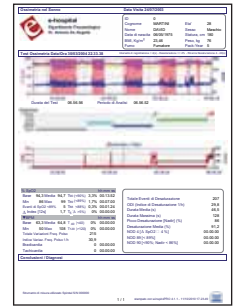

Nocturnal oximetry report with desaturation analysis

and the results, including oximetry tests, can be compared. Supplied with reusable turbine. Multilanguage software: GB, FR, IT, ES, DE, PT, PL, NL SE, CZ, LV, TR, RU, CN, JP.

### TECHNICAL SPECIFICATIONS

#### Central unit

Display: LCD backlit touch screen display 128x64 pixels  
 Power supply: Lithium ion 3.7 V, 1100 mA rechargeable battery with 50 hours measurement back up  
 Accelerometer: Triaxial ±2 g, 400 Hz sampling  
 Dimension and weight: central unit 101x48x16 mm, 99 g removable turbine head: 46x47x24 mm, 17 g  
**Spirometry**  
 Flow sensor: Bi-directional digital turbine  
 Flow range: ±16 L/s  
 Volume accuracy: ±3% or 50 mL, whichever is greater  
 Flow accuracy: ±5% or 200 mL, whichever is greater  
 Dynamic resistance at 12 L/s: <0.5 cm H<sub>2</sub>O/L/s

Temperature sensor: semiconductor (0-45°C)

#### Spirometer measured parameters

FVC, FEV1, FEV1/FVC%, FEV3, FEV3/FVC%, FEV6, FEV1/FEV6%, PEF, FEF25%, FEF50%, FEF75%, FEF25%-75%, FET, Estimated Lung Age, Extr. Vol., FIVC, FIV1, FIV1/FIVC%, PIF, VC, IVC, IC, ERV, FEV1/VC%, VT, VE, Rf, ti, te, ti/t-tot, VT/ti, MW measured, MW calculated

#### Oximetry

SpO<sub>2</sub> range: 0-100%, ±2% (50-100% SpO<sub>2</sub>)

Pulse rate range: 20-254 BPM, ±2 BPM or 2%

#### Pulseoximeter measured parameters

SpO<sub>2</sub> [Baseline, Min, Max, Mean], Pulse rate [Baseline,

Min, Max, Mean], T90% [SpO<sub>2</sub><90%], T89% [SpO<sub>2</sub><89%], T88% [SpO<sub>2</sub><88%], T5% [ΔSpO<sub>2</sub>>5%], ΔIndex [12s], SpO<sub>2</sub> events, Pulse rate events [Bradycardia, Tachycardia], Step counter, Movement [VMU], Recording time, Analysis time

#### Sleep analysis

Body position, SpO<sub>2</sub> events, Desaturation index (ODI), Desaturation [Mean Value, Mean duration, Longest duration, Nadir Peak], ΔSpO<sub>2</sub> [Min Drop, Max Drop], Total Pulse Variations, Pulse Rate Index, NOD89% [SpO<sub>2</sub><89%; >5min], NOD4% [SpO<sub>2</sub> Basale-4%; >5min], NOD90% [SpO<sub>2</sub><90%; Nadir<86%; >5min]

# MINISPIR® LIGHT

• 33527 MINISPIR with Winspiro Light  
 Minispir Light measures 10 essential parameters for a diagnostic spirometry: FEV6, FVC, FEV1, FEV1%, PEF, FEF25/75%, FIVC, Lung Age, VC, IVC. Pediatric incentives. Flow/Volume loop and Volume/Time curve. Spirometry test interpretation. Temperature sensor for BTPS conversion. Minispir Light meets the requirements of integrated healthcare platforms and tablet applications. For use with FlowMir disposable turbine only (33507). Winspiro Light is an intuitive and efficient software, for complete diagnosis included in Minispir Light.

**FOR ESSENTIAL RESPIRATORY TESTING**

# AND MINISPIR®-USB

• 33528 MINISPIR with Winspiro PRO  
 • 33529 MINISPIR+OXYMETER with Winspiro PRO  
 Real time Flow/Volume loop and Volume/time curve with PRE/POST comparison. Advanced spirometry test interpretation. Pediatric incentive animations. Lung Age. Bronchial provocation test including new Mannitol protocol with FEV1 response curve. Temperature sensor for BTPS conversion. Supplied with reusable turbine.

**FOR COMPLETE RESPIRATORY ANALYSIS**

### 32 measured parameters: FVC, FEV1, FEV1%, FEV3, FEV3%, FEV6, FEV1/FEV6%, PEF, FEF25%, FEF50%, FEF75%, FEF25-75%, FET, Vext, Lung Age, FIVC, FIV1, FIV1%, PIF, VC, IVC, IC, ERV, FEV1/VC%, VT, VE, Rf, ti, te, ti/t-tot, VT/ti, MVV.

CD manual GB, FR, IT, ES, DE, PT.  
**Winspiro PRO** is a unique spirometry and oximetry software, which comes standard with Minispir. All patient records are shown on simple, single-screen patient cards with dynamic management of all data and graphs.

### PC SYSTEM REQUIREMENTS FOR WINSPIRO LIGHT/PRO

Microsoft Windows: XP, Vista 32/64 bit, Seven 32/64 bit, 8  
 Screen resolution: 1024x768 Hard disk: 128 MB (better 256 MB)  
 USB socket  
 Multilanguage: GB, FR, IT, ES, PT, DE, PL, SE, NL, CZ, LV, TR, RU, CN, JP

33529 PC not included

### TECHNICAL SPECIFICATIONS MINISPIR/MINISPIR LIGHT

Temperature sensor: semiconductor (0-45°C)  
 Flow sensor: bi-directional digital turbine  
 Flow range: ± 16 L/s  
 Volume accuracy: ± 3% or 50 mL  
 Flow accuracy: ± 5% or 200 mL/s  
 Dynamic resistance at 12 L/s: <0.5 cm H<sub>2</sub>O/L/s  
 Communication port: USB  
 Power Supply: line powered from USB port  
 Dimension: 50x142x26 mm  
 Weight: 65 g

### TECHNICAL SPECIFICATIONS MINISPIR SpO<sub>2</sub>

SpO<sub>2</sub> range: 0-99%  
 SpO<sub>2</sub> accuracy: ± 2% tra 70-99% SpO<sub>2</sub>  
 Pulse Rate range: 30-300 BPM  
 Pulse Rate accuracy: ± 2 BPM or 2%  
**Measured parameters**  
 SpO<sub>2</sub> [Baseline, Min, Max, Mean], Pulse Rate [Baseline, Min, Max, Mean], T90 [SpO<sub>2</sub><90%], T89 [SpO<sub>2</sub><89%], T88 [SpO<sub>2</sub><88%], T5 [ΔSpO<sub>2</sub>>5%], Δ Index [12s], SpO<sub>2</sub> Events, Pulse Rate Events [Bradycardia, Tachycardia]

GIMA code	SPARE PARTS AND ACCESSORIES
33507	Flowmir disposable turbine with integrated mouthpiece - box of 60
33410	Adult mouthpieces Ø ext 3 cm - box of 500 pieces (only for 33526)
33526	Reusable turbine (only for 33528-9)

# SPIROLAB III - DIAGNOSTIC SPIROMETER WITH SPO<sub>2</sub> OPTION



LCD Colour display  
240x320 pixel,  
size 90x120 mm

Printer

PEDIATRIC INCENTIVE SYSTEM

HIGH DEFINITION LCD

DATABASE FOR 6,000 TESTS

USB

ATS Certified

ERS Standard

Mini flowmeter

• 33521 SPIROLAB III - diagnostic spirometer with high resolution colour display, built-in printer and PC WINSPIROPRO software

• 33522 SPIROLAB III same as 33521 with SpO<sub>2</sub>

A really complete spirometry system:

- FVC, VC with breathing pattern plus MVV tests with real time curves
- over 30 parameters with **automatic interpretation** and test quality control
- PRE/POST bronchial response protocol with F/V loop comparison
- up to 8 blows curve on one screen
- internal database for about 6,000 complete tests
- predicted values with various authors
- rechargeable battery plus mains power 220 V, 50-60 Hz (110V on request)
- user-friendly keyboard with dedicated function keys plus alphanumeric data entry
- internal temperature sensor for automatic BTPS conversion
- free upgradable internal software from web, maintaining previously stored data
- selectable multilanguage internal software (GB, FR, IT). Possibility to order also with following internal languages: DE, ES, PL, PT, RU, CN, TR.

**Finger Oximeter (33522 only)**

- short or long term (overnight) SpO<sub>2</sub> and Pulse Rate measurements
- ODI, NOD, T90%, T89%, T88, T87%
- oximetry during exercise test

• 33410 ADULT MOUTHPIECES - Ø 3 cm ext - box of 500 pcs.

• 33492 THERMAL PAPER - 112 mm x 25 m

• 33515 SpO<sub>2</sub> PROBE - adult - spare

• 33516 SpO<sub>2</sub> PROBE - paediatric

• 33525 ANTIBACTERIAL FILTER - disposable - box of 50 pcs.

• 33507 DISPOSABLE TURBINE WITH INTEGRATED MOUTHPIECE - box of 60

• 33524 CONNECTION CABLE MINIFLOWER-SPIROLAB III (532370) - spare

• 33523 CONNECTION CABLE MINIFLOWER-SPIROLAB and SPIROLAB II (532375) - spare

33521, 33522 Connection cable (33523-4)

Only 1.9 kg for truly portability

WinspiroPRO software included (GB, FR, IT, DE, ES, PT, CZ, SE, NL, PL, LV, TR, RU, CN, JP)

SpO<sub>2</sub> probe included with 33522

Quality spirometry, precise measurement  
The proven MIR digital turbine flow sensor requires **no calibration** and complies with ATS 24/26 waveforms.

Certified by Dr. Crapo at LDS Hospital, Salt Lake City - Utah



### TECHNICAL SPECIFICATIONS 33521-33522

Flow/volume range:	± 16 l/s
Volume accuracy:	±3% or 50 ml
Flow accuracy:	±5% or 200 ml/s
Dynamic resistance:	<0.8 cm H <sub>2</sub> O/l/s
Dimensions:	310x205x65 mm
Parameters:	FVC, FEV1, FEV1/FVC%, FEV3, FEV3/FVC%, FEV6, FEV1/FEV6%, PEF, FEF25-75%, FEF25%, FEF50%, FEF75%, FET, Vext, *FVC, *FEV1, *PEF, PIF, FIVC, FIV1, FIV1/FIVC%, VC, IVC, ERV, IC, FEV/VC%, VT, VE, Rf, Ti, Te, Ti/T-tot, VT/Ti, MVV * : Best value
PC System requirements:	Windows 2000, ME, XP, Seven, Vista, 8.
Made in Italy.	

### STANDARD ACCESSORIES

Carrying case	Software Winspiro PRO.	Nose clip
Battery charger	USB port and cable	Reusable turbine (33526)
1 roll thermal paper	CD manual: GB, FR, IT, ES, DE, PT	

# SP-10 POCKET SPIROMETER



AVAILABLE WITH BLUETOOTH

33536

• 33536 SP-10 POCKET SPIROMETER

• 33535 SP-10 POCKET SPIROMETER WITH BLUETOOTH

Pocket, portable spirometer with large TFT screen to clearly display both numbers and flow charts.

Synchronously measure FVC, PEF, FEV1, FEV1%, FEF25, FEF2575, FEF75.

Support diagnosis evidence by volume and flow rate chart display. Built-in predicted values.

Built-in lithium rechargeable battery and battery power display. Supplied with USB cable for PC connection, battery charger and software to calculate data and analyse trend.

• 33410 ADULT MOUTHPIECES - Ø 3 cm ext. - box of 500 pcs

### TECHNICAL SPECIFICATIONS

Max volume:	10 l
Flow range:	2 l/sec - 16 l/sec
Volume accuracy:	±3% or 50 ml whichever is greater
Flow accuracy:	±5% or 200 ml/sec whichever is greater
Parameters:	FVC, FEV1, PEF, FEV1%, FEV25, FEF2575, FEF75
Made in PRC	
CE 92/42 - EMC group I class B - protection type BF	

### STANDARD ACCESSORIES

- Internal lithium battery
- USB cable
- PC software (english language)
- User manual: GB, IT, ES.



# SPIROLAB SPIROMETER: 7" TOUCHSCREEN AND SPO<sub>2</sub> OPTION



Miniflowmeter for reusable and disposable turbine (Ø 30 mm)

CE 0476  
 FDA 510 (K)  
 Health Canada

- 7" TOUCHSCREEN DISPLAY
- PEDIATRIC INCENTIVE SYSTEM
- DATABASE FOR 10,000 TESTS
- USB 2.0, BLUETOOTH 2.1

33519

- 33519 SPIROLAB® SPIROMETER WITH 7" TOUCHSCREEN
  - 33520 SPIROLAB® SPIROMETER WITH 7" TOUCHSCREEN AND SpO<sub>2</sub>
- Fast, simple, durable diagnostic spirometer, made in Italy.

**Unbeatable features**

- FVC, VC, MVV, PRE/POST Bronchodilator comparison with a wide range of selectable parameters
- long life rechargeable battery
- colour Touchscreen 7" display
- direct connection to external USB Printer PostScript
- 10,000 Spirometry tests or 500 hours of oximetry recording
- wireless Real Time test on PC via Bluetooth®
- fast and silent built-in B/W printer with customizable printout format

- selectable internal software languages: GB, FR, IT, ES, DE, PT  
**Oximetry option**

Available adult and pediatric reusable finger probe.

**Fast and user friendly**

Each function can be activated by a simple touch.

**FlowMIR® disposable turbine - complies with ATS/ERS standard**  
 Totally disposable (mouthpiece, turbine) guarantees 100% hygiene, no cross contamination. No calibration required.  
 Suitable also for pediatric use without need of adaptor.



Each turbine is factory calibrated with a computerized system and is individually packaged in a clean room

33507

**Suitable for children**

Patented pediatric incentive directly on the screen.



**WinspiroPRO®**

High performances PC software for spirometry and oximetry with free update. Multilanguage software: GB, FR, IT, ES, DE, PT, PL, NL, LV, SE, CZ, RU, TR, JP, CN.



Summary of all tests carried out



Printout: spirometry report

**STANDARD ACCESSORIES**

- |                      |  |
|----------------------|--|
| Carrying case        | Software WinspiroPRO®                      |
| Battery charger      | USB port and cable                         |
| 1 roll thermal paper | SpO <sub>2</sub> adult sensor (33520 only) |
| Reusable turbine     | CD manual: GB, FR, IT, ES, DE, PT          |
| Nose clip            |  |



**TECHNICAL SPECIFICATIONS - SPIROMETRY**

- |                        |   |
|------------------------|---|
| Power supply:          | Rechargeable battery  |
| Autonomy:              | approx. 10 hours  |
| Temperature sensor:    | semiconductor (0-45°C)  |
| Flow sensor:           | bi-directional digital turbine  |
| Flow range:            | ±16L/s  |
| Volume accuracy:       | ±3% or 50mL   |
| Flow accuracy:         | ±5% or 200mL/s  |
| Dynamic resistance:    | <0.5 cm H <sub>2</sub> O/L/s  |
| Connectivity:          | USB 2.0, Bluetooth® 2.1   |
| Display:               | 7" colour touch screen LCD, 800x480 resolution                                      |
| Mouthpieces:           | Ø 30 mm (1.18 inch)   |
| Dimensions:            | 220x210x51 mm (8,66x8,26x2")  |
| Weight:                | 1450 g (battery pack included) (3,1lb)  |
| Electrical protection: | Class II  |
| Norms:                 | Electrical safety standard EN 60601-1<br>Electromagnetic compatibility EN 60601-1-2 |

**SPIROMETRY PARAMETERS**

FVC, FEV1, FEV1/FVC, PEV, FEF25, FEF50, FEF75, FEF25-75, FEF75-85, Lung Age, Extrapolated Volume, FET, Time to PEF, FEV0.5, FEV0.5/FVC, FEV0.75, FEV0.75/FVC, FEV2, FEV2/FVC, FEV3, FEV3/FVC, FEV6, FEV1/FEV6, FEV1/PEF, FEV1/FEV0.5, FIVC, FIV1, FIV1/FIVC, PIF, FIF25, FIF50, FIF75, FEF50/FIF50, VC, IVC, IC, ERV, IRV, Rf, VE, VT, tl, tE, VT/tl, tE/tTOT, MVV (measured), MVV (calculated).

**WINSPIROPRO® REQUIREMENTS**

Windows 2000, Xp, Vista (32/64 bit), 7 (32/64 bit), 8 and 8.1 (32/64 bit), 10 (32/64 bit). RAM 512 MB

GIMA code	MIR code	ACCESSORIES AND SPARES	Minimum order
33695	919024	SpO <sub>2</sub> probe - adult - spare	
33696	939006 + 919200	SpO <sub>2</sub> probe - paediatric	
33697	910595	Miniflowmeter with cable - spare	
33410	-	Adult mouthpiece - Ø 30 mm ext	box of 500
33492	-	Thermal paper - 112 mm x 25 m	-
33525	-	Antibacterial filter - disposable	box of 50
33507	910004	Disposable turbine with integrated mouthpiece	box of 60

**TECHNICAL SPECIFICATIONS - OXIMETRY (33520 only)**

- SpO<sub>2</sub> range: 0-99%
- SpO<sub>2</sub> accuracy: ± 2% between 70-99% SpO<sub>2</sub>
- Pulse Rate range: 18-300 BPM
- Pulse Rate accuracy: ± 2BPM or 2% whichever is greater
- Memory capacity: up to 500 hours oximetry

**OXIMETRY PARAMETERS (33520 only)**

%SpO<sub>2</sub> and Pulse Rate (Min, Max, Average), Test duration, Total SpO<sub>2</sub> Events, T90% (SpO<sub>2</sub> time ≤89%), T89% (SpO<sub>2</sub> time ≤88%), T40 (Bradycardia duration with Pulse Rate <40 BPM), T120 (Tachycardia duration with Pulse Rate >120 BPM)

# ULTRASONIC, DISINFECTABLE SPIROMETERS

- 33682 OTTHON SPIROMETER US (English) + SOFTWARE
- 33683 OTTHON SPIROMETER IT + SOFTWARE
- 33684 OTTHON SPIROMETER OTHER LANGUAGES + SOFTWARE

Size: 35x120x120 mm  
Weight: 300 g

Pulmonary function diagnostics and monitoring spirometer for use by general practitioners, respiratory physicians and patients. Compact, mobile, affordable solution for screening COPD (Chronic Obstructive Pulmonary Disease) and asthma.

- automated diagnostic interpretation
- voice and video explain use of device and communicate results
- battery or USB charger
- touchscreen, bright colour high resolution LCD display QVGA (320x240 px), 16 M colours
- external printer connectivity
- automatic internal calibration
- flow tube disinfectable by cold sterilization
- power supply: USB 5 V or built in rechargeable battery

Internal software languages: GB, FR, IT, DE, ES, HU, AU, HR.  
Voice languages available: US (English), AU, FR, IT, DE, ES, AT, HU.  
Please indicate requested language with order.  
Made in Europe.

Size: 40x60x150 mm  
Weight: 300 g



**FVC, MW AND VC MEASUREMENT**

- 33686 SPIROTUBE MOBILE EDITION BLUETOOTH SPIROMETER

Pulmonary function diagnostics and monitoring spirometer with Bluetooth communication interface and built in rechargeable battery. Suitable for screening COPD and asthma.

- wireless connection to mobile phones, PDAs, android systems.
- Real-time measurement with FVC curve visible on the mobile screen
- plug & play USB connection to PC
- automatic internal calibration
- tele-medical connection via Bluetooth
- automated medical interpretation
- long-term monitoring for home care use
- pharmaceutical testing subsystem
- flow tube disinfectable by cold sterilization
- software can be freely downloaded from Google Play Store

Made in Europe.



*Spirotube mobile edition connects to Android based systems turning these devices into respiratory diagnostic stations*

- 33688 SPIROTUBE PC SPIROMETER + SOFTWARE
- 33689 SPIROTUBE B SHOCK AND WATER PROOF SPIROMETER + SOFTWARE

PC based pulmonary function diagnostics and monitoring spirometer with ultrasonic Idegen™ respiratory sensor. Suitable for screening COPD and asthma.

- automatic internal calibration
- tele-medical connection via internet
- plug & play USB PC connection detection
- easy upgrade, standard interfaces, XML, HL7
- long-term monitoring for life-long patient support
- pharmaceutical testing subsystem
- flow tube disinfectable by cold sterilization

### Spirotube B Edition for harsh conditions

Features an exceptionally robust design for harsh condition and heavy use.

Power supply: USB 5 V. Made in Europe.

Size: 27x60x150 mm  
Weight: 300 g



**WATER PROOF SHOCK PROOF**

STANDARD ACCESSORIES	33682/3/4	33686	33688
Thorsoft software	•	•	•
Plastic mouthpieces	•	•	•
Mini USB cable	•	•	•
Cups for disinfection	•	•	•
Battery charger	•	•	•
Bacterial filter	•	•	•
Carrying bag	•	•	•
Paper manual (GB)	•	•	•
CD manual (GB, IT, ES, DE, HU)	•	•	•

TECHNICAL SPECIFICATIONS	
Flow measurement principle	Idegen™ multiple-path
Flow tube diameter	30 mm (OD)
Dead space	16.8 ml
Flow resolution	3 ml/s (33686), 8 mb/s (33682-4, 33688)
Flow precision	2% (33686, 33688), 3% (33682-4)
Flow range	±18 l/s
Connection to PC	USB

MEASURED PARAMETERS	
FVC, -FEV*0.5, FEV*0.5/IVC, FEV*0.5/FVC, FEV*1.0/IVC, FEV*1.0/FVC, PEF, FEF*25-75%, MEF*75%, MEF*50%, MEF*25%, FET, MTT, FIVC, FIV*0.5, FEV1/FVC (Tiffeneau index) FIV*1.0, PIF, FIF*25-75%, IRV, ERV, TV, Breath rate value	- Insp./Expi ratio: From 1:10 to 10:1

### REGISTRATIONS

All spirometers are CE marked and registered in Indonesia, Singapore, Hong Kong, Australia, New Zealand, Korea, Saudi Arabia.

### THORSOFT - PULMONARY DIAGNOSTIC PC SOFTWARE

Standard medical interfaces (HL7, GDT, BDT, XML). Automatic interpretation module. Diagnostic decision support system (for general practitioners and physicians) Complete stress testing procedure Languages: GB, FR, IT, DE, ES, SE, TR, RO, HU, SL, CZ, HR, NL, KR, CN.



GIMA code	ACCESSORIES	Minimum order
33690	Instrumed disinfectant concentrate 1 l (Bactericidal, fungidal, virucidal, sporocidal, tuberculocidal)	
33691	Plastic mouthpieces	box of 10
33890	Disposable mouthpieces	box of 100
33692	Loki Green single use bacterial filter	box of 50
33505	Calibration syringe 3 l*	

\* Ultrasonic spirometers do not need calibration. Syringe is only for check if requested by law.

## SLEEP APNEA SCREEN METER

• **33676 SLEEP APNEA SCREEN METER**

Suitable for people who have obstructive sleep apnea-hypopnea syndrome (OSAHS), chronic obstructive pulmonary diseases (COPD), asthma, vascular disease or people over 60 years old. For hospital and home use.

Features:

- wrist-design, small in volume and light in weight
- integrate multi-function in one device, convenient to know more physiological information
- displays SpO<sub>2</sub>, PR, pulse sound, bar graph
- display of pulse and nasal airflow waveform
- alarm for low-power, finger-out and over-limit
- adjustable screen brightness
- real-time clock
- auto-power on/off
- multi-care record
- record data in continuous 20 hours
- upload data by USB to PC
- PC analysis software



33676

• **33677 RUBBER ADULT SpO<sub>2</sub> PROBE for day**

• **33678 NON-WOVEN SpO<sub>2</sub> PROBE for night - bag of 2**

• **34172 NASAL OXYGEN CANNULA**

**STANDARD ACCESSORIES**

- |   |                  |
|---|------------------|
| Adult, Neonatal disposable SpO <sub>2</sub> probe | Adapter          |
| Adult SpO <sub>2</sub> probe                      | USB cable        |
| Software  | Nose-oxygen tube |
| Manual (GB, IT)                                   |                  |



33676

CE 0123

**TECHNICAL SPECIFICATIONS**

Nasal airflow measure range:	0-40 rpm ± 2 rpm
SpO <sub>2</sub> measuring range:	0-100 % ± 2 (70-100 %), resolution 1%
Pulse Rate measuring range:	30-250 bpm ± 2 bpm or ± 2% (select the larger)
Resistance to surrounding light:	The difference between the value measured in the condition of man-made light and indoor natural light and that of darkroom is less than ± 1 %
Display:	1.8" colour OLED
Power consumption:	≤ 70 mA
Power supply:	3.7 V rechargeable lithium battery
Battery working hour:	continuously work for more than 20 hours
Safety Type:	Internally powered, Type BF applied part
Dimension of device:	69x50x17.3 mm
Weight:	100 g (lithium battery included)

## BREATHCARE PAP DEVICES: CPAP AND AUTO CPAP



53700

CE 0123



53701

- **53700 BREATHCARE PAP DEVICE - CPAP**
- **53701 BREATHCARE PAP DEVICE - CPAP/AUTO CPAP**

The breathcare PAP devices take care of patients every night. PAP (Positive Airway Pressure) device works as an air compressor, it constantly blows pressurized air to patient's airway, to prevent airway collapse.

The PAP devices contain CPAP, Auto CPAP and BiPAP.

**CPAP:** Continuous Positive Airway Pressure device

**Auto CPAP:** Automatic Continuous Positive Airway Pressure device

**BiPAP:** Bi level Positive Airway Pressure device

**Improve sleep quality immediately**

No trauma, safe and comfortable

User friendly with little discomfort

**Quiet, noise ≤ 28 dB**

Ultra quiet thanks to 4 methods for reducing noise level.

**Stable 20,000 hours life time.**

**Comfortable** based on years of clinical data it effectively reduces the average treatment pressure and provides a comfortable therapy experience.

**yuwell**

**Connection with oxygen concentrator** to supply oxygen with mask which can help ease symptoms of hypercapnia.

Internal software: GB, IT

Supplied with carrying bag, 2 filters, air hose, heated humidifier, breathing hose mask, SD card (only 53701), power adapter, power cable and manual (GB, IT)

- **53704 AIR SOFT TUBE**
- **53705 BREATHING NOSE MASK**
- **53706 AIR COTTON FILTER - box of 10** Advised replacement every 2-3 months
- **53707 CONNECTOR to oxygen concentrator**



53705

**TECHNICAL SPECIFICATIONS**

Treatment mode:	CPAP, Auto CPAP (53701 only)
Pressure range:	4-20 cm H <sub>2</sub> O
Pressure accuracy:	± 0.5 cm H <sub>2</sub> O
Time-lapse boosting:	0-45 min
Alarm protection:	face mask fell alarm
Operating power:	100-240 V, 50-60 Hz DC 24 V
Automatic altimetric compensation:	3500m
USM air circuit system:	ultra silence air circuit system
PCM:	noise removal technology
3A self adapting frequency adjustment technique	
Size - weight:	27x13.5xh 10 cm - 1.5 kg



Separable body



Medical humidifier for 1 day line



3.5 inches LCD screen



Portable bag

# SINGLE CHANNEL PALM ECG: CARDIO-A AND CARDIO-B

CE 0123



33259

CE 0476



33260

**4 MEASUREMENT MODES:  
PALM, LEG, CHEST,  
TRADITIONAL**

**PALM ECG'S** are designed for general practitioners or for domestic users who suffer from cardiovascular diseases such as hypertension, coronary disorders, giving the possibility of a daily ECG test. Records can be saved and used as a reference for clinical applications. **4 measurement modes: palm, leg, chest or lead wire traditional measurement.**

Main features:

- small, portable and easy to use
  - 30 second ECG waveform and measurement results
  - 600 (CARDIO-A) or 1200 (CARDIO-B) ECG waveform can be saved
  - 5 hours (CARDIO-A) or 10 hours (CARDIO-B) ECG continuous measurement data storage
  - analysis and report of 8 types (CARDIO-A) and 17 types (CARDIO-B) of ECG waveform
  - USB 2.0 interface with option data cable and ECG viewer software
  - traditional measurement with optional ECG cable
- CARDIO B with Bluetooth module for wireless data transmission.** Allows to download data on your smartphone or tablet, compatible with Android.  
Supplied with multilingual manual and box (GB, FR, IT, ES).

GIMA code	PALM ECG
33260	CARDIO-A palm ECG
33261	CARDIO-B palm ECG - colour display
33259	CARDIO-B Bluetooth palm ECG+viewer software
ACCESSORIES	
33265	ECG viewer software+USB 2.0 cable - for 33260, old 33261
33249	ECG viewer software + USB 2.0 cable for new 33261 since SN: XXS02JL01044 - Jan 2014
33248	New ECG 3 pin lead cable - 3 leads - optional - 2012 from SN: XXQ00HJ03925 for 33260 from SN: XXS02HL01709 for 33261
33264	Old ECG banana lead cable - 3 leads - optional

TECHNICAL SPECIFICATIONS		
	CARDIO A	CARDIO B
ECG bandwidth:	0.5 Hz - 40 Hz	1 Hz - 40 Hz
Heart rate measuring range:	30 - 240 bpm ± 2 bpm	
LCD back light display:	128x64 dot matrix	240x160 dot matrix
Display size:	49x25 mm	57.6x40 mm
Power:	2xAAA batteries	
Dimensions	115x58x18 mm	125x70x21.5 mm
Weight	65 g	106 g

# CARDIO-C: 3 CHANNEL POCKET ECG

iHealth  
Bluetooth ECG  
see page 4

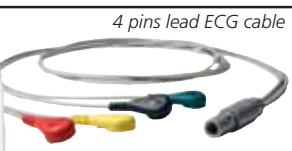

4 pins lead ECG cable

True colour 3.5" TFT display

CE 0123

FDA 510 (K)

Pocket size: 13x9.5x3.2 cm

32 MB memory inside

## • 33245 CARDIO-C POCKET ECG 3 channel

- small size, light-weight and easy to carry
  - one-key measurement
  - clear ECG waveform and interpretation of results on colour dot-matrix TFT 3.5" screen
  - up to 19 types of measurement results
  - high capacity built-in memory: 24 hours records storage and review for single channel waveform and 8 hours record storage and review for 3-channel waveforms
  - quick measurement: **by built-in metal electrodes**, on palm, chest or leg or **by external lead wires** (needs optional limb and chest electrodes)
  - data management to review or delete data records locally or to upload to PC
- Supplied with ECG viewer software, USB cable, power transformer, ECG 4 pins lead wire, 25 disposable electrodes, manual (GB, FR, IT, ES, DE, PT).  
Other accessories see at page 277-278.

- 33364 SET OF 4 LIMB CLAMP ELECTRODES (4 COLOURS) - adult
- 33327 DISPOSABLE TNT ELECTRODES Ø 55 mm

TECHNICAL SPECIFICATIONS	
Heart rate measuring range:	30 bpm ~ 240 bpm
Heart rate measuring accuracy:	± 2 bpm or ±2% whichever is greater
ECG bandwidth:	0.5 Hz ~ 40 Hz
Internal noise level:	≤ 30µVp-p
Display scale:	5.0 mm/mV ±10%
Common-mode rejection ratio (CMRR):	≥ 60 dB
Waveform sweeping speed:	20 mm/s ±10%
Input loop current:	≤ 0.1 µA
Input impedance:	≥ 5 MΩ
<b>Power</b>	
Power:	4 AA alkaline batteries
Supply voltage range:	4.4 ~ 6 VDC
Max average working current:	≤ 160 mA
Auto power-off:	can be adjustable between 1-5 mins
Low battery indication:	4.4 VDC ±0.2 VDC

## Methods of ECG measurements: direct or with lead wires

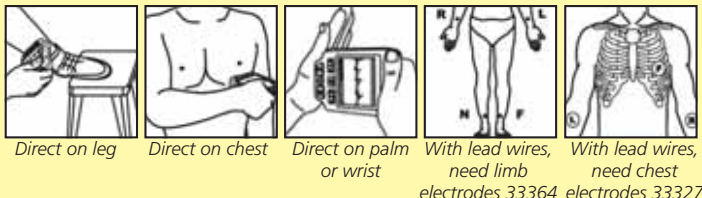

Internal software in GB, IT, FR

## CARDIPOCKET ECG - 3 CHANNELS

### • 33232 CARDIPOCKET ECG 3 CHANNELS - with software

12-lead ECG printing ECG waveform with thermal printing system, measuring and diagnosing ECG waveform parameters automatically.

- **full-automatic analysis function:** auto-analysis and auto diagnosis for routine ECG parameters. It provides measurement results and auto diagnosis conclusion for HR, P-R interval, P Duration, QRS Duration, Q-T interval, Q-tc, P Axis, QRS Axis, T Axis, R(V5), S(V1), R(V5)+ S(V1)

- **2.83" colour LCD screen** (resolution 320x240) that operates both with touch screen and keys

- **high resolution thermal array output system** 8 dots/mm (vertical)

- **built-in rechargeable lithium detachable battery** can continuously work for 4 hours, print up to 90 minutes and 150 ECG

- **store up to 100 cases** in a SD card (not included)

- **high-accurate digital filter** eliminates baseline drift and distortion to ECG waveform

- **ECG-Sync software** to form a ECG workstation

• 32963 THERMAL PAPER - box of 20 rolls

• 33328 ECG CABLE spare

• 33233 RECHARGEABLE Li-Ion BATTERY

#### TECHNICAL SPECIFICATIONS

Power:	AC: 100-240 V, 50/60 Hz - DC 12V rechargeable lithium battery 2,000 mAh	
Noise level:	≤15 μVp-p	CMRR: >60 dB, > 100 dB (add filter)
EMG filter:	25/35 Hz	Time constant: ≥3.2 s
Frequency response:	0.05-150 Hz (-3 dB - 0.4 dB)	
Patient leakage current:	<10 μA	
Recording paper:	50 mm x 20 m, high speed thermal paper	
Paper speed:	6.25, 12.5, 25, 50 mm/s ±5%	
Safety standard:	IEC class I, type CF defibrillation-proof applied part floating and defibrillation protection	
Input mode:		
Input circuit current:	≤0.1 μA	Input impedance: ≥50 M Ω

Size: 207x96x62 mm  
Net weight: 500 g

#### STANDARD ACCESSORIES

- Patient cable
- 1 roll of paper
- 1 rechargeable lithium battery
- 4 limb electrodes
- 6 chest limb electrodes
- 1 user manual (GB, IT, FR)
- 1 CD software (GB, FR, IT, ES, DE, TR) and cable for connection to PC

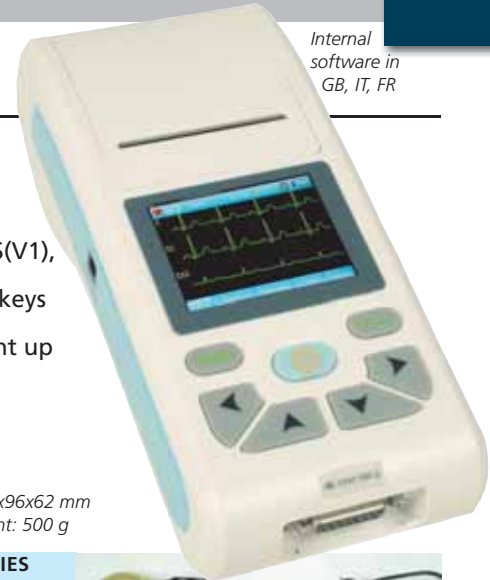

## CARDIPOCKET ECG - 1 CHANNEL

### • 33257 CARDIPOCKET ECG - standard 12 lead ECG - with software

Compact and lightweight pocket device with unbeatable features:

- wide graphic display (it allows "live" view of ECG trace and selection of all parameters)

- rechargeable lithium battery operated (80 ECG with full charge)

- PC software with interpretation included for storing data into PC (GB/IT)

(operating system: Microsoft Windows 2000/XP/2003/Vista/7)

- multilanguage internal software: GB, IT, DE, FR, ES, TR, CN

- real time continuous records of clear and exact single channel ECG waveform and notes. The notes include mark, sensitivity, chart speed, filter mode, etc

- full-touch keyboard control, easy to use. Screen displays, working position, state of the instrument are clear and easy to be read.

• 32963 THERMAL PAPER - box of 20 rolls

• 33328 ECG CABLE - spare

• 33243 RECHARGEABLE Li-Ion BATTERY up to S.N. CD 1212100050

• 33244 RECHARGEABLE Li-Ion BATTERY since S.N. CD 130730000-1

#### TECHNICAL SPECIFICATIONS

Power:	AC: 100-240V, 50/60 Hz - DC: 7.4V / 2,000 mAh	
	DC: 9V rechargeable battery	
In optimal DC state up to 8 h standby time, up to 4 h continuous print		
Noise level:	≤15μVp-p	CMRR: >60 dB, >100 dB (add filter)
EMG filter:	35 Hz (-3 dB)	Time constant: ≥3.2s
Sensitivity display:	standard sensitivity: 10mm/mV±2%	
Sensitivity setting:	1/2, 1, 2 (cm/mV), conversion deviation ≤5%	
Recording system:	thermal-array, 8 dots/mm (vertical), 16 dots/mm (horizontal, 50 mm/sec), 32 dots/mm (horizontal, 25 mm/sec)	
Paper speed:	25 mm/s, 50 mm/s ±5%	
Recording paper:	50 mm x 20 m, high-speed roll	
Safety standard:	IEC class I, type CF	
Input circuit current:	≤50nA	

Integrated thermal printer



Weight 800 g with rechargeable battery

Compact: only 190 mm (size: 190x90x40 mm)

60x35 mm wide display

#### STANDARD ACCESSORIES

- Patient cable
- 1 roll of paper
- 1 rechargeable lithium battery
- 4 limb electrodes
- 6 chest limb electrodes
- 1 user manual (GB, IT, FR)
- 1 CD software and cable for connection to PC



## PM10 PALM ECG WITH SOFTWARE AND BLUETOOTH

### • 33246 PM10 PALM ECG - with software and Bluetooth

PM10 is a homecare device to check ECG parameters. It can be used as a reference for patient to take further medical treatment and reference for doctor to diagnose. It can help to early prevent from cardiovascular diseases and reduce risks. Intelligent design, it achieves remote health management through mobile application; it can automatically start measurement, store ECG, upload data, download health results. Suitable for patients with chronic diseases, especially coronary heart disease, diabetes, hypertension, myocarditis, obesity, chest pain, palpitations and dyspnea.

#### 4 MEASUREMENT MODES



Limb leads I

Chest leads V

Limb leads II

Limb leads III

#### Features:

- 1.77" colour TFT-LCD
- quick ECG test with a simple touch. User friendly
- accurate conclusion can be obtained immediately after measuring
- continuously record for up to 500 cases with built-in rechargeable lithium battery in full charge
- Bluetooth transmission
- ECG data can be saved to cloud Platform permanently, easy to check and analyze
- historical data can be printed at any time, easy to diagnose

Size: 100x45x15 mm  
Weight: about 60g

Supplied with a carrying bag, a multilanguage manual (GB, FR, IT, ES, DE, PT) and a CD software to visualize data on PC



33246

# DIGITAL SINGLE, 3 OR 3/6 CHANNEL ECG

- **33220 SINGLE CHANNEL ECG 100G**
  - large LCD display waveform and data
  - high-resolution thermal printing array system
  - frequency response is as high as 150 Hz
  - capable of printing continuously on channel trace and annotations including lead mark and parameter such as sensitivity, paper speed and filter operation status
  - high resolution digital filter inhibits baseline drift without affecting ECG waveform
  - floating input circuit meets IEC safety standard
  - rechargeable battery supporting more than 50 patient examinations
  - internal software: GB, IT, DE, TR, RU, CN
  - manual: GB, IT, ES
- **33225 RECHARGEABLE BATTERY - spare**
- **32968 PAPER ROLL 50 mm x 20 m - box of 20**
- **33328 ECG CABLE - 10 leads - spare**



**CONTEC™**

33220

USB connection allows real-time transmission to PC, remote data analysis and diagnosis, management and printing through the PC



33221

- **33221 3 CHANNEL ECG 300G - monitor up to 12 channels**
  - 3.5" TFT colour LCD screen
  - 12 leads simultaneous display
  - thermal printing system
  - AC and DC power supply
  - high capacity built-in lithium rechargeable battery
  - battery power supports up to 150 ECG continuous records
  - built-in Database
  - built-in memory can store more than 1000 cases
  - digital signal processor for filter
  - auto-measurement, auto-analysis, auto-interpretations
  - ECG-Sync software, USB connection to PC
  - internal software: GB, FR, IT, ES, DE, TR, PL, PT, SI, YU, RU, KZ, CN
  - PC software: GB
  - manual: GB, IT, ES, FR
- **33226 RECHARGEABLE BATTERY - spare**
- **32969 PAPER ROLL 80 mm x 20 m - box of 10**
- **33328 ECG CABLE - 10 leads - spare**

USB connection allows real-time transmission to PC, remote data analysis and diagnosis, management and printing through the PC

- **33222 6 CHANNEL ECG 600G - monitor up to 12 channels**
  - 7" TFT, colour LCD touch screen
  - 12 leads simultaneous display
  - digital isolation technology and signal processing solution, digital filter
  - patient management, name, age and id, detail analysis report
  - built-in lithium rechargeable battery
  - thermal printing system provides more than 10 printing modes
  - can print 90 minutes and print out 150 ECG continually
  - ECG-Sync software, USB connection to PC and built-in memory can store more than 1000 cases
  - auto-measurement, auto-analysis and auto-interpretation
  - internal software: GB, FR, IT, ES, DE, TR, PL, PT, SI, RU, KZ, CN
  - PC software: GB. Manual: GB, IT, FR
- **33226 RECHARGEABLE BATTERY - spare**
- **32970 PAPER ROLL 110 mm x 20 m - box of 10**
- **33328 ECG CABLE - 10 leads - spare**



33222

**TECHNICAL SPECIFICATIONS**

		ECG 100G	ECG 300G	ECG 600G	
ECG instrument Input	Safety Type	Class I, type CF applied part, which has defibrillation-proof applied part			
	Lead	Standard 12 leads			
	Input way	Floating and defibrillation protection			
	Patient leak current	<10µA			
	Sampling rate	800 Hz	1,000 Hz	1,000 Hz	
	A/D conversion	12bit			
Dispose Wave Data	Frequency response	0.05Hz~150Hz (-3dB, + 0.4dB)			
	Time constant	≥ 3.2s			
	CMRR	>60dB, >100dB(Add filter)			
	Enduring polarization voltage	±500mV			
Waveform output	Noise level	<15µVp-p			
	EMG interference filter	35Hz (-3dB)	25Hz/35Hz (-3dB)		
	AC filter	50Hz/60Hz (-20dB)			
	Recording way	Thermal printing system	Thermal printing system (32spots/mm)		
Power supply Fuse	Recording paper	50mm(W)×20m(L)	80mm(W)×20m(L)	110mm(W)×20m(L)	
	Sensitivity	5, 10, 20mm/mV	2.5, 5, 10, 20, 40 mm/mV		
	Paper speed	Auto-record: auto leads changing		Auto-record: 25mm/s, 50mm/s	
		Manual-record: 25 mm/s, 50 mm/s		Rhythm record: 25 mm/s, 50 mm/s Manual-record: 5, 6.25, 10, 12.5, 25, 50 (only 33221), 100 mm/s (only 33222)	
Form	AC	110-220V, 50/60 Hz			
	DC - Lithium battery	7.4V, 2000 mAh	7.4V, 3500 mAh		
Form	Size	2 pcs φ5×20mm AC time lag; T250mA/250V(Power Supply:220V)			
	Net Weight	1.5 kg	1.6 kg	1.7 kg	



**STANDARD ACCESSORIES**

- ECG cable - 1 set
- Limb electrode clamp - 1 set
- chest electrodes - 1 set
- Ground wire
- Power connection
- Paper roll
- USB connection and PC software (only 33221 and 33222)

- **33228 CARRYING BAG 39x29x14 cm**



## 3 AND 6-12 CHANNEL DIGITAL ECG WITH HIGH RESOLUTION MONITOR

33334

33350

WITH INTERPRETATION



3 YEARS WARRANTY made in Italy

Portable with small dimensions and light weight

Large, high resolution backlight Display: LCD 320x240 dots.

- 33334 CARDIOGIMA 3M - 1-3 ch. with interpretation
- 33350 CARDIOGIMA 6M - 3-6-12 ch. with interpretation (monitor 3-6 channels, printer 3-6-12 channels)
- LCD monitor in Standard or Cabrera format with base line setting
- High resolution thermal printer (8 dots/mm): hardcopy 1-3 or 3-6-12 channels real time with possibility to print a millimetric grid
- Manual or automatic recording
- Image freeze with memory scrolling for reviewing and hard copy of acquired signals (Memory 10 seconds for each lead)
- Digital filters for elimination of muscle tremors, power line and base line noises
- Pacemaker detection
- Power supply by built-in high capacity Ni-Cd batteries and fast charging time

- Very simple operation by pre-defined fast keys and menus
  - Based on a risk processor for a full digital signal processing
- Made in Italy.

### STANDARD ACCESSORIES 3M AND 6M

Patient cable	6 chest limb electrodes
4 limb electrodes	1 roll of paper
Manual (English, Italian)	1 bottle of gel
Rapid guide: English, Spanish, Italian	Battery

GIMA code	CARDIOGIMA ACCESSORIES	Minimum order
27139	Transport bag (see at page 60)	-
32996	Thermal paper 58 mm x 25 m (Cardiogima 3M)	box of 20
32953	Thermal paper 112mm x 23m (Cardiogima 6M)	box of 10
33328	ECG cable 10 leads - spare	-

### TECHNICAL SPECIFICATIONS CARDIOGIMA 3M AND 6M

Power supply: internal rechargeable Ni-Cd batteries  
 AC/DC Adapter: 100-240V, 50-60 Hz; 200mA  
 Battery autonomy: 2.5 hours  
 Applied part: CF type  
 Input impedance: > 100 Mohm  
 Frequency response: 0.05: 145 Hz  
 Cmrr: > 91 dB (33334), Cmrr: > 100 dB (33350) Time constant: > 3.2 s  
 Acquisition: 12 bit 800 samples/sec/channel-isochrome  
 Leads: 12 standard or Cabrera

Sensitivity: 5mm/mV; 10mm/mV; 20mm/mV ±5%  
 Scrolling speed: 5mm/s; 10mm/s; 25mm/s; 50mm/s  
 Signal memory: 10s for each lead  
 Printer: thermal printer 8 dots/mm, paper 58 mm (3M) 110 mm (6M).  
 Filters: muscles tremors 35Hz digital; power line interferences 50-60Hz digital; high pass 0.5Hz digital  
 Defibrillation protection: internal  
 Display/Hardcopy: 1/3 channel (3M) 3/6/12 channel (6M)  
 Dimensions: 240x160x65 mm. Weight: 1.5 kg. Made in Italy

## CARDIOGIMA 1M - 1/3 CHANNEL ECG WITH PARAMETERS CALCULATION



3 YEARS WARRANTY made in Italy

33329

- 33329 CARDIOGIMA 1M - 1-3 channel ECG with monitor
- A real portable ECG with small dimension and light weight (1 kg), with LCD monitor 128x64 pixel, high resolution thermal printer (8 dots/mm hardcopy, 1 channel real time) and parameters calculation. With manual or automatic recording, memory 10 seconds for each lead. Includes digital filters for elimination of muscles tremors, power line and base line noises. Based on a risk processor for a fully digital signal processing. Made in Italy.
- 32996 THERMAL PAPER 58 mm x 25 m - box of 20
- 33328 ECG CABLE 10 leads - spare

### STANDARD ACCESSORIES

Patient cable	1 roll of paper
1 bottle of gel	4 limb electrodes
Manual (English, Italian)	6 chest limb electrodes
Rapid guide: English, French, Spanish, Italian	Battery

### TECHNICAL SPECIFICATIONS

Power supply: internal rechargeable Ni-Mh batteries  
 AC/DC Adapter: 100-240V, 50-60 Hz; 200mA  
 Battery autonomy: 3 hours  
 Applied part: CF type  
 Input impedance: > 100 Mohm  
 Frequency response: 0.05: 145 Hz  
 Cmrr: > 100 dB time constant: > 3.2 s

Acquisition: 12 bit 800 samples/sec/channel  
 Leads: 12 standard or Cabrera  
 Sensitivity: 5mm/mV; 10mm/mV; 20mm/mV ±5%  
 Scrolling speed: 5mm/s; 10mm/s; 25mm/s; 50mm/s  
 Signal memory: 10 sec for each lead  
 Printer: thermal printer 8 dots/mm, paper 58 mm.  
 Defibrillation protection: internal

Filters: muscles tremors 35Hz digital; power line interferences 50-60Hz digital; high pass 0.5Hz digital  
 Dimensions: 190x120x60 mm. Weight: 1 kg.  
 Conformity standards: 93/42/CEE; EN60601-1; EN60601-1-2; IEC601-2-25 Made in Italy

# EDAN SINGLE OR THREE CHANNEL ECG

33330



33333

Single and three channel with 12 channel display



INTERPRETATION

COLOUR DISPLAY



## EDAN PORTABLE ECG - 1 and 3 channel

- foldable LCD screen, vivid waveform display
- built-in high resolution thermal printer
- built-in rechargeable Li-ion battery, AC/DC supply
- complete digital filter, avoid baseline drift, AC, EMG interfere
- automatic baseline adjustment
- auto/manual operation selectable
- lead-off detection and alarm

## SE-3 Three channel colour ECG also features

- interpretation tested by CSE/AHA/MIT database
- 12 Lead simultaneous acquisition
- automatic ECG parameters measurement and analysis
- auto, manual, rhythm off work mode
- support barcode scanner to simplify patient information input
- LAN/RS232/USB connection to PC
- 12 leads grid printing on normal A4 paper by external printer

## ECG Viewer Software: PC based ECG data management software

- compatible with Windows XP, WIN 7, Vista (32 bit, 64 bit)
- multi format reports - XML/SCP/DICOM/PDF/JPG/BMP/TIFF/PNG
- support bi-directional communication with ECG device

GIMA code	EDAN ECG AND ACCESSORIES
33330	Edan SE-1 Single Channel ECG
33333	Edan SE-3 colour Three Channel ECG - interpretative
33336	ECG-Viewer Software (GB, FR, IT, DE, PL, RU, ES, TU) for 33333
32963	Thermal paper - roll 50mm x 25m for 33330 and 33305
32964	Thermal paper - roll 80mm x 25m for 33332/3 and 33306
33328	ECG cable - spare
33318	Rechargeable Lithium battery 2500 mAh - spare
27139	Transport bag - see page 60

## TECHNICAL SPECIFICATIONS

	33330	33333
Lead:	One lead	Standard 12 leads
Acquisition mode:	One lead	12 leads simultaneously
Sensitivity:	2.5, 5, 10, 20 mm/mV	> 50 MΩ (10 Hz)
Input impedance:	> 50 MΩ (10 Hz)	EMG Filter 25/35/45 Hz off
Filter:	EMG Filter 35 Hz (-3 dB)	AC/DFT Filter 50 Hz/60Hz (-20 dB)
		DFT Filter 0.05/0.15/0.25/0.32/0.5/0.67 Hz
		Low pass filter 150/100/75 Hz
		AC Filter on/off
Recording mode:	Auto/Manual	Auto/Manual/Rhythm/USBPRT
Rhythm lead:		Any lead selectable
Safety standard:		IEC I/CF
Power supply:	AC: 100-115 V, 220-240 V, 50/60 Hz	Rechargeable Li-ion battery: voltage 14.8 V
		More than 6.5 hours continuous operation with battery supply
Data storage:	-	500 ECG's
Thermal paper:	50 mm x 30 m	rolled 80 mm x 20 m
		folded 80x70 mm x 200 pages
Paper speed:	25 mm/s, 50 mm/s (± 3%)	5mm/s, 6.25 mms 10 mm/s, 12.5 mm/s, 25 mm/s, 50 mm/s (± 3 %)
Dimension:		300x260x75 mm
Weight:	2.3 kg (with battery)	2.5 kg (without battery)
Display:	192x64 pixel LCD	320x240 pixels LCD (colour screen)
Selectable display language	GB, IT, FR, ES, PL, RU, TR, UA	GB, IT, FR, ES, RU, PL, CZ, RO, DE, TR, HR, UA
Interface:	RS 232	Ethernet, RS232, USB
Barcode scanner support:	-	yes
Report formats:	-	PDF, Dicom, SCP, XML

## STANDARD ACCESSORIES

Patient cable	1 roll of paper	4 limb electrodes
1 bottle of gel	Rechargeable battery	6 chest limb electrodes
Manual: GB, IT. On request: FR, ES, PT, TR (SE-1 and SE-3), DE, RU (SE-3 only)		

# MINDRAY BENEHEART R3 ELECTROCARDIOGRAPH

## • 33301 MINDRAY BENEHEART R3 ELECTROCARDIOGRAPH 3 channels

Lightweight portable cardiograph for resting ECG diagnosis.

### Reliable analysis - Glasgow algorithm

Utilizes the University of Glasgow ECG analysis algorithm, one of the world-leading resting ECG interpretations.

### Great Portability - only 1.2 kg

Weighs only 1.2 kg with battery, easy to carry.

### 5" clear colour display

Offers the highest resolution in industry, enabling clinicians to observe real-time waveforms accurately.

### Convenient operations

ECG recording is automatically unfolded on the writing pad at the top of the unit for notes or signature.

### Unique recorder - Z-folded or rolling paper

Compatible with both rolling paper and Z-fold paper.

Easily switchable without dismantling the pressure lever.

### • 33014 ROLL THERMAL PAPER - 80 mm x 20 m - box of 10

### • 33016 Z-FOLD THERMAL PAPER - 80x70 mm x 200 sheet - box of 25

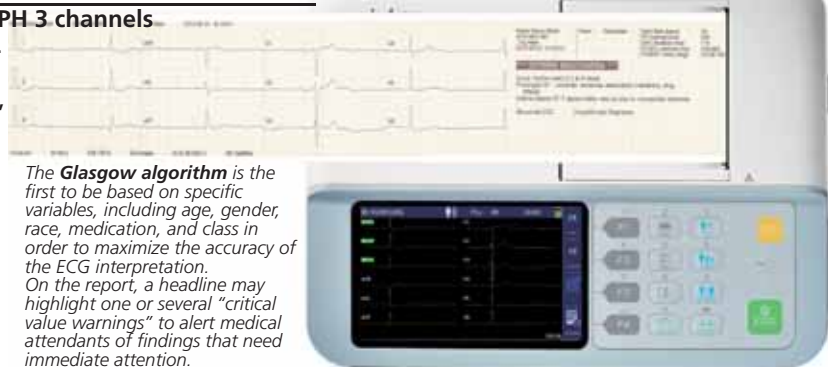

The **Glasgow algorithm** is the first to be based on specific variables, including age, gender, race, medication, and class in order to maximize the accuracy of the ECG interpretation. On the report, a headline may highlight one or several "critical value warnings" to alert medical attendants of findings that need immediate attention.

## STANDARD ACCESSORIES

Cable with banana plugs, IEC	1 roll paper
Limb clamp set of 4	Rechargeable battery
Chest bulb set of 6	User manual in: GB, FR, DE, HU, IT, PL, ES, TR
Glasgow algorithm (available in 13 languages as internal software)	

## TECHNICAL SPECIFICATIONS

Power	AC power: 100 to 240 VAC ± 10% 60 VA	ECG amplifier: DC-coupled	Thermal printer:	Dot array/Width 80 mm/speed 5, 12.5, 25, 50 mm/s
Battery-type:	rechargeable Lithium ion battery 11.1 V typical, 2,500 mAh	Input impedance: 50 MD at 10 Hz, defib protected	Software	
- capacity:	6 hours of continuous operation without recording or 500 ECGs in 2.5 x 4 format at 25 mm/s and 10 mm/mV	Patient leakage: < 10 µA	Resting ECG mode:	Records and prints 12-lead resting ECG with 10-second duration
- charge time:	3.5 hours with power off	Heart rate meter: 30 to 300 BPM ± 10% or ± 5 BPM, whichever is greater	Patient information:	Patient ID, secondary ID, age, date of birth, gender, race, medication class and V3 electrode placement
Processing		Sensitivity/gain: 5, 10, 20 mm/mV, Auto	Internal storage:	800 ECGs in internal memory
ECG analysis	500 samples/second (sps)	Colour display	ECG Storage format:	PDF and Mindray storage format
Digital	1,000 samples/second/channel	Resolution: 800x400	internal software:	GB, FR, IT, ES, DE, PL, PT, TR, RU, HU, RO, CZ, CN
Pacer detection	16,000 samples/second/channel	Display data:	Report formats	Thermal printer/PDF/A4/letter
Acquisition mode:	Pre-acquisition or post-acquisition provide 10 seconds of instantaneous ECG acquisition		Size/Weight:	250x194xh 56 mm/1.2 kg including battery

# MULTI CHANNEL ECG WITH INTERPRETATION ON PAPER



33354

• **33354 CARDIOGIMA 12 ECG - 3-6-12 channel**  
 Cost effective 12 channel resting ECG recorder without performance compromise. The simultaneous record of 12 channels has a high diagnostic value - all the 12 channels are shown at the same time. A4 size paper, one body type.  
**Main Features:**

- 12 leads simultaneous 10-second resting ECG with interpretation in only 60 seconds multilanguage.
- Internal software+print in GB, FR, IT, DE, RU, TR, CN.
- wide paper printing (A4 size thermal paper, fax paper is OK)
- combined output of all relevant curves, patient data, date, time and instrument settings

**- PC Connections**

Connection to PC with RS 232 port or LAN to submit recorded ECG signal to other specialist for evaluation (only a modem is needed)

**- ECG filing system**

A fully configured PC-based software enables to record, print, change the settings of ECG's and save them in JPG format, which ensure compatibility with most EMR package.

- **rechargeable batteries (optional)** with 1 hour capacity in normal use (about 100 ECG printouts)

**TECHNICAL SPECIFICATIONS**

ECG Leads:	3-6-12 channel illustration of ECG signals in continuous recording or 10 sec. recording with interpretation.
Dimension:	296x305.5x92.5 mm    Approx 3 kg
Recording channel:	3, 6, 12 channel and 1 channel (60 sec.)
Sensitivity:	2.5, 5, 10, 20, auto (I-aVF: 10, W1-V6: 5) mm/mV
Printing speed:	12.5; 25; 50 mm/s
Filters:	AC (50/60 Hz, -20 dB or better), Muscle (25-35 Hz, -3 dB or better) Low pass filter (off, 40 Hz, 100 Hz, 150 Hz)
Display:	2x16 character LCD display
LCD display:	Sensitivity, speed filter status, HR, Printing form, rhythm lead
LED indicator:	Signal quality, power source, battery
Keyboard:	Membrane keyboard, alphanumeric and symbol available
Patient data:	ID, name, age, sex, height, weight
Basic measurement:	Heart rate, PR, QRS, QT/QTc, P-R-T axis
Recorder:	Thermal print head, thermal paper roll Report papers: A4: 215X297 mm (8.5"x11.7") Letter: 215x280 mm (8.5"x11")
Resolution:	vertical: 8 dots/mm, horizontal: 16 dots/mm
Electrical:	Internal noise: 20 µV (p-p) max Input circuit: floating input Isolated and defibrillation protected DC offset voltage: ≥ ± 300 mV Patient leakage current: < 10µA Frequency response 0.05-150 Hz
Power:	Power supply: AC or built-in battery (options) Power requirement: 100-240 Vac, 50/60 Hz, 1.0-0.5 A Power consumption: 60 W max
Battery capacity:	1 hour of normal use (approx. 100 automatic ECG printouts)
Communication:	PC Connection with RS-232 interface and lan
Safety:	Class I, Type BF
Conformity:	CE, FDA, KFDA, CFDA, NCC

Made in Korea

**STANDARD ACCESSORIES**

- |                                       |                            |
|---------------------------------------|----------------------------|
| 1 PC software (GB/IT)                 | 1 ECG gel tube (250 ml)    |
| 1 LAN cable                           | 1 Recording paper roll     |
| 1 Patient cable - 10 leads            | 1 Operation manual (GB/IT) |
| 4 ECG clip-on electrodes              |                            |
| 6 Chest electrodes, suction for adult |                            |
| 1 Power cable                         |                            |

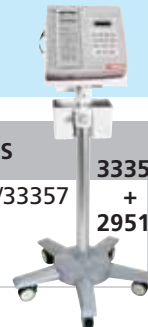

GIMA code	CARDIOGIMA 12 ACCESSORIES	
29534	Rechargeable battery - for 33354/33355/33357	33354 + 29519
32950	Thermal paper A4 - for 33354-5-7 - box of 5	
33328	ECG cable for 33354-5-7	
29519	Trolley for 33354-5-7	

# DIGITAL 12 CHANNEL COLOUR ECG WITH WI-FI



33223

- **33223 12 CHANNEL ECG 1200G with WI-FI**
- 8" TFT display, 800x600 dots high resolution colour LED backlight
- simultaneous 12 leads acquisition and display
- digital signal technique, AC filter, baseline filter, EMG filter
- auto-analysis and auto-interpretation
- Multi-mode display and printing, such as 12, 6+1 (rhythm), 6, rhythm 12, rhythm 10, rhythm 8, rhythm 6. Manual, Freeze etc
- 0.5 built-in lithium rechargeable battery
- 2 USB and LAN Socket for uploading data to PC
- built-in flash memory. Stores more than 1,000 files
- Multi-language internal software: GB, FR, IT, ES, PT, PL, SI, TR, RU, KZ, CN.

- **33227 RECHARGEABLE BATTERY - spare**
- **32967 PAPER ROLL 210 mm x 30 m**
- **33328 ECG CABLE - 10 leads - spare**



**TECHNICAL SPECIFICATIONS**

Input way	Floating and defibrillation protection
Lead	Standard 12 leads
Patient leak current	< 10 µA
Input impedance	≥ 50 MΩ
Frequency response	0.05 - 150 Hz (-3 - + 0.4 dB)
Time constant	≥ 3.2 s
CMRR	>60 dB, > 100 dB (adding filter)
EMG interference filter	25/35 Hz (-3 dB)
Thermal paper	210 mm x 30 m high-speed
Paper speed	Auto and rhythm record: 25, 50 mm/s, ±5% Manual record: 5, 6.25, 10, 12.5, 25, 50 mm/s, ±5%
Sensitivity selections	2.5, 5, 10, 20, 40 mm/mV, ±5%. Standard sensitivity is 10 mm/mV ±0.2 mm/mV.
Auto record	Record setup according to auto record format and mode, automatically changing leads, measuring and analyzing.
Rhythm record	Record setup according to rhythm record format and mode, automatically measuring and analyzing.
Manual record	Record setup according to manual record format, manually changing leads.
Measurement parameters	HR, P-R interval, P Duration, QRS Duration, T Duration, Q-T interval, Q-Tc, P Axis, QRS Axis, T Axis, R(V5), S(V1), R(V5)+S(V1)
Product safety type	Class I CF defibrillation and pacing protection
Size	334x320x85 mm
Power	AC: 100-240 V, 50/60 Hz DC: 14.8 V, 3700mAh rechargeable lithium battery

**STANDARD ACCESSORIES**

- |  |                  |
|--|------------------|
| 1 ECG cable                                    | 1 ground wire    |
| 1 set limb electrode clamp                     | 1 paper roll     |
| 1 set chest electrodes                         | Power connection |
| USB connection                                 |                  |
| Rechargeable battery                           |                  |
| Software (same languages as internal software) |                  |
| Manual: GB, FR, IT                             |                  |



# CARDIO 7: 12 CHANNEL RESTING ECG WITH TOUCH SCREEN

**SOFTWARE EKG VIEW PLUS**  
for data storage on PC



Long term ECG recording and automatic arrhythmia detection

Touch screen operation full alphanumeric keyboard support

Optional spirometer function

USB function

- **33357 ECG CARDIO 7: 12 CHANNEL ECG WITH TOUCH SCREEN**
- 12 channel interpretive ECG for adult, pediatric and neonatal use
- over 130 kinds of interpretation results based on advanced Minnesota code, HRV (Heart Rate Variability analysis)
- memory for up to 200 patients
- real-time preview monitor
- PC compatible through LAN or Wi-Fi
- multi-language selectable software (GB, RU, FR, DE, IT, CN, ES, TU, PL, RU, PT)
- lead fault message
- pace maker detection
- automatic arrhythmia detection
- 3, 5, 10 minutes long term recording
- grid function allows you to use low cost plain fax paper
- wide and clear colour 7" TFT LCD (800x480)
- touch screen for easy operation
- full disclosure function
- **32950 THERMAL PAPER A4 - box of 5 rolls**
- **29534 RECHARGEABLE Ni-MH 12 V BATTERY up to S.N. T7xxxxxxx - optional**
- **29536 RECHARGEABLE Li-Ion BATTERY since S.N. T8xxxxxxx - optional**
- **29519 TROLLEY**
- **33328 ECG CABLE**



**33357**

One touch operation for analyzing, storing and printing within 3 seconds

Rotary key access to all menus

Various standard formats: JPG, PDF, XML, MFER, DICOM

STANDARD ACCESSORIES	
Patient cable - 10 leads	1 paper roll
LAN cable	4 limb electrodes
1 bottle of ECG cream (70 g)	6 chest limb electrodes
1 power cable	EKG View Plus (GB, IT)
manual (GB, IT)	

### TECHNICAL SPECIFICATIONS

ECG leads :	10 lead, 12 channel simultaneous ECG and acquisition	Resolution:	Vertical: 8 dot/mm
Dimension:	300(W) x 299(H) x 123(D)mm, approx. 3.5 kg		Horizontal: 16 dot/mm
Recording channel:	3 channels + 1 rhythm, 3 channels + 3 rhythm, 6 channels + 1 rhythm, 12 channels, 60 seconds	Electrical:	Internal noise: 20 µV (p-p) max
	1 channel, 3, 5, 10 minutes 1 channel and beat report		Input circuit: floating input
Sensitivity:	2.5, 5, 10, 20, auto (I~aVF: 10, V1~V6: 5) mm/mV		Input impedance: ≥50 MΩ
Printing speed:	5, 12.5, 25, 50, 100 mm/s		Input voltage range: ≥ ±5 mV
Sampling rate:	2,000 samples/sec		Common mode rejection: > 105 dB
Filters:	AC (50/60 Hz, -20 dB or better)		DC offset voltage: ≥ ±400 mV
	Muscle (25~35 Hz, -3dB or better)		Time constant: 3.2 sec
	Base line drift (0.05, 0.1, 0.2 Hz, -3dB or better)	Signal quality control:	Patient leakage current: < 10 µA
Display:	Low pass filter: off, 40 Hz, 100 Hz, 150 Hz		Frequency response: 0.05 ~150 Hz
	7" color TFT LCD display (800x480), 12 channels preview ECG wave		Isolated and defibrillation protected
Monitor display:	ID, date, sensitivity, speed, filter, form, rhythm lead	ECG data storage:	Disconnected lead detection
User interface:	Touch screen (alphanumeric and symbol available), Keyboard, rotary push-knob (pop-up menu)	Power:	Pacemaker pulse detection
Patient data:	ID, name, age, sex, height, weight, smoke, race	Battery (Li-Ion):	storage for 200 ECGs (Internal on flash memory)
Basic measurement:	Heart rate, PR int, QRS dur, QT/QTc, P-R-T axis	Communication:	AC 100~240 VAC, 50/60 Hz or battery (option)
Recorder:	Thermal print head, roll paper	Safety conformity:	2.0~1.0 A, 60 VA max
	A4 report paper: 210x300 mm (8.5"x11")		4 hours of normal use (approx.200 ECG printouts)
			PC connection with LAN D2 Wi-Fi
			Class I, Type CF, CE, CSA, FDA, KFDA, CFDA, CCC

## SPIROMETER MODULE FOR CARDIO 7

• **33356 SPIROMETER MODULE - for code 33357**

It transforms CARDIOGIMA 7 in a 2 in 1 system: ECG-SPIROMETER.

Spirometry measuring values:

**FVC:** FEV 1.0, FEV 1/FVC, FEV 0.2-1.2L, FIVC, FEV 25-75, FEV 75-85%,  
**PEF,** FEF 200-1200 ml, FEF 25%, FEF 50%, FEF 75%, PIF,  
**FET** 100%, FIVC.

**SVC:** SVC, ERV, IRV, TV, EC, IC,

**33356**

**MVV:** TV, MVV, FB

Pre and post bronchodilator comparison.

Presentation: flow volume loop, flow time plot, measurement values table. Complies with ATS standard.

• **33362 DISPOSABLE MOUTHPIECES - box of 100 pcs.**



## ECG CABLE COMPATIBLE WITH MOST ECG BRANDS

• **33328 ECG cable - 10 leads**

Long lasting, individually tested cable compatible with the following ECG machines:

**BIONET:** Cardiocare, Cardiotouch

**CARDIOLINE:** E1, E1R, E3, Delta 300, Delta 360, C3.

**CARDIETTE (Elettronica Trentina):**

Autoruler 12/1, Autoruler 12/3, Excel 103, Excel 106, Astron Comp 1, Astron Comp 3, Astron Comp 6, Start 100 P, Start 100 H, Start 200, Start 200HV, AR600, AR 600 ADV, AR1200, AR1200ADV.

**CARDIORAPID CAMINA:** K111, K112, K33, K36, K300 M, K300 P, K600 P, K600 D, K130 B, K 130 D.

**CONTEC:** 100G, 300G, 600G, 1,200G

**EDAN:** Smart SE-1, SE-3

**ESAOTE:** P80, P8000

**GIMA:** CARDIOGIMA 1M, 3M, 6M, 12, 12M

**HP:** Pagewriter 1513, 154B/C, 1514D, 1515A/B, 1517A.

**KONTRON EKG P80**

**MACQUAIRE CT100, CT200.**

**M4 MEDICAL:** M traces

**NIHON - KOHDEN** Cardiofax 651, 6581, 8110.

**PROGETTI all models:** EPG junior, EPG view, EPG6 view, EPG6 view plus

**SCHILLER AT/1, AT/2, AT/3, AT/4, AT/5, AT/6,**

**AT/10, CS6, CS12, CS100, CV6, P80.**



## HOLTER ECG SYSTEM - 24 HOURS MONITORING



Monitor not included

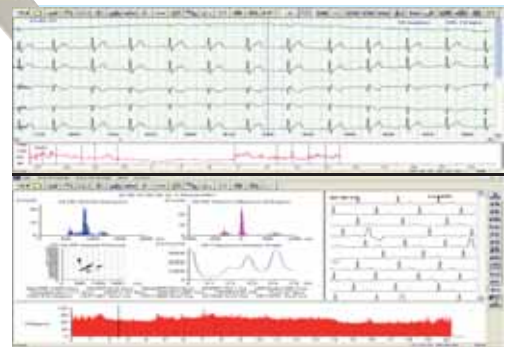

### • 35130 ECG HOLTER + SOFTWARE

ECG Holter system includes ECG recorder and software connectable to a computer system or laser printer. The recorder has built-in flash storage media to increase memory capacity. The sampling rate of 1,000 sampling/sec has improved the quality of waveform.

Accuracy of the system is ensured by AHA and MIT data.

#### Features:

- windows software interface (GB, IT, PL)
  - quick and accurate analyzing system
  - special editing system of R point
  - perfect analysis function of ST segment
  - analysis function of T wave of all channels and T wave trend graph
  - review of ECG trend graph
  - analysis system of HR variability, providing regular SDNN, SDANN, RMSSD, LF, HF, time domain and frequency domain
  - QT analysis and QT trend graph
  - acquire pacing ECG directly without separate channel;
- Also have the functions of VCG, VLP, TVCG, HRT, TWA

#### Recorder:

- 12 channel Synchronized ECG Acquisition
- small ECG recorder with OLED colour screen to display real time ECG waveform and review storage data.
- capacity up to 2G
- selectable sampling rate, 200, 500, 1,000 sampling/sec
- sampling accuracy: 12 bit
- built-in FLASH storage media, to prevent the flash card from damage due to repeated insertion and pull out
- USB interface
- operating system: Win 98, 2000, XP, 7, 8, 10

### • 35131 ECG CABLE - spare

#### TECHNICAL SPECIFICATIONS

Scale voltage: 1mV±5%  
 Standard sensitivity: 10mm/mV ±5%  
 Noise level: ≤30µV  
 CMRR: ≥60dB  
 Frequency response: 10Hz as benchmark, 0.5Hz~55Hz; -3dB  
 Time constant: >3.2s  
 Scan speed: 25mm/s ±5%  
 Enduring polarization voltage: ±300mV

Least measure signal: 50µV p-p  
 Interference between channels: scan track deflection (result from interference between channels) <0.5mm  
 Product safety type: type B (internally powered)  
 Size: 111 (L) x60 (W) x25 (H) mm  
 Net weight: 105 g (without battery)



#### STANDARD ACCESSORIES

- 1 Holter recorder
- 1 CD with software
- 10 leads patient cable
- 10 disposable ECG sensor
- 1 pouch for hanging recorder
- 1 USB cable for data downloads
- Instruction Manual (GB, IT)



## PC-ECG WITH INTERPRETATION SOFTWARE AND USB PORT

### • 33320 PC-ECG + ECG LAB SOFTWARE

Innovative PC-ECG device that can be connected to your PC via USB port. No power cable is required as it is powered through the USB PC cable. The unit is supplied with a 10 banana plug ECG cable (length 295 cm) and a powerful interpretation software (GB, FR, IT, DE, ES, PT, CN).

Main software features:

- 12 lead resting ECG with auto interpretation (ECG)
- vector ECG (VCG)
- sampling screen colour customization
- standard or thermal paper print, B&W or colour
- auto interpretation On or Off
- tests comparison
- multi hour ECG monitoring with holter analysis
- simple exercise stress test with report
- e-mail, PDF, ASCII, HL7, Dicom, GDT Interfaces
- multi ECG report formats
- measurement table
- 90s resting ECG full disclosure

### • 33328 ECG CABLE - SPARE

### • 33321 PC-ECG+CARDIOLOGY SOFTWARE

Same as code 33320 but with the following specialist functions:

- timed vector ECG (TVCG)
- SAECG (Signal Averaged ECG) ventricular late potentials analysis
- QTd analysis
- hour ECG
- High Frequency ECG (HFECG)
- Frequency Cardiogram (FCECG)
- simple exercise ECG

### • 33322 CARDIOLOGY SOFTWARE to upgrade 33320 into 33321

#### TECHNICAL SPECIFICATIONS

Communication port: USB - Support HL7, Dicom interface  
 Size: 120x85x28 mm - 190 g  
 Power source: 5V DC (from PC USB port)  
 Patient insulation: 4000 V AC  
 Defibrillation protection: built-in patient cable  
 Sample rate: 10240Hz - Sample accuracy: 16 bit  
 PC minimum requirements: Windows 2000, XP Vista and Windows 7  
 CPU ≥ 1 GHz - HD ≥ 40 G - RAM ≥ 256 M

#### STANDARD ACCESSORIES

- 4 limb electrodes
- 6 chest electrodes
- Patient cable 10 leads,
- 10 electrodes
- USB pen driver
- CD software
- Banana plug

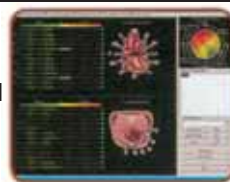

ECG CAD gram to locate coronary artery disease and ischemia



3-VCG analysis

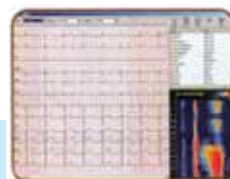

QT Dispersion QTD analysis with chroma map

Above 3 pictures refers to code 33321

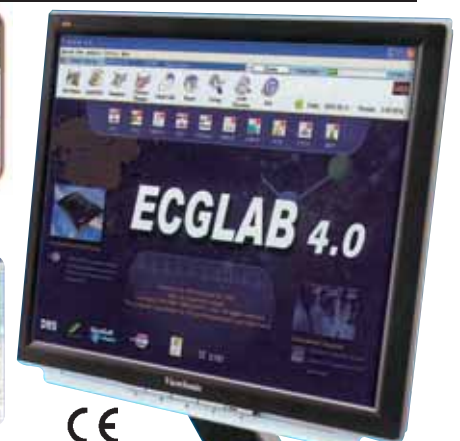

CE 0197

PC not included



Only 550 g

4 mm pins



## FIAB ECG UNIVERSAL ELECTRODES



All with silver chloride sensor and S/S snap

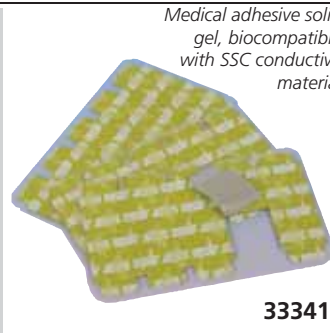

33341

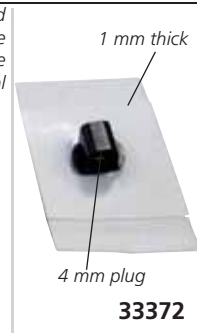

33372

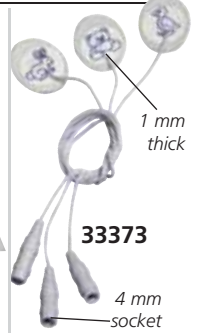

33373

GIMA code	FIAB code	Material	Size	Gel	Shape	Connection	Application	Minimum order
33313	F9089P-100	Foam	Ø 32x36 mm	Solid	Oval	Snap	Pediatric - rest, long term, stress and ECG holter	box of 2,000 pcs (20 bags of 100)
33370	F9060P	PE-Foam	Ø 40 mm	Solid	Round	Snap	Pediatric - rest, long term, stress and ECG holter	bag of 50 pcs
33314	F9089-100	Foam	Ø 36x40 mm	Solid	Oval	Snap	Adult - rest, long term, stress and ECG holter	box of 2,000 pcs (20 bags of 100)
33371	F9060	PE-Foam	Ø 48x50 mm	Solid	Oval	Snap	Adult - rest, long term, stress and ECG holter	bag of 50 pcs
33344	F9067	PE-Foam	Ø 48x50 mm	Liquid	Oval	Snap	Adult - rest, stress and ECG holter	box of 1,200 pcs (24 bags of 50)
33327	F2080	Non woven	Ø 55 mm	Solid	Round	Snap	Adult - rest ECG	box of 1,200 pcs (24 bags of 50)
33341	F3001ECG	Gelled	34x23 mm	Solid	TAB	Alligator	Adult - rest ECG	bag of 100 pcs
33372	F9047/4FL	PE-Foam	28x44 mm	Liquid	Rectangular	Plug 4 mm	Adult - rest ECG	box of 1,000 pcs (20 bags of 50)
33373	F9053N	Foam	Ø 23x30 mm	Solid	Oval	35 cm wire with 4 mm socket	Pediatric and neonatal	box of 150 pcs (5 bags of 30)

## ADAPTORS FOR ECG ELECTRODES



33367 Ø 4 mm socket



33375

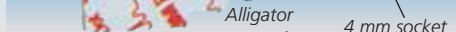

33376



33374

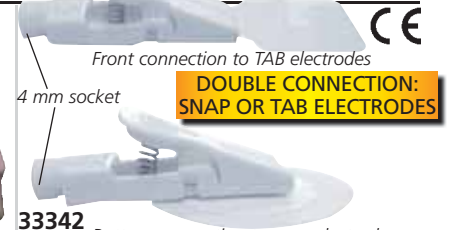

33342

**DOUBLE CONNECTION: SNAP OR TAB ELECTRODES**

GIMA code	UNIVERSAL ADAPTERS FOR ECG ELECTRODES	Minimum order
33367	Set of 10 adaptors (6 white, 1 yellow, 1 green, 1 red, 1 black) for ECG electrodes with 4 mm snap - codes 33313, 33314, 33327, 33344, 33370, 33371	set of 10 pcs
33375	Alligator adaptor with wire - total length: 16,5 cm	10 pcs
33376	Alligator adaptor	10 pcs
33342	Multifunction adaptor - can fit both snap electrodes and TAB electrodes - size 14x54x17 mm	10 pcs
33374	Grabber adaptor - fit snap electrodes - size 22.5x33 mm	10 pcs

## LIMB CLAMP AND CHEST ELECTRODES

Silver coated plastic material  
Conform to EN 60601-2-25

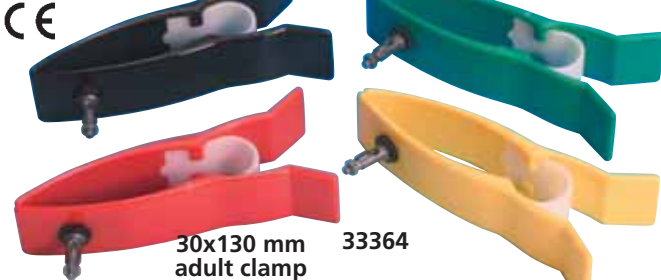

30x130 mm adult clamp 33364

20x90 mm pediatric clamp 33363



33324 Electrode Ø 30 mm

33369 Ø 30 mm

33365 Ø 24 mm

33368 Ø 15 mm

GIMA code	UNIVERSAL REUSABLE ECG ELECTRODES LATEX FREE - NICKEL FREE	Minimum order
33363	Set of 4 limb clamp electrodes (4 colours) pediatric	1 set
33364	Set of 4 limb clamp electrodes (4 colours) adult	1 set
33368	Set of 6 chest electrodes Ø 15 mm - silver coated	1 set
33365	Set of 6 chest electrodes Ø 24 mm - silver coated	1 set
33369	Set of 6 chest electrodes Ø 30 mm - silver coated	1 set
33323	Set of 6 chest electr. Ultra Ø 24 mm - silver coated	1 set
33324	Set of 6 chest electr. Ultra Ø 30 mm - silver coated	1 set

# 3M™ RED DOT™ ELECTRODES



GIMA code	3M code	3M™ RED DOT™ ELECTRODES	Minimum order
<b>Gel electrodes - short term diagnostics</b>			
33378	2330	3M™ Red Dot™ - 3.2 x 2.2 cm	bag of 100
<b>Foam monitoring electrodes</b>			
33293	2570	3M™ Red Dot™ - 4 x 3.5 cm	bag of 50
33294	2237	3M™ Red Dot™ - Ø 6 cm	bag of 50
<b>Non woven monitoring electrodes</b>			
33299	2248-50	3M™ Red Dot™ - Pediatric - Ø 4.5 cm	box of 50
33300	2271	3M™ Red Dot™ - 5.6 x 5.1 cm	box of 50
33297	2239	3M™ Red Dot™ - Ø 6 cm	box of 1,000*

**3M 2330** resting ECG electrode with adhesive gel

**3M 2570** electrode with foam tape and sticky gel - radiolucent. 5-days wearing time

**3M 2237** fluid resistant foam polyethylene backing. 3-days wearing time

**33300**



**3M 2271** diaphoretic soft cloth monitoring electrode with blue abradar 3-days wearing time

**33299**



**3M 2248-50** pediatric monitoring electrode with micropore tape backing

**33297**



**3M 2239** monitoring electrode with micropore tape backing 3-days wearing time

\*20 bags of 50 pieces

# AMBU BLUE SENSOR ECG ELECTRODES



4 mm	Tab or snap	GIMA code	AMBU code	Description	Application	Gel type	Backing material	Size (mm)	Shape	Shelf life* (month)	Radiolucent	Connector type	Minimum order	Packaging
		<b>33200</b> <b>33201</b>	SU-00-A/60 SU-00-C/100	Blue sensor SU	Resting	Wet	Polymer	49x33	Tear drop	24	No	4 mm TAB	box of 1,200 box of 1,200	20 pouches of 60 12 pouches of 100
		<b>33203</b>	L-00-S/25	Blue sensor L	Long-term	Wet	Microporous	68.2x55	Round w/offset	24	No	Snap	box of 500	20 pouches of 25
		<b>33204</b> <b>33205</b> <b>33206</b>	VL-00-S/25 VL-00-S/25 VL-00-A/25	Blue sensor VL	Long-term	Wet	Microporous	72x68	Round w/offset	24	No	Snap Snap 4mm	box of 25 box of 500 box of 500	1 pouch of 25 20 pouches of 25 20 pouches of 25
		<b>33208</b> <b>33209</b>	R-00-A/25 R-00-S/25	Blue sensor R	Stress test	Wet	Foam	57x48	Round w/offset	24	No	4mm Snap	box of 500 box of 500	20 pouches of 25 20 pouches of 25
		<b>33211</b> <b>33212</b>	M-00-A/50 M-00-S/50	Blue sensor M	Short-term	Wet	Polymer	40.8x34	Round w/offset	15	No	4mm Snap	box of 1,000 box of 1,000	20 pouches of 50 20 pouches of 50

\*Shelf life means maximum life from production date. Average Gima shelf life is 50 to 90% of maximum life

## BLUE SENSOR

BlueSensor is the world's most time and cost efficient range of electrodes that delivers unmatched readings, user convenience and patient comfort. BlueSensor ensures that you don't get your workflow disrupted by false alarms or have to waste time resolving problems with electrode adhesion.

### Exact monitoring - clear picture

Blue Sensor electrodes give a fast and reliable trace without the need for skin preparation, maximizing comfort for the patient. We know that fast, exact monitoring that ensures a clear picture of the patients' heartbeat is essential to accurate diagnoses.

### AMBU BLUE SENSOR SU

- highly conductive wet gel
- superior quick adhesion
- unique offset connector - fitting or tab

- occlusive backing material
  - high quality Ag/AgCl sensor
- ### AMBU BLUE SENSOR L
- highly conductive wet gel
  - combination of instant and long-term adhesives

- breathable microporous material
- unique offset connector

### AMBU BLUE SENSOR VL

- highly conductive wet gel
- combination of instant and long-term adhesives

- breathable microporous material
- unique offset connector

### AMBU BLUE SENSOR R

- highly conductive wet gel
- superior adhesion
- comfortable foam backing
- large measuring area



- unique offset connector
  - high quality Ag/AgCl sensor
- ### AMBU BLUE SENSOR M
- highly conductive wet gel
  - superior adhesion
  - occlusive backing material
  - unique offset connector
  - high quality Ag/AgCl sensor

# ECG GEL AND SPRAY

- **33266 ECG GEL** - 250 ml - box of 40 tubes
  - **33263 ECG GEL** - 5 l - box of 4 bags\*\*
  - **33268 ECG SPRAY GEL** - 250 ml - box of 20 tubes
- Suitable for non pre-gelled electrodes, ECG latches and pendant switches in any ECG and exertional applications. Allows ECG waves clear transfer to equipment.

It is hypoallergenic, does not irritate skin, does not contain oil and oily substances, does not contain formaldehyde and salt, has no toxic effects and is odourless.

- **33283 PUMP FOR BAG 5 l**

\*\*Includes 4 empty bottles 250 ml and 1 nozzle for easy refill



# GIMA ECG THERMAL PAPERS FOR DIFFERENT ECG BRANDS



GIMA code	ECG MANUFACTURER AND MODEL	Type	Width mm	Length m	Sheet	Marker	Grid*	Min. order
32951	ASPEL Ascard A4, B56, Mr. Blue, Mr. Silver 3 Topaz, grey, v.07.204, orange, red, v.07.303	roll	112	25	-	no	or/red	10
32996	Ascard B5 eco, Mr. Green, mint	roll	58	25	-	no	or/red	20
32952	Ascard, Mr. Gold, Gold/3 BIOCARE	roll	210	25	-	no	or/red	5
32968	101G	roll	50	20	-	no	or/red	20
32989	300G, 3010	roll	63	30	-	no	or/red	20
32969	IE3	roll	80	20	-	no	or/red	10
33002	3030, 6010	roll	112	27	-	no	or/red	10
32992	1200	roll	210	30	-	no	or/red	5
32962	1210, 1215	pack	210	140	215	yes	or/red	10
33004	IE12, IE15 BIOLIGHT	pack	210	150	200	yes	or/red	10
32969	BLT, 1203A, E 30	roll	80	20	-	no	or/red	10
32966	E70, E80 BIONET	pack	210	295	150	yes	or/red	1
32950	Cardiocare/Cardiotouch BIOSET-HORMAN	roll	215	25	-	no	or/red	5
32969	3800	roll	80	20	-	no	or/red	10
33050	Bioset 3600/3601/3700	pack	110	100	200	yes	or/red	10
33051	Bioset 8000 - 8100 - 9000 - 9100	pack	210	150	400	yes	or/red	5
32996	BTL BTL 08/MT, 08/MD, 08/MD3	roll	58	25	-	no	or/red	20
32953	08 MT, MD	roll	112	23	-	no	or/red	10
32952	BTL 08/LC, 08/LT	roll	210	25	-	no	or/red	5
32954	BURDICK Atria 3100/6100, quest CARDIOLINE	pack	210	300	200	yes	or/red	1
32955	Elan 100	pack	112	100	300	yes	or/red	25
32956	Delta 1 plus	pack	60	100	300	yes	or/red	25
32957	Delta 1 plus	roll	60	30	-	no	or/red	20
32958	Delta 3 plus	pack	112	100	300	yes	or/red	25
32959	Delta 30	roll	183	30	-	no	or/red	5
32960	Delta 60 plus	roll	210	30	-	no	or/red	5
32961	Elan 2100, Delta 612	pack	210	280	200	yes	or/red	1
33053	ECG 100+	pack	100	150	200	yes	or/red	10
33054	AR2100 (VIEW/ADV) - 66010042	pack	210	140	200	yes	or/red	8
33055	ECG 200+	pack	210	295	180	yes	or/red	1
32963	CAREWELL ECG-1101B, 1101C, 1101G	roll	50	25	-	no	or/red	20
33025	ECG-1103B, 1103G, 1103L	roll	63	30	-	no	or/red	20
33058	ECG-1103GW, 1103LW	roll	80	30	-	no	or/red	10
33059	ECG-1106G, 1106L	roll	112	25	-	no	or/red	10
32950	ECG-1112L, 112M, T/12 COMEN	roll	215	25	-	no	or/red	5
32969	CM300	roll	80	20	-	no	or/red	10
32965	CM600	roll	110	20	-	no	or/red	20
32992	CM 1200 A/B	roll	210	30	-	no	or/red	5
32966	CM 1200 A/B CONTEC	pack	210	295	150	yes	or/red	1
32968	90A, 100G	roll	50	20	-	no	or/red	20
32969	300G, 300GT	roll	80	20	-	no	or/red	10
32970	600G	roll	110	20	-	no	or/red	10
32967	1200, 1201 DIMED	roll	210	30	-	no	or/red	5
32963	LTD400	roll	50	25	-	no	or/red	20
32996	LTD410, Heartscreen 60G	roll	58	25	-	no	or/red	20
32964	LTD405S, LTD405W, LTD415 Heartscr. 80G	roll	80	25	-	no	or/red	10
32951	LTD418, Heartscreen 112	roll	112	25	-	no	or/red	10
32965	LTD440, LTD445/S	pack	110	140	143	yes	or/red	20
32960	LTD450, LTD455/S, LTD455/W	roll	210	30	-	no	or/red	5
32966	LTD450, LTD455/S, LTD455/W EDAN	pack	210	295	150	yes	or/red	1
32963	SE-1	roll	50	25	-	no	or/red	20
32964	SE-3	roll	80	25	-	no	or/red	10
32965	SE-601	pack	110	140	143	yes	or/red	20
32966	SE-6, 12, 1200 EXP	pack	210	295	150	yes	or/red	1
32960	SE-6, 12, 1200 EXP	roll	210	30	-	no	or/red	5
32962	SE/1201	pack	210	140	215	yes	or/red	10
32971	ELETTRONICA TRENTINA/CARDIETTE/CARDIOLINE Autorulor 12/1, comp. 1x12	roll	50	30	-	yes	blue	20
32972	Start 100	roll	130	27	-	yes	blue	10
32973	AR 600	roll	60	15	-	yes	blue	25

GIMA code	ECG MANUFACTURER AND MODEL	Type	Width mm	Length m	Sheet	Marker	Grid*	Min. order
32977	AR 600 Adv	pack	60	75	250	yes	blue	25
32974	AR 1200	roll	120	18	-	yes	blue	10
32978	AR 1200 (View/Adv)	pack	120	100	300	yes	blue	10
32975	Daedalus, AR2100	roll	210	20	-	yes	blue	5
32976	Daedalus, Start 200, AR2100 ESAOTE BIOMEDICA	pack	210	150	200	yes	blue	8
32980	P 80 base	roll	90	28	-	no	or/red	10
32981	P 80 base	pack	90	70	400	yes	or/red	25
32982	P 80 Power, P 80 SIX	pack	210	280	215	yes	or/red	1
32983	P8000 base	pack	80	70	300	yes	or/red	20
32984	P8000 Power	pack	210	280	200	yes	or/red	1
32985	Archimed 4240, Archiwin	pack	210	300	200	yes	or/red	1
32986	Personal 120	pack	126	150	170	yes	white	20
32987	My Cardiopad base	pack	114	90	200	yes	or/red	20
33040	Esaote my Cardiopad 2157036	pack	210	140	180	yes	or/red	5
32988	FUKUDA ME - FUKUDA DENSHI 501A, FX121, FCP-500, OP18TE	roll	50	30	-	no	or/red	20
32989	FCP15, FCP11, OP110TE, OP19TE FCP2101, 2155, FX 2111, CASE10, FCP 7101, FX 7102	roll	63	30	-	no	or/red	20
32994	OP/358TE, FCP/131, FX3010, FX3101, FX-8822	roll	145	30	-	no	or/red	10
32990	OP 111 TE, OP 115 TE, FX102	pack	50	75	400	yes	or/red	20
32991	OP 112 TE, FX2111, FX7101, FX 7102, FCP 2201 G	pack	63	75	400	yes	or/red	25
32992	FCP231, OP69TE, FX7402, FX7542, FX 8322	roll	210	30	-	no	or/red	5
32993	OP/382TE, FX-3010, FX-8222	pack	145	75	400	yes	or/red	10
32965	OP222TE, FX7202 GIMA	pack	110	140	143	yes	or/red	20
32996	Cardiogima 1M, 3M	roll	58	25	-	no	or/red	20
32953	Cardiogima 6M, colour	roll	112	23	-	no	or/red	10
32950	Cardiogima 12, 12M HEWLETT PACKARD	roll	215	25	-	no	or/red	5
32999	Page Writer 100/200, M1709A, M2483A	pack	210	300	200	hole	or/red	1
32988	40453 A, 43120 INNOMED	roll	50	30	-	no	or/red	20
32996	HeartScreen IKO 3, HeartScreen 60 IKO, 60 G	roll	58	25	-	no	or/red	20
32964	HeartScreen IKO 80G-L, 80C-L	roll	80	25	-	no	or/red	10
32953	HeartScreen 112 C-D KENZ - SUZUKEN	roll	112	23	-	no	or/red	10
33002	Cardico 302/601	roll	112	27	-	no	or/red	10
33003	Cardico 302/601	pack	112	90	200	yes	or/red	20
32960	Kenz-Cardico 1210, 1211	roll	210	30	-	no	or/red	5
32988	103, R50-30R, TEC 8300 MARQUETTE - HELLIGE - GE	roll	50	30	-	no	or/red	20
33010	MAC PC	roll	108	23	-	no	or/red	10
33011	Case 10-12-15, MAC 3000-5000	pack	215	280	300	hole	or/red	1
32966	Cardiosmart, MAC 1200/1600	pack	210	295	150	yes	or/red	1
33012	MAC 400, MAC 600	pack	80	90	280	yes	or/red	25
33013	MAC 800 MINDRAY	pack	110	140	200	yes	or/red	25
33014	Beneheart R3	roll	80	20	-	no	or/red	10
33016	Beneheart R3	pack	80	70	200	yes	or/red	25
32966	BeneHeart R12 MORTARA	pack	210	295	150	yes	or/red	1
33017	Eli 50	pack	50	70	200	yes	or/red	25
33010	Eli 100	roll	108	23	-	no	or/red	10
33019	Eli 210, 250, 280, 350, 380	pack	210	300	250	yes	or/red	1
33020	Eli 150	pack	108	140	200	yes	or/red	25
33021	Eli 230 NIHON KOHDEN	roll	210	20	-	no	or/red	5
33025	CARDIOFAX 8110, 9620, 1150K	roll	63	30	-	no	or/red	20
33026	Cardio-fax GEM/1250/1950, ECG-9010/9020/9022	pack	210	140	215	yes	white	10
32962	Cardio-fax GEM/1250/1950, ECG-9010/9020/9022	pack	210	140	215	yes	or/red	10
33027	GEM 9010, 9020, 9022, 1250, 1950	pack	110	140	143	yes	white	20
33028	1500, 1550, 9110, 9130, 9132, 9320, 2250 PHILIPS	pack	210	295	170	yes	white	1
32998	Page Writer TC/10	roll	110	25	-	no	or/red	10
32999	Page Writer TC/50 - TC/70	pack	210	300	200	hole	or/red	1
32997	Touch, TRIM I / II / III, Page Writer TC/20, TC/30 PROGETTI	pack	210	300	100	hole	or/red	1
32953	EPG 612	roll	112	23	-	no	or/red	10
32996	EPG Basik-pocket SCHILLER	roll	58	25	-	no	or/red	20
33037	AT 1, AT 4	pack	90	90	390	yes	green	25
32982	AT 2, CS 200	pack	210	280	215	yes	or/red	1
33038	AT 10	pack	210	140	250	yes	green	10
32983	AT 101	pack	80	70	300	yes	or/red	20
32984	AT 102	pack	210	280	200	yes	or/red	1
33039	AT 110, AT 10 Plus, AT 2 Plus	pack	210	140	150	yes	green	5
32987	Cardiomy, MS 2010	pack	114	90	200	yes	green	20
33040	Esaote my Cardiopad 2157036 SIEMENS	pack	210	140	180	yes	or/red	5
32990	Cardiostat 1	pack	50	75	400	yes	or/red	20
32991	Cardiostat 11 TRISMED	pack	63	75	400	yes	or/red	25
32989	Cardipia 201N	roll	63	30	-	no	or/red	20
33046	Cardipia 400, 406RS	roll	110	30	-	no	or/red	25
33047	Cardipia 800, 812RS	roll	215	30	-	no	or/red	5

\*or/red: grid could be orange or red colour

## SONY MEDICAL PRINTERS



Space saving design:  
154x240xh 88 mm,  
for flexible integration  
into medical carts

33968

**SONY**

- 33968 SONY HYBRID GRAPHIC PRINTER UP-X898 MD - black/white  
Produces A6 size printings in about 2 seconds, with superb print quality with 325 dpi and grey level of 256 steps. Can take both analogue video and digital signal inputs. 110-240 V AC, 50/60 Hz.

- 33993 SONY COLOUR PRINTER UP-25 MD  
High quality analogue A6 Dye. Sublimation Printer for use in medical applications. An ideal technology for making high quality, accurate photographic prints. See more info on [www.gimaitaly.com](http://www.gimaitaly.com)



33993

## SONY ORIGINAL PAPER



**SONY**

### SONY VIDEOPRINTER PAPERS

- 72726 SONY PAPER - UPP-110 HD - box of 10 rolls  
High density printing paper - 110 mm x 20 m
- 72727 SONY PAPER - UPP-110 HG - box of 10 rolls  
High glossy printing paper - 110 mm x 18 m
- 72728 SONY PAPER UPP-110S - box of 10 rolls
- 72729 SONY PAPER UPP-110HA - box of 10 rolls
- 72735 SONY COLOUR PAPER UPC-21L  
(4 ink rolls + 200 supports 144x100 mm)

## MITSUBISHI ORIGINAL PAPER

- 72740 MITSUBISHI PAPER  
K65HM-CE - box of 4



## COMPATIBLE PAPERS FOR SONY AND MITSUBISHI PRINTERS



**ULTRASOUND COMPATIBLE PAPER FOR VIDEOPRINTERS**  
Top quality thermal print media perfectly fitting Sony and Mitsubishi thermal printers.  
**Long lasting image durability for high storage durability**  
- high humidity and heat resistance for long storage  
- strong resistance to water, finger prints and ultrasound gel drops.  
**Precise, high resolution image reproduction**  
- first class colour intensity for highest black colour density  
- outstanding, bright, sharp and detailed medical image  
- high glossy, brilliant, photorealistic reproduction  
**Trouble-free printing and long-term use of printer**  
- easy tearing along the cross direction  
- minimum curling for flat photo media and easy filing  
- built-in anti-electrostatic layer preventing thermal head damage.

GIMA code	SONY	Compatibility MITSUBISHI	Paper grade	Size mm x m	Minimum order
72745	UPP-110HG	K91HG/KP91HG	high glossy	110x18	box of 5
72746	UPP-84HG	-		84x12.5	box of 10
72747	UPP-110HD	-	high density	110x20	box of 5
72748	-	K65HM/KP65HM		110x20	box of 5
72749	UPP-210HD	-		210x25	box of 5
72750	UPP110S	-	standard	110x20	box of 5
72751	-	K61S/KP61S/KP61B		110x20	box of 5



## COMPATIBLE DEFIBRILLATOR ECG THERMAL PAPER - DIFFERENT BRANDS

GIMA code	MANUFACTURER AND MODEL	Type	Width mm	Length m	Sheet	Marker	Grid*	Min. order	GIMA code	MANUFACTURER AND MODEL	Type	Width mm	Length m	Sheet	Marker	Grid*	Min. order
33100	CORPLUS Corplus 3 MINDRAY	roll	106	20	-	no	or/red	10	33102	PHILIPS Defibrillator MRX	roll	75	25	-	no	or/red	10
32968	Beneheart D3, D6 HEWLETT PACKARD	roll	50	20	-	no	or/red	20	33103	Heartstart XL	roll	50	30	-	no	or/red	20
33103	40457C/D, Codemaster 100, XL NIHON KOHDEN	roll	50	30	-	no	or/red	20	33032	PHYSIO CONTROL Life Pack 8-9-10	roll	50	23	-	no	or/red	20
33029	Def. TEC 5521, 5531, BSM 2300, 3000	pack	50	100	200	no	or/red	25	33033	Life pack 11-12-15 SCHILLER	roll	107	25	-	no	or/red	10
32988	Tech-8300	roll	50	30	-	no	or/red	20	32983	Defigard 6002 ZOLL	pack	80	70	300	yes	or/red	20
									33106	Defi/1400 (P/N 8000-0300)	pack	90	90	200	yes	or/red	20

\*or/red: grid could be orange or red colour

## GIMA ULTRASOUND GEL



GIMA code	ULTRASOUND GEL	Minimum order
33269	Sterile ultrasound gel - sachet - 20ml - transp	box of 48
33271	Ultrasound gel - sachet - 20ml - transparent	box of 200
33270	Ultrasound gel - tube 60 ml - transparent	box of 12
33272	Ultrasound gel - tube 250 ml - blue	box of 40
33273	Ultrasound gel - tube 250 ml - transparent	box of 40
33274	Ultrasound gel - bottle 1 l - blue	box of 12
33275	Ultrasound gel - bottle 1 l - transparent	box of 12
33276	Ultrasound gel - tank 5 l - blue	box of 2*
33277	Ultrasound gel - tank 5 l - transparent	box of 2*
33278	Ultrasound gel - bag 5 l - blue	box of 4**
33279	Ultrasound gel - bag 5 l - transparent	box of 4**
33283	Pump for tank 5 l and bag 5 l	

\*includes 2 empty bottles 250 ml \*\* includes 4 empty bottles 250 ml and 1 nozzle

### GIMA ULTRASOUND GEL

Hypoallergenic, water soluble gel suitable for ultrasonography, doppler and defibrillator applications. It ensures the ultrasound waves come to the equipment display in a clear and uninterrupted way. Salt, formaldehyde, fragrance free.



## GEL CLEANER

- 33281 GEL PROBE CLEANER 250 ml 33281

It removes the gel left over the probe, makes the image clearer and extends the probe life. Thanks to the active agents contained, it prevents the bacteria to pass from patient to patient, and it ensures hygiene. Alcohol-free.



## COSMETIC GEL

- 33254



## TECARTHERAPY CREAM

- 33251 TECARTHERAPY CREAM 1 l 33251

It allows to reduce the contact impedance between the probe and the skin. The high conductivity ensures the best results both in the capacitive phase and in the resistive phase of the treatment. Preservatives and dyes used are non-toxic. Latex free.



## EEG PASTE

- 33262 EEG PASTE - 400 g 33262

Used with EEG electrodes in EEG application for brain mapping. Thanks to the active substances in its content, it allows the electrode to cling to the strand of hair easily and provides conductivity. It is hypoallergenic, does not irritate skin, soluble in water and can be cleaned easily. Does not contain oil and oily substances. It has no toxic effects and odour.



### KONIX COSMETIC LASER & CAVITATION GEL

Laser & Cavitation gel reduces the pain that patients experience during depilation and makes the device last longer by cooling the device head and window. Thanks to the vacuum technology, its active substances and its high viscosity it preserves probe from damages. It is not affected by the body salt during the use, ensures an easy application.

**Technical properties:** it is hypoallergenic, does not irritate skin, is water soluble and easily cleanable. Oily substances, formaldehyde and salt free. No toxic effects and odourless.

GIMA code	COSMETIC LASER & CAVITATION GEL	Minimum order
33253	Cosmetic gel - tube 250 ml	box of 40
33254	Cosmetic gel - bottle 1 l	box of 12
33255	Cosmetic gel - bag 5 l	box of 4**
33283	Pump for bag 5 l	

\*\* includes 4 empty bottles 250 ml and 1 nozzle for easy refill

# GIMA PORTABLE, BIDIRECTIONAL, VASCULAR DOPPLER

- **33230 GIMA BIDIRECTIONAL DOPPLER NON STEREO with two probes: 4 and 8 MHz**  
Continuous wave (CW) bidirectional doppler equipped with electronic probes for high sensitivity and low background noise.
  - bidirectional graphic separation of flow (forward and reverse)
  - LCD graphic display for real time display of forward and reverse flow in bidirectional or separate mode
  - selectable amplitude scale: 1, 2, 4, 8 kHz during the test and before printing. Preset zero line
  - 5 minutes (300 sec.) continuous and reviewable memorized test. Operator can select the most meaningful exam and print it.
  - calculation of: heart rate, peak flow and mean flow
  - simultaneous connection of high sensitivity probes
  - internal rechargeable large capacity battery (Ni-Cd 1.8 Ah); the system can be operated during charging. Autonomy 8 hours
  - footswitch for freezing or memorizing the graphs
  - hardcopy may or may not include the parameter calculation
  - printing time scale: 25 mm/s
  - Hi-fi audio output for correct acoustic diagnosis

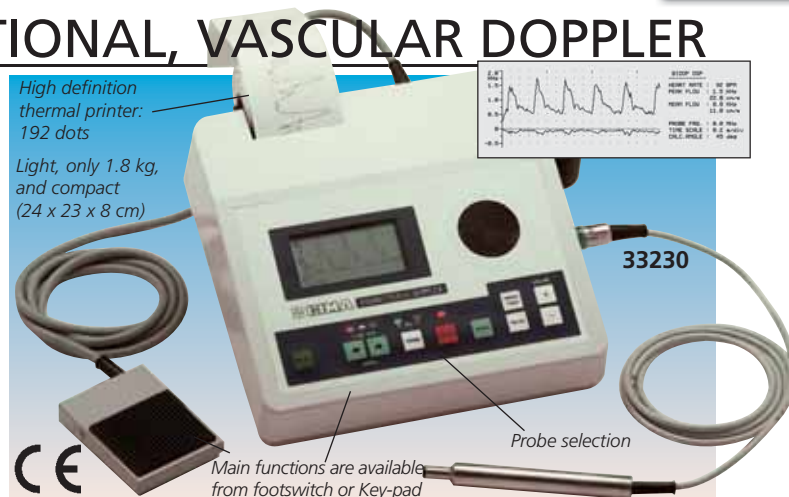

- **33240 GIMA BIDIRECTIONAL PROBE 4 MHz - spare for 33230**
- **33241 GIMA BIDIRECTIONAL PROBE 8 MHz - spare for 33230**
- **33250 THERMAL PAPER 58 mm x25m (pack of 5 rolls)**

# POCKET DOPPLER WITH INTERCHANGEABLE OR FIXED PROBES



TECHNICAL SPECIFICATIONS	
<b>Ultrasound</b>	<b>Power supply</b>
Frequency: 2, 5 or 8 MHz continuous wave	Battery 9V Alkaline (not included)
Transducer: 2 crystal narrow beam	Expected battery life: >9 hours
Output power: <15mW/cm <sup>2</sup> SATA	<b>Output</b>
Audio Response: 300Hz - 4 KHz	Headset: Audio output to optional headset (not included)
<b>Unit Controls</b>	Material: ABS / Noryl
Keys: 1 Key (for unit on/off)	Size - weight: 150 mm by 75 mm - 299 g
Controls: rotary volume	Classification: Class I Type B - IEC 60601-1
Indicators: Yellow battery low LED	

## GIMA POCKET DOPPLERS

Small, lightweight, high sensitivity pocket Doppler. Its probes are ideal for use by a General Practitioner, vascular specialist for routine vascular examination in ER for vessel location, or by specialists in diabetes, urology and gynaecology. Vascular flow signals and FHR are easily located using the transducer while internal signal processing minimizes noise artefacts. The flow signal is also available to the user via the built-in loudspeaker with output level controlled by rotary volume control. 2 years warranty. Supplied in a nice bag with probe, cable, gel tube and 7 languages user manual: GB, FR, DE, IT, ES, GR, PT.

GIMA code	GIMA POCKET DOPPLERS
33120	DOPPLER V2005 with 5 MHz fixed vascular probe
33121	DOPPLER V2008 with 8 MHz fixed vascular probe
33123	DOPPLER V2000 (without probe)
33126	2 MHz interchangeable probe - foetal for V2000
33127	5 MHz interchangeable probe - vascular for V2000
33128	8 MHz interchangeable probe - vascular for V2000
29511	ON/OFF membrane switch spare for 33120/3

# SONOTRAX DOPPLERS



GIMA code	DOPPLERS AND INTERCHANGEABLE PROBES - LATEX FREE
29490	SONOTRAX LITE DOPPLER - without probe - with bag
29491	SONOTRAX BASIC DOPPLER - with display - without probe - with carrying bag
29493	SONOTRAX PRO II DOPPLER with backlit display built-in audio recorder and rechargeable batteries, battery charger, carrying bag, without probe
29496	2MHz waterproof probe - gynaecology
29497	3MHz waterproof probe - gynaecology
29498	4MHz waterproof probe - vascular
29499	8MHz waterproof probe - vascular

# SONOLINE COLOUR DOPPLER

- **29480 COLOUR SCREEN POCKET DOPPLER**
  - portable and lightweight
  - built-in speaker
  - TFT-LCD, real-time display of FHR
  - three working modes: real-time FHR, average FHR and manual calculation
  - display of FHR, bar graph and heart-beat waveform, red alarm for abnormal FHR
  - low power consumption, continuously work for more than 8 hours with two "AA" batteries LR6 - 1.5 VDC
  - indication for probe-off and low battery
- **29481 2 MHz WATERPROOF PROBE - gyn**
- **29482 3 MHz WATERPROOF PROBE - gyn**
- **29483 4 MHz WATERPROOF PROBE - vascular**
- **29484 8 MHz WATERPROOF PROBE - vascular**



TECHNICAL SPECIFICATIONS		
Ultrasound working frequency:	2 MHz ± 10%	
Fetal heart rate:	range: 50-240 bpm	accuracy: ± 2 bpm
	resolution: 1 bpm	
Alarm:	high limit: 160 bpm	low limit: 120 bpm
Ultrasound intensity:	< 5 mm/cm <sup>2</sup>	
Auto power off after 1 minute no signal		
Dimension - weight:	135x92x29 mm - 245 g	

# MINDRAY DP-10 AND DP-20 DIGITAL ULTRASOUND SYSTEM

## DP-10 slim and smart

Good image quality, easy to use and lightweight to take it anywhere. It combines fashionable design, diagnostic confidence and economy.

## DP-20 exceeds your expectations

Smart portable B/W ultrasound system with advanced features

### Display modes and imaging processing:

Broadband, multi-frequency imaging: B, B/B, 4B, B/M, M

### Imaging processing:

- multi-frequency probes for 2D imaging modes -
- iClear: speckle reduction image
- THI (Tissue Harmonic Imaging) with convex probe 33976 only

- TSI (Tissue Specific Imaging)

- zoom function: spot zoom, pan zoom

- ExFOV (Extended field of view)

Extended view of the anatomical structure on all convex and linear probes allow to discover better diagnostic information.

- iTouch (Auto image optimization)

### User interface

- alphanumeric QWERTY keyboard with backlight
- trackball: speed presettable
- 8-segment TGC
- user defined blank keys: shortcut for easy access to menus

### iStation™ intelligent workflow

Intelligent patient data management system

- integrated search engine for patient data
- detailed patient information review
- intelligent data backup/restore
- patient data/image sending, data deleting (USB, DVD, DICOM)
- exam managing: activate exam

### Storage/review mode:

- image archive on hard disk and USB mobile storage medium, temporary saving in cine memory, directly transfer report to PC
- 2 USB ports
- multiple image formats: BMP, JPG, DCM, FRM, AVI, DCM, CIN
- iVision: demo player
- Cine review: auto, manual (auto review segment can be set), supports linked cine review for 2D, M images
- Cine memory capacity (max.)
- clip length presettable: 1-60 s

B mode: 11959 frames M mode: 110.0 s

Supplied with GB, IT manual and CD manual (GB, FR, IT, ES, PT, DE, RU, BR).

GIMA code	DIGITAL ULTRASONIC DIAGNOSTIC IMAGING SYSTEM	
33970	MINDRAY DP-10 B/W system with 1-probe connector, 12.1" high resolution LED monitor, 2 USB port, 1 VGA OUT port, 1 video OUT, 1 S-Video OUT, software, without probe	
33971	MINDRAY DP-20 portable B/W system with 1-probe connector, 12.1" high resolution LED monitor, 2 USB port, THI, iStation™, software package, without probe	
PW DOPPLER		
33969	PW (Pulse Wave) doppler for probes 33976, 33977	
ACCESSORIES		
33875	Needle guided brackets for Linear probe (33977, 33983)	
33876	Needle guided brackets for Micro-convex probe (33979, 33984)	
33974	Lithium-ion rechargeable battery for DP-20	
33985	Carrying bag for DP-10, DP-20, DP-30	
33986	UMT-110 mobile trolley for DP-10, DP-20, DP-30	
33968	SONY HYBRID GRAPHIC PRINTER X898 MD	

PROBES DP-10 - DP-20		FREQUENCY (MHz)		● Main application										
GIMA code	Mindray code	Scanning method	Main freq.	Probe band width	ABDOMINAL	OB / GYN	UROLOGY	SMALL PARTS	CARDIOLOGY	MSK	VASCULAR	PEDIATRIC	ORTHOPEDICS	INTRAOPERATIVE
33976	35C50EB	Convex	3.5	2.0 - 5.0	●	●	●	●	●	●	●	●	●	●
33977	75L38EB	Linear	7.5	5.0 - 10.0	●	●	●	●	●	●	●	●	●	●
33978	65C15EA	Micro-convex	6.5	5.0 - 8.5	●	●	●	●	●	●	●	●	●	●
33979	65EC10EB	Micro-convex	6.5	5.0 - 8.5	●	●	●	●	●	●	●	●	●	●
33980	35C20EA	Micro-convex	3.5	2.0 - 5.0	●	●	●	●	●	●	●	●	●	●
33983	75L53EA	Linear	7.5	5.0 - 10.0	●	●	●	●	●	●	●	●	●	●



### iScanHelper function

Dedicated inbuilt tutorial function to enhance ultrasound experience.

- wide selection of application specific exam planes
- anatomical illustrations
- standard ultrasound images
- scanning reference pictures
- tips on scanning and diagnosing

### Optional PW doppler for probes 33976 (Convex), 33977 (Linear)

DP-10/20 support superb PW Doppler imaging to access blood flow in different clinical conditions.

With PW, doctors will be able to:

- differentiate non echoarea and blood vessels
- distinguish arteries and veins
- evaluate blood flow velocity for more comprehensive diagnosis
- Check the health of a fetus by blood flow evaluation of the umbilical cord

### Features

Parameter adjustment: Gain, Sample volume size, Scale, Steer, Dynamic range, Wall filter, etc.

Measurement: Trace, HR, Velocity, PS/ED, PI, RI, etc.

33985



TECHNICAL SPECIFICATIONS	
Dimension:	16x29xh 35.4 cm (6.3"x11.4"xh 13.9")
Weight:	5.1 kg
Display:	12.1" LED, high-resolution 1024x768
Display language:	DP-10, DP-20: GB, FR, DE, IT, ES, PT, RU, CZ, PL
Power:	AC100-240 V, 50-60 Hz
	Rechargeable lithium-ion battery (DP-20 only) - on request



# MINDRAY DP-50 DIGITAL ULTRASOUND DIAGNOSTIC SYSTEM



**33973 + 33988**

Supplied with GB, IT manual and CD manual  
GB, IT, FR, DE, RU, ES, PT, BR.

- **33973 MINDRAY DP-50 PORTABLE ULTRASOUND with 15" high resolution LCD monitor, 2 probe connectors, 320GB hard disk, 4 USB ports, multiple software package, without probes. Imaging mode: B, B/B, 4B, B/M, M**  
**Image processing technology:**
  - Phase Shift Harmonic Imaging
  - Tissue Harmonic Imaging
  - iBeam™ Spatial Compound Imaging
  - iClear™ Adaptive Speckle Suppression Imaging
  - iTouch™ Auto Optimization
  - Trapezoid imaging
  - iZoom™ Automatically expand the image to full screen
  - Slant scanning for linear probes (2D Steer)**Wideband multifrequency probes: continuously adjustable 2-14 MHz**  
**Intelligent Workflow/Storage/Review:**
  - iStation™ Intelligent patient data management system
  - 320 GB integrated hard disk for storage
  - 4 USB ports
  - Cine memory capacity (Max.) B mode: 10566 frames
  - M mode: 66.3 s
- **33972 MINDRAY DP-50 PT PORTABLE ULTRASOUND PHYSIOTHERAPY PRESET with 15" high resolution LCD monitor, 2 probe connectors, 320GB hard disk, 4 USB ports, multiple software package, without probes.**  
 Same as 33973 but with real time ultrasound imaging (RTUI) for physiotherapy.  
 Dedicated Physiotherapy presets: pelvic/hip/lumbar spine/shoulder/elbow/wrist/knee/ankle/Achilles tendon/cervical spine.  
 Dynamic tracking therapeutic effects with image comparison function. Optimal musculoskeletal image quality

TECHNICAL SPECIFICATIONS	
Display:	15" LCD
Display language:	GB, FR, IT, ES, PT, RU, PL, CZ, TR, FI, DK, NO, SE, DE
Power:	AC 100-240 V - 50/60 Hz rechargeable lithium-ion battery - on request
Size and weight:	19x41.5xh 37.8 cm (7.5"x16.3"xh 14.9"); 7.7 kg (17 lb)

# MINDRAY Z5 COLOUR DIAGNOSTIC ULTRASOUND SYSTEM

- **33880 MINDRAY Z5 COLOUR PORTABLE ULTRASOUND with 15" high resolution LCD monitor, 2 probe connectors, 320GB hard disk, 4 USB ports, multiple software package, without probes.**

A colour doppler system that offers a rare combination of high performance and low cost. Superior image quality, affordability, versatility and mobility in a unique portable Doppler system:

**Versatility**

- scanning modes: B, Colour, PW, Power, M, FreeXros M
- image display modes: B, 2B, 4B, B/C, B/M, B/PW, Triplex PW
- applications: ABD/OB/GYN/CAR/SML/URO/VAS/ORTH/EM/NERVE
- transducer variety : Convex, Linear, Micro-convex, Endocavity
- extended scanning angle with ExFov function
- high frequency linear probe for superficial scanning

**Productivity**

- iTouch: quick image optimization with one-click
- iZoom: instant full screen zoom with one-click
- iStation: patient database review and analysis platform
- iStorage: direct data transfer to PC
- Clipboard: easy play, preview and sharing of cineloop
- Multiple image formats : BMP, JPG, DCM, AVI, DCM, CIN

**Mobility**

- compact and streamlined design weighing 7.7kg
- 15" LCD monitor with 30 degree tilt function
- dual universal transducer connectors

- two level backlit keyboard for varying requirements
  - can be packed in a convenient hand-carried bag for easy transportation
  - 1.5 h uninterrupted scanning with rechargeable battery
- Supplied with CD manual: GB, FR, IT, ES, PT, DE, RU, BR.



**33880**

TECHNICAL SPECIFICATIONS	
Display:	15" LCD high resolution 1024x768
Software display + keyboard input:	GB, FR, IT, ES, PT, RU, PL, CZ, DE
Keyboard input:	TR, FI, DK, NO, SE
Power:	AC 100-240 V - 50/60 Hz rechargeable lithium-ion battery - on request
Size and weight:	19x41.5xh 37.8 cm (7.5"x16.3"xh 14.9"); 8.8 kg (19.4 lb)

# PROBES AND ACCESSORIES FOR DP-50 AND Z5

GIMA code	ACCESSORIES for DP-50 and Z5
33875	Needle guided brackets for Linear probe (33983)
33876	Needle guided brackets for Micro-Convex probe (33984)
33975	Lithium-ion rechargeable battery for DP-50 and Z5
33987	Carrying bag for DP-50 and Z5
33988	UMT-150 mobile trolley for DP-50 and Z5
33968	SONY PRINTER UP-X898 MD FOR DP-50
33993	SONY COLOUR PRINTER UP-25 MD FOR Z5



**33987**

Trolley size:  
44,5x53,5x  
h 81 or 87 cm

Height selectable  
(2 levels) when installing

PROBES DP-50 and Z5			FREQUENCY (MHz)		● Main application									
GIMA code	Mindray code	Scanning method	Main freq.	Probe band width	ABDOMINAL	OB / GYN	UROLOGY	SMALL PARTS	CARDIOLOGY	MSK	VASCULAR	PEDIATRIC	PROSTATE	ORTHOPEDIC
33982	35C50EA	Convex	3.5	2.0 - 5.0	•	•	•	•	•	•	•	•	•	•
33983	75L53EA	Linear	7.5	5.0 - 10.0	•	•	•	•	•	•	•	•	•	•
33978*	65C15EA	Micro-convex	6.5	5.0 - 8.5	•	•	•	•	•	•	•	•	•	•
33984*	65EC10EA	Micro-convex	6.5	5.0 - 8.5	•	•	•	•	•	•	•	•	•	•
33990*	10L24EA	Linear array	10.0	8.0 - 14	•	•	•	•	•	•	•	•	•	•
34004	75L38EA	Linear	7.5	5.0 - 10.0	•	•	•	•	•	•	•	•	•	•



**33982**



**33983**



**34004**



**33978**



**33984**



**33990**



**33988**

\*not for DP-50PT

# CHISON ECO1 AND ECO3EXP. DIGITAL ULTRASOUND SYSTEMS

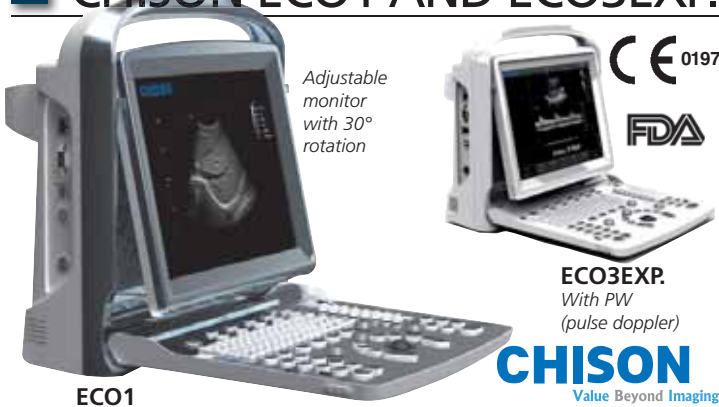

Adjustable monitor with 30° rotation

ECO3EXP. With PW (pulse doppler)

**CHISON**  
Value Beyond Imaging

DIGITAL ULTRASOUND B&W DIAGNOSTIC IMAGING SYSTEM									
GIMA code	Model	ECO1	ECO3EXP. ECO5						
33863	CHISON ECO1 with 1 probe connector without probe								
33864	CHISON ECO3EXP. with 2 probe connectors without probe								
STANDARD PACKAGE									
12" high resolution LED monitor - B&W		•	•						
12" high resolution LED monitor - colour			•						
8G memory card		•	•						
Hot Key		•	•						
PC printer connection		•	•						
3 USB port		•	•						
1 ethernet port		•	•						
1 video out port, 1 VGA out port		•	•						
1 footswitch port		•	•						
Full screen display		•	•						
2.5 hours rechargeable lithium-ion battery	optional		•						
Power adaptor		•	•						
Standard software package		•	•						
Easy View image archive system		•	•						
THI		•	•						
PW (doppler function to detect blood flow speed)		•	•						
TECHNICAL SPECIFICATIONS									
Dimension and weight: 33.5x15.5xh 35 cm (13.2"x6.1"xh 13.8"); 6 kg									
Display: 12" LED, high resolution 1024x768									
Power: AC 100-240 V - 50/60 Hz rechargeable lithium-ion battery (ECO1 option, ECO3EXP. standard)									
LANGUAGE - switchable by user									
	GB	IT	FR	ES	DE	CZ	TR	CN	RU
Software	•	•	•	•	•	•	•	•	•
User manual	•	•	•	•	•	•	•	•	•

**ECO1 Premium Design, Surprising Price**  
**ECO3EXP. Premium Black&White Model with Doppler,**  
 - ultra-compact and ultra-light weight, easy to carry  
 - latest LED screen technology, super bright images allow to easily view scan even outdoor.  
 - ergonomic monitor design, 30 degree rotation, adjustable.  
 - ultra-long battery life up to 2.5 hours, for outdoor scanning  
 - one-key to enlarge image to full screen, easy to view from distance  
 - streamlined workflow, easy to operate, 6-one-key to finish the cycle of diagnosis.

**Display modes and imaging processing**  
 B, B/B, 4B, M, B/M, PW (ECO3EXP. only) multi-frequency imaging  
**Imaging processing**  
 - compound Imaging  
 - i-image intelligent image optimization  
 - THI (Tissue Harmonic Imaging)  
 - SRA (Speckle Reduction Algorithm)  
 - full digital beam-former  
 - full screen display

**User interface**  
 - fold-up control panel and alphanumeric keyboard  
 - back-lit keyboard for good visibility in dark room  
 - interactive back-lighting  
 - indicator lights identify activated keys  
 - 8 TGC slides for easy adjustment  
 - short cut knob for quick adjustment (hot key user- defined)  
 - neat and clear keyboard layout, doctor can remember easily  
 - user defined preset

**Streamlined workflow, one key to:**  
 - select desired application with automatic preset  
 - optimize the image automatically (AIO)  
 - save still image and CINE loop  
 - print to PC printer\* (laser or inkjet) or video printer  
 \*See list of compatible printers on our websites

**EASYVIEW™ Archive system**  
 - image archive on hard disk and USB mobile storage  
 - 3 USB ports  
 - multiple image formats: BMP, JPG, DCM, CIN, AVI  
 - cine review: auto, manual (auto review segment can be set for 2D, M, PW (ECO3EXP. only) images  
 - cine memory capacity (256 frames/10s)

# CHISON ECO5 COLOUR DOPPLER DIGITAL ULTRASOUND SYSTEM

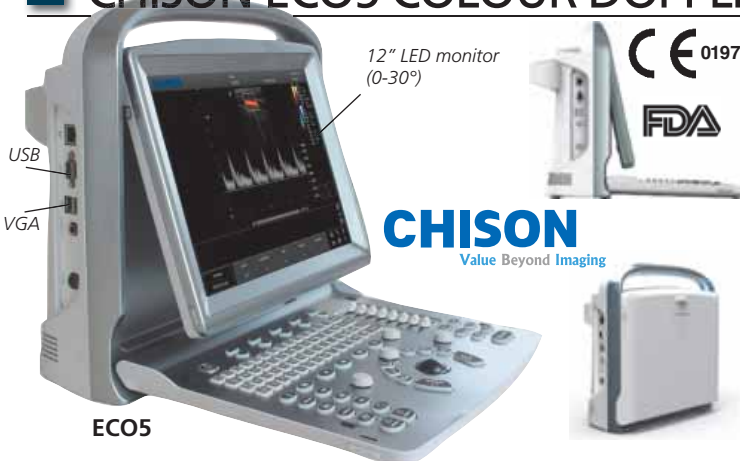

12" LED monitor (0-30°)

**CHISON**  
Value Beyond Imaging

• 33865 CHISON ECO5 Colour Doppler 12" high resolution color LED monitor, 8G high speed memory, 3 USB ports, 2 probe connectors, EASYVIEW™ archive system, without probe  
**Imaging model: B, B/B, 4B, B/M, M, CFM, PW**

**Imaging processing:**  
 - MCI (Multiple Compound Imaging)  
 - i-image intelligent image optimization  
 - THI (Tissue Harmonic Imaging)  
 - SRA (Speckle Reduction Algorithm)  
 - full digital beam-former  
 - full screen display model  
 - AIO (Automatic Image Optimization)

**Other specifications as ECO3EXP.**  
**TECHNICAL SPECIFICATIONS**  
 Dimension and weight: 33.5x15.5xh 35 cm (13.2"x6.1"xh 13.8"); 6.5kg  
 Display: 12" LED, high-resolution colour 1024x768  
 Power: AC 100-240 V, 50-60 Hz  
 Rechargeable lithium-ion battery

# PROBES AND ACCESSORIES FOR CHISON ECO SERIES

PROBES ECO1 - 3 - 5					FREQUENCY(MHz)					Main application				
GIMA code	CHISON code	Scanning method	Main freq.	Probe band width	ABDOMINAL	OB&GYN	UROLOGY	SMALL PARTS	BASIC CARDIOL.	MSK	VASCULAR	PEDIATRIC	ORTHOPAE.	
33998	C3-A	Convex	3.5	2.5 - 5.0	•	•	•	•	•	•	•	•	•	
33999	L7M-A	Linear**	7.5	5.3 - 10.0	•	•	•	•	•	•	•	•	•	
33871	L7S-A	Linear***	9.0	5.3 - 11.0	•	•	•	•	•	•	•	•	•	
33872	V6-A	Trans-vaginal	6.0	4.5 - 8.0	•	•	•	•	•	•	•	•	•	
33997	MC6-A	Micro-convex	6.0	4.5 - 8.0	•	•	•	•	•	•	•	•	•	
33873*	R7-A	Trans-rectal	7.5	5.0 - 10.0	•	•	•	•	•	•	•	•	•	
33874	MC3-A	Micro-convex	3.0	2.5 - 5.0	•	•	•	•	•	•	•	•	•	

\*For ECO3EXP. and ECO5 only \*\*With 40 mm footprint, general linear probe  
 \*\*\*With 30 mm footprint for superficial tissue exams with higher resolution

GIMA code	ECO SERIES ACCESSORIES
33869	Rechargeable lithium-ion battery BT-2500 (2.5 hours)
33867	ECO trolley TR-9000
33868	Carrying bag
33866	Needle guided brackets - specify for which probe (for 33998-9, 33872-4 only)
PRINTERS	
33968	SONY UP-X898 MD B&W printer (for ECO1 and ECO3EXP.)
33993	SONY UP25MD colour printer(for ECO5)



# CHISON QBit5 AND i8 ECO-COLOUR DOPPLERS



• **33877 QBit5 ECO-COLOUR DOPPLER** - 15" flat high resolution LED monitor. Supplied with 2 probe connectors and 1 parking probe connector, trolley, keyboard, large image storage: 32 GB HardDisk, 6 USB ports, VGA format, without probes. Affordable and reliable colour doppler with advanced technologies: compound imaging, quad beam former imaging, Q-image, Q-flow, X-contrast providing superb images. The Streamlined workflow and ergonomic outlook design improve work efficiency.

**Imaging modes:** - Power Doppler / Directional PD - B/BC - CFM - PW mode - CW mode - full screen - duplex, triplex - chroma B/M/PW/CW - B, 2B, 4B, B/M, M *Four chambers view, B/BC mode* - trapezoidal on linear probe

**Image processing technology:**  
 - Speckle Reduction Algorithm (SRA)  
 - direct print to PC or video printer  
 - automatic image optimizer (AIO)  
 - fusion harmonic imaging (FHI)

**Special radiology function:** 2D steer and super needle (optional)  
**Phased array probe and package**  
 Phased array probe functions include CW, TDI, ECG, Colour M and complete calculation packages including PISA/Dp/Dt

• **33965 i8 ECO-COLOUR DOPPLER** - 19" flat high resolution monitor  
 Supplied with 4 probe connector, trolley, keyboard, large image storage: 500 GB HardDisk, 6 USB port, DVD-RW, VGA format, I-image, Cardiac Package, without probes. Digital colour Doppler System with professional features: I-IMAGE improves image quality and offers ECG Intelligent I-image optimization.

**Imaging mode:**  
 - B, 2B, 4B, B/M, M  
 - CFM, Power doppler, Directional PD - B/BC mode  
 - PW mode, CW mode (with cardiac probe) - panoramic  
 - instant triplex, duplex, quadplex  
 - trapezoidal on linear probe - chroma B/M/PW/CW

**Image processing technology:**  
 - Tissue Harmonic Imaging (THI) on all probes  
 - Speckle Reduction Algorithm (SRA)  
 - Multiple Compound Imaging (MCI)

**Wideband multifrequency probes**  
 Continuously adjustable, 2.5-12 MHz  
 Operating voltage: 100-240 V, 50-60 Hz

**Cardiac Package (colour M, CW, steering M, ECG, TDI, IMT)**  
 • **33966 i8 ECO-COLOUR DOPPLER+4D PROBE AND PACKAGE**  
 Same as 33965 but with 4D real time imaging composed of 3D pictures with addition of live motion and probe 4D convex (33959).  
 • **33993 SONY UP - 25 MD COLOUR PRINTER A6** for i3, i8, QBit5  
 • **33968 SONY UP-X898 B/W PRINTER** for i3, i8, QBit5

GIMA code for QBit5	GIMA code for i8	PROBES Scanning Method	FREQUENCY (MHz)			Main application								
			Main freq.	Probe band width QBit5	Probe band width i8	ABDOMINAL	OB/GYN	UROLOGY	SMALL PARTS	CARDIOLOGY	TCD	PEDIATRICS	VESSELS	
33953	33953	CONVEX	3.5	2-6.8	2.5-5.3	●	●							
33955	33955	LINEAR	7.5	4-15	5-10			●						●
33956	33956	MICRO-CONVEX (TRANSVAGINAL)	6.0	4-12	4-10.7		●							
33964	33964	MICRO CONVEX (BASIC CARDIAC)	3.0	2-6.8	2.5-6.4					●			●	
-	33963	CARDIAC (PHASED ARRAY)	3.0	-	2.5-4					●				
33879	-	CARDIAC (PHASED ARRAY)	3.0	1.5-5.3	-					●	●			
33958	33958	PEDIATRIC	5.0	4-10.7	3.5-8									●
-	33959*	4D CONVEX	4.5	-	2.2-6.4	●	●							

\*Spare for 33966



# CHISON 600M PORTABLE ULTRASOUND



• **33930 CHISON 600M PORTABLE ULTRASOUND**  
 10" SVGA monitor with two probe connectors, 256 frames cine memory, USB port, VGA port, without probes  
 - zooming and measurement functions (max scanning depth: 252 mm)  
 - wide applications: GYN, urology, abdominal, small parts  
 - 4-steps sweep speeds for cardiac study: 2s, 4s, 6s, 8s  
 - 4-steps zoom with depth control: x0.8, x1.0, x1.5, x2.0

- various measurements: distance, circumference, area, volume  
 - full Ob/Gyn software included: 7 EDD tables (BPD, GS, FL, AD, HC, AC, CRL), G.A. (fetal age) from 4-43 weeks  
 - fetal weight, fetal heart rate measurement  
 - imaging reversing: up/down, left/right, positive/negative  
 - power supply: 110-230 V, 50-60 Hz  
 • **33968 SONY PRINTER UP-X898 MD** • **33901 TROLLEY FOR 33930**

GIMA code	Outlook	PROBES Scanning Method	FREQUENCY (MHz)		Main application						
			Main freq.	4-Step Multi-frequency	ABDOMINAL	OB/GYN	UROLOGY	SMALL PARTS	BREAST	VESSELS	
33932		CONVEX	3.5	2.5/3.5/4.0/5.0	●	●	●				
33933		LINEAR	7.5	5.0/6.0/7.5/9.0				●	○	●	

Lightweight: only 7 kg (size: 42x27x25 cm)

# SONOTOUCH™ 10.4" TOUCH ULTRASOUND COLOUR DOPPLER

• **33919 SONOTOUCH™ 30** - colour doppler with built-in probe connector, 10" high contrast LED monitor, 16 G memory, 3 USB port, video, LAN port, without probe. Lightweight, portable, small size, touchscreen ultrasound devices.

**Main features:**

- display mode: B, B/B, 4B, B/M, M, Colour and PW mode. In the M or B/M mode, 4 steps sweep speeds.
- multi-step display magnification, depth enhancement
- setting adjustment of total gain, and 8 segments of TGC slides for selection and adjustment
- multifocal firing focus, edge enhancement, frame averaging, compound
- image freezing and storage function, built-in 16 GB high-speed memory and external USB memory disk can be connected to the system for mass storage through USB port. Stored images can be retrieved for analysis.
- 256 frames of real-time images can be stored in Cine-memory
- probe scanning direction can be changed and the image can be reversed in left/right, up/down direction
- measurements of distance, area, circumference, volume, OB etc. Automatic calculation of OB and cardiology. Direct display of gestation age, expected date of child delivery and direct measure of heart rate
- real-time clock displays date and time automatically
- display of body marks with corresponding probe position indication
- annotation function in image area of the screen. Special annotation terms for different exam-mode can be added according to user's requirement
- built-in rechargeable lithium Ion battery. Life up to 2.5 hours
- full touch screen display



Button free screen and waterproof front panel

Select your applications from visual icons



Take measure with your fingers, no trackball (accuracy 1 mm)

Adjustable angle stand converts into carrying handle

Refine the image with easy, touch driven TGC, focus and depth



GIMA code	PROBES	FREQUENCY (MHz)		● Main application						
	Scanning Method	Main freq.	Probe band width	ABDOMINAL OB/GYN	UROLOGY	CARDIOLOGY	VASCULAR	SMALL PARTS	MSK	PAEDIATRIC
33922	CONVEX	3.5	2.5 - 5.0	●	●	●				
33923	LINEAR	7.5	5.0 - 10.0				●	●	●	
33924	MICRO-CONVEX	3.0	2.5 - 5.0	●	●	●				
33926	TRANSVAGINAL	6.0	4.0 - 7.5			●	●			
33927	MICRO-CONVEX	6.0	4.0 - 8.0							●

# CHISON Q5, Q9 AND Q9 4D PORTABLE COLOURDOPPLER

• **33950 CHISON Q5 COLOURDOPPLER** with 2 probe connector, 15" high resolution monitor, 500 GB hardisk, 2 USB port, LAN port, Video, TV, VGA out, I-Image, without probe. Portable digital colourdoppler with high professional features:

**Imaging mode:**

- Instant Triplex, Duplex
- B, 2B, 4B, B/M, M
- CFM
- PW mode
- Power Doppler / Directional PD
- Trapezoidal
- Chroma B/PW

**Image processing technology:**

- Multi-beam former technology
- I-image™: image optimization technology
- THI
- Speckle reduction algorithm (SRA)
- Multiple compound imaging (MCI)

Operating voltage: 110-240 V, 50-60 Hz. Manual: GB, IT, on request FR.

• **33952 CHISON Q9 COLOURDOPPLER**

Same as Q5 but with TDI quantitative cardiac dialysis, THI on all probes, double phase digital beam, DPDBF, IMT calculation, needle enhancement, 500 GB hard disk, quadplex, Cardiac Package. Suitable for cardiac use.

**Cardiac Package** (ECG software, CW, Free Steering M, colour M, TDI) included.

• **33951 CHISON Q9+4D COLOURDOPPLER**

Same as Q9 but with 4D real time imaging.

• **33901 TROLLEY FOR Q5, Q8, Q9**



GIMA code for Q5	GIMA code for Q9	PROBES	FREQUENCY (MHz)		● Main application						
		Scanning Method	Main freq.	Probe band width	ABDOMINAL OB/GYN	UROLOGY	SMALL PARTS	ENDOCAVITY	CARDIOLOGY	PEDIATRICS	VESSELS
33954	33954	CONVEX	3.5	2.5 - 5.3	●	●	●				
33955	33955	LINEAR	7.5	5.0 - 12.0			●				●
33956	33956	TRANSVAGINAL (MICRO-CONVEX)	6.0	4.0 - 12.0			●	●			
-	33957	CARDIAC (PHASED ARRAY)	3.0	2.5 - 5.0					●		
33958	33958	PEDIATRIC	5.0	3.5 - 9.6						●	
33959	33959	4D CONVEX	4.0	2 - 6.8	●	●					



# GIMA VITAL SIGNS MONITORS

"Vital Signs" is a line of small multi-parameter patient monitors, which can monitor the vital physiological parameters: non-invasive blood pressure (NIBP), pulse oxygen saturation (SpO<sub>2</sub>), electrocardiogram (ECG) and temperature (TEMP).

Features:

- small size, clear and bright display (14x17 cm) for remote view
- up to 12,000 groups of NIBP measurements can be stored and listed
- up to 96 hours of SpO<sub>2</sub> and HR trend curve can be displayed
- built-in rechargeable battery, 2 hours use (35120-2) or 3 hours (35124)
- USB port (35124 only)
- optional built-in thermal printer

GIMA code	MONITOR	SpO <sub>2</sub>	NIBP	ECG	TEMP
35120	VITAL-S	•			
35121	VITAL-SNT	•	•		•
35122	VITAL-SNET	•		•	
35124	VITAL PRO-SNET	•	•	•	•
35125	Printer* - optional	* Installation done by Gima if ordered with monitor.			
35141	Paper 5.1 cm x 12 m - box of 5	Need service if ordered later.			
35126	Lead acid re-chargeable battery - spare for 35120-2				
35129	Lithium re-chargeable battery - spare for 35124				
35135	Adult SpO <sub>2</sub> probe - spare				
35136	Pediatric SpO <sub>2</sub> probe				
35137	ECG cable - spare				
35140	NIBP cuff - 10-19 cm - pediatric				
35142	NIBP cuff - 18-26 cm - pediatric XL				
35139	NIBP cuff - 21-35 cm - adult				
35143	NIBP cuff - 27-42 cm - adult XL				
35127	Trolley - adjustable 73 to 113 cm				
35128	Rail clamp				

STANDARD ACCESSORIES	35120	35121	35122	35124
- Adult SpO <sub>2</sub> probe	•			
- NIBP adult cuff		•	•	•
- Temperature probe - skin type		•	•	•
- ECG cable + 10 ECG electrodes		•	•	•
- Lead acid battery	•			
- Lithium battery				•
- Manual (English)	•	•	•	•



TECHNICAL SPECIFICATIONS	
<b>NIBP</b>	Pulse rate measurement accuracy: ± 2 bpm or 2% whichever is greater
Technology: Oscillometric method	Standard measurement range: Size: 18.5 x 18 x h 29 cm Weight: 2.4 kg
Standard measurement range:	Systolic: Adult: 50 - 240 mmHg
Systolic: Adult: 50 - 240 mmHg	Diastolic: Adult: 15 - 180 mmHg
Diastolic: Adult: 15 - 180 mmHg	MAP: Adult: 25 - 200 mmHg
MAP: Adult: 25 - 200 mmHg	Measurement mode: Manual, Auto, STAT
Measurement mode: Manual, Auto, STAT	<b>ECG and TEMP</b>
<b>SpO<sub>2</sub></b>	Heart rate range: 20 - 300 bpm
SpO <sub>2</sub> measurement range: 0 - 99%	TEMP measurement range: 25 - 45 °C
SpO <sub>2</sub> measurement accuracy: 75 - 99% ±2%	Accuracy: ±2 bpm or 1% whichever is greater (ECG) ±0.2 °C (TEMP)
50 - 74% ±3%	<b>Power</b>
Low perfusion performance: 0.4%	AC power supply: 100 - 250V, 50/60 Hz
Pulse rate measurement range: 30bpm~240bpm	Internal power supply: 12 VDC (rechargeable)
	Battery:
	12V 2,3AH (lead-acid battery) (35120-2)
	11.1 V, 4,400 mAh lithium battery (35124)

# PC-3000 MULTI-PARAMETER PATIENT MONITOR



- 35134 PC 3000 MULTI-PARAMETER PATIENT MONITOR
- 7" high resolution colour TFT display, 5-channel waveform display
- standard parameters: ECG, RESP, SpO<sub>2</sub>, NIBP, 2-TEMP, PR; Arrhythmia analysis and ST segment analysis
- up to 12,000 groups parameter data & 60-hour ECG waveform storage and recall
- 1,000-hour graphic and tabular trends for all parameters
- 7-channel ECG simultaneous waveforms display
- protection against interference from defibrillator, electrosurgical knife
- adult / pediatric measurement modes
- visual and audible alarms; networking capability
- carrying handle with bed-hooks

STANDARD ACCESSORIES		
1 ECG cable	1 NIBP cuff	10 Disposable electrodes
1 SpO <sub>2</sub> probe	1 Li-ion battery	1 Body surface temperature transducer
1 AC power Adapter	1 Power cable	User manual

GIMA code	ACCESSORIES - SPARES
35135	Adult SpO <sub>2</sub> probe - spare
35136	Pediatric SpO <sub>2</sub> probe
35137	ECG cable - spare
35138	Li-ion battery - spare
35140	NIBP cuff - arm circumf. 10-19 cm - pediatric
35142	NIBP cuff - arm circumf. 18-26 cm - pediatric XL
35139	NIBP cuff - arm circumf. 21-35 cm - adult - spare
35143	NIBP cuff - arm circumf. 27-42 cm - adult XL

TECHNICAL SPECIFICATIONS	
<b>NIBP Monitoring</b>	Automatic measurement by oscillating method
Measuring method:	Initial cuff inflation pressure: Adult mode: <180mmHg infant mode: <120mmHg
Initial cuff inflation pressure:	Overpressure protection limit: Adult mode: 300mmHg Infant mode: 240 mmHg
Overpressure protection limit:	<b>Measuring range</b>
<b>Measuring range</b>	Systolic pressure: Adult: 40-225 mmHg Infant: 40-200 mmHg
Systolic pressure:	Diastolic pressure: Adult: 20-215 mmHg Infant: 20-165 mmHg
Diastolic pressure:	Mean arterial pressure: Adult: 10-195 mmHg Infant: 10-150 mmHg
Mean arterial pressure:	Measurement accuracy: Systolic ±10% Diastolic ±10% MAP ±10%
Measurement accuracy:	Measurement mode: Manual, Auto, STAT
Measurement mode:	Automatic measuring: 1-240min
Automatic measuring:	<b>TEMP Monitoring</b>
<b>TEMP Monitoring</b>	Measuring range, accuracy: 25.0 - 45.0 °C, ±0.2°C
Measuring range, accuracy:	<b>SpO<sub>2</sub> &amp; Pulse Rate Monitoring</b>
<b>SpO<sub>2</sub> &amp; Pulse Rate Monitoring</b>	Transducer: dual-wave length LED
Transducer:	SpO <sub>2</sub> measuring range: 35%-100%
SpO <sub>2</sub> measuring range:	Low perfusion capability: 0.4%-5%
Low perfusion capability:	SpO <sub>2</sub> display accuracy: 70%-100% ±3%
SpO <sub>2</sub> display accuracy:	PR measuring range: 30bpm-250bpm
PR measuring range:	PR measuring accuracy: ±2bpm
PR measuring accuracy:	<b>ECG Monitoring</b>
<b>ECG Monitoring</b>	Heart rate measurement: ±0.4 mVp - ±5 mVp
Heart rate measurement:	Heart rate display range: 20 - 250bpm
Heart rate display range:	Display accuracy*: ±1% or ± 2 bpm, whichever is greater
Display accuracy*:	Heart rate alarm delay time: ≤10s
Heart rate alarm delay time:	Sensitivity selection: Auto, x1/2, x1, x2, x4 tolerance: ≤5%
Sensitivity selection:	Sweeping speed: 12.5 mm/s, 25 mm/s, 50 mm/s tolerance: ≤10%
Sweeping speed:	Common-mode rejection ratio: ≥89 dB
Common-mode rejection ratio:	Frequency response: Monitoring mode: 0.5 - 40 Hz
Frequency response:	Diagnostic mode: 0.05 - 75 Hz
<b>RESP Monitoring</b>	<b>RESP Monitoring</b>
<b>RESP Monitoring</b>	Monitoring range, accuracy: 0 - 120 rpm, ±5% or 2 rpm, whichever is greater
Monitoring range, accuracy:	RESP alarm range: 0 - 100 bpm ±10%
RESP alarm range:	<b>Other Technical Specifications</b>
<b>Other Technical Specifications</b>	Power supply: 100 - 250 Vac, 50/60 Hz <80 VA
Power supply:	Networking port: serial/Net port
Networking port:	



# UP 7000 MULTI-PARAMETER PATIENT MONITOR

ECG+RESP+SpO<sub>2</sub>+  
2 TEMP+PR



- 35145 MULTI-PARAMETER PATIENT MONITOR  
ECG, RESP, SpO<sub>2</sub>, 2 TEMP, PR
- 12.1" high resolution colour TFT display
- 3 channel ECG amplification
- arrhythmia analysis and ST segment analysis
- up to 800 groups parameter data & 24-hour ECG waveform storage and recall
- 480-hour graphic and tabular trends for all parameters
- 7 trace ECG waveforms simultaneous display
- protection against interference from defibrillator
- adult/pediatric measurement modes
- visual and audible alarms
- built-in rechargeable battery
- built-in thermal printer
- multilanguage internal software: GB, FR, IT, ES, PT, PL, CZ, TR, RU, CN



GIMA code	ACCESSORIES AND SPARES
35135	Adult SpO <sub>2</sub> probe
35136	Pediatric SpO <sub>2</sub> probe
35137	ECG cable
35140	NIBP cuff - arm circumf. 10-19 cm - pediatric
35142	NIBP cuff - arm circumf. 18-26 cm - pediatric XL
35139	NIBP cuff - arm circumf. 21-35 cm - adult
35143	NIBP cuff - arm circumf. 27-42 cm - adult XL
35126	Lead acid rechargeable battery - spare
35141	Paper 5.1 cm x 12 m - box of 5
35150	Trolley - adjustable 73 to 113 cm

STANDARD ACCESSORIES		
- Adult SpO <sub>2</sub> probe	- Re-chargable battery	- Disposable electrode
- NIBP adult cuff	- Printer	- Dust-protective mantle
- Temperature probe - skin	- Power supply cable	- Manual (GB, IT)
- Temperature probe - rectal	- ECG cable 5 leads (RA - LA - LL - PL - C)	

TECHNICAL SPECIFICATIONS			
<b>NIBP Monitoring</b>			
Measuring method:	Oscillometric		
Measuring range:	Systolic pressure:	Diastolic pressure:	Mean arterial pressure:
adult:	40-255mmHg	10-220mmHg	20-215mmHg
pediatric:	40-200mmHg	10-110mmHg	20-165mmHg
<b>TEMP Monitoring</b>			
Measuring range:	25.0°C-45.0°C ±0.2°C		
Response time:	≤ 150 sec		
<b>SpO<sub>2</sub> &amp; Pulse Rate Monitoring</b>			
SpO <sub>2</sub> measuring range:	35%~100%		
PR measuring range:	30bpm~240bpm ±2bpm		
<b>ECG Monitoring</b>			
Heart rate measurement:	±0.4mVp~±5mVp		
Heart rate display range:	20bpm~250bpm		
<b>RESP Monitoring</b>			
Measuring method:	Thoracic impedance		
Monitoring range:	0rpm~120rpm		
Monitoring accuracy:	±5% or ±2rpm whichever is greater		
<b>Other Technical Specifications</b>			
Power supply:	100~250Vac, 50/60Hz		
Power consumption:	<80 VA		
Display mode:	12.1 inches TFT color LCD		
Alarming mode:	Audible-visual alarm		
Networking port:	Ethernet port		
Size - weight:	29x31.5x15 cm - 3.9 kg		

# CMS 8000 CONTEC PATIENT MONITOR

ECG+RESP+SpO<sub>2</sub>+  
NIBP+2 TEMP+PR



Size: 314x145x264 mm  
Weight: 3.9 kg

- 35151 CMS 8000 PATIENT MONITOR  
ECG, RESP, SpO<sub>2</sub>, PR, NIBP, DUAL CHANNEL TEMP
- 12.1" TFT colour LCD display
- multilanguage interface (GB, IT, FR, DE, ES, PT, NL, PL, CZ, TR, RO, RU)
- adult/pediatric/neonate measurement modes
- 8 channel waveform synchronous display
- 7 lead ECG waveform on one screen
- anti-motion, anti-ambient light interference digital SpO<sub>2</sub> technology
- AC/DC rechargeable lithium battery
- manual/AUTO/continuous NIBP measurement mode
- standard/OXY- graph/Trend-graph/big characters and view bed interfaces

GIMA code	ACCESSORIES AND SPARES
35149	Adult SpO <sub>2</sub> probe - 3 m cable - spare
35107	Neonate SpO <sub>2</sub> probe <3 kg - reusable
35108	SpO <sub>2</sub> extension cable
35113	Pediatric NIBP cuff 18-26 cm
35114	Adult NIBP cuff 25-35 cm
35115	Adult large NIBP cuff 33-47 cm
35116	Thigh NIBP cuff 46-66 cm
35154	Rectal temp probe - optional
35155	Skin temp probe - spare
35156	ECG cable - spare
35157	Printer - optional
35158	Trolley
35159	Rechargeable lithium battery - spare
32968	Printer paper roll 50 mm x 20 m



Adjustable height  
104-130 cm

STANDARD ACCESSORIES	
- Adult SpO <sub>2</sub> probe	- ECG cable
- NIBP adult cuff	- power supply cable
- NIBP extension tube	- manual (GB, IT, ES) on request (PT, TR)
- Temperature probe - skin	- ECG electrodes
- Rechargeable lithium battery	

TECHNICAL SPECIFICATIONS	
<b>ECG</b>	Measurement period in CONT mode: 5 min
5-lead, dual channel, 3-lead, single channel	Measurement alarm: 10-270 mmHg
Scan speed: 12.5 mm/s, 50 mm/s	<b>SpO<sub>2</sub></b>
ST segment monitoring	Measurement and alarm range: 0-100%
Measurement and alarm range: -2.0 mV ±2.0 mV	Measurement accuracy: 70-100% ±2%
<b>RESP</b>	<b>PR</b>
Method: R-F (RA-LL) impedance	Measurement and alarm range: 30-250 bpm
Measurement and alarm range: 0-150 rpm	<b>TEMP</b>
Apnea alarm: 10-40 sec	Channel: dual channel
<b>NIBP</b>	Measurement and alarm range: 0-50 °C
Method: oscillometry	Power supply: 110-240 V - 50/60 Hz
Mode: manual/AUTO/continuous	Safety classification: Classe I type CF
Measurement interval in AUTO mode:	Defibrillation-proof applied part
1/2/3/4/5/10/15/30/60/90/120/240/480/960 min	

# BM7 PREMIUM PATIENT MONITOR FOR INTENSIVE CARE



• **33774 BM7 MONITOR 12.1"** touch screen LCD display - 7 channels Premium patient monitor for intensive care.

**Superior features:**

- touch screen operation display
- individual sweep speed setting for each parameter
- 168 full hours of trend data storage
- 4-split large multiple display modes
- oxy/CRG
- drug calculation
- screen freeze ON-OFF
- ST level analysis histogram

**High performances:**

- ECG, SpO<sub>2</sub>, NIBP, Respiration, 2 Temp, 2 IBP
- Sidestream EtCO<sub>2</sub> - optional
- 13 Arrhythmia analysis modes
- high performance **Suntech NIBP**
- Li-ion battery with longer life time (1.5 hrs continuous operation)
- possibility to connect to BM central monitoring system see page 291

• **33725 CART** - adjustable height, basket included

• **33709 Li-ion BATTERY 11.1 V** - spare

Same accessories and probes as BM5 monitors, see page 292, 293.

**STANDARD ACCESSORIES**

5-lead patient Cable (MECA5 (AHA), MACE5 (IEC))  
Electrodes - box of 10  
NIBP extension tube (3m)  
Reusable Adult Cuff (25-35 cm)

Reusable Pediatric Cuff  
SpO<sub>2</sub> extension cable (2m)  
Reusable Adult SpO<sub>2</sub> probe  
DC adapter (18 VDC, 2.5A)

Li-ion 11.1 V battery  
Thermal printer  
2 paper roll  
User manual: GB, IT

**TECHNICAL SPECIFICATIONS**

**MONITOR**  
**Display, Resolution** 12.1" color TFT. 800x600 pixels  
**Dimension** 322x250x224.8 mm  
**Weight** Approx. 4.5 kg  
**Trace** 6 waveforms: 2xECG, SpO<sub>2</sub>, RR or EtCO<sub>2</sub>, 2xIBP  
Sweep speed: 6.25, 12.5, 25, 50 mm/sec  
**Indicators** Categorized alarms (3 priority levels)  
Visual alarm lamp handle and heart beat tone  
QRS beep & SpO<sub>2</sub> pulse beep  
SpO<sub>2</sub> pitch tone  
Battery status, external Power LED  
**Interfaces** Touch screen, rotary knob  
**Connectors** DC input connector: 18 VDC, 2.5 A  
Defibrillator Sync. Output:  
- Signal level: 0 to 5 V pulse  
- Pulse width: 100 ± 10 ms  
LAN digital output for transferring data  
External VGA monitor connection  
DC output 5VDC, 1A Max  
**Battery** Rechargeable Li-ion battery,  
1.5 hours continuous operation  
**Thermal Printer** Speed: 25, 50 mm/sec,  
paper width: 58 mm  
**Data Storage** 168 hours trends, 20 cases of  
10 sec alarm waveform  
USB memory storage  
**Internal language (selectable)** GB, FR, IT, ES, DE,  
CZ, PL, PT, RO, BG, HU, TR, RU, CN, KR

**ECG**  
**Leads type** 3-lead, 5-lead  
**Lead selection** 3-lead: I, II, III  
5 lead: I, II, III, aVR, aVL, aVF, V  
3-lead: 1 channel  
5-lead: 2/7 channel  
**Heart rate range** Adult: 15-300 bpm  
Neonate/pediatric: 15-350 bpm  
**Heart rate accuracy** ±1 bpm or ±1% whichever is greater  
**Sweep speed** 6.25, 12.5, 25, 50 mm/sec  
**Filter** Diagnosis: 0.05~120 Hz  
Monitoring: 0.5~40 Hz  
Moderate: 0.5~25 Hz  
Maximum: 5~25 Hz  
**S-T segment detection range** -2.0 to 2.0 mV  
**Arrhythmia analysis** ASYSTOLE, VTACH, VFIB,  
BIGEMINY, ACCVENT, COUPLET,  
IRREGULAR, PAUSE, PVC, RONT,  
TRIGIMINY, VBRADY, SHORTRUN  
**Pacemaker detection mode**  
Indicator on waveform display (user selectable)  
**Protection** Against electrosurgical interference  
and defibrillation  
**RESPIRATION**  
**Method** Thoracic impedance  
**Channel selection** RA-LA or RA-LL  
**Measurement range** 5-120 breath per minute  
**Accuracy** ±1 breath per minute  
**Apnea alarm** Yes  
**SpO<sub>2</sub> range** 0 to 100%; (70 to 100% ±2% digits)

**Pulse rate range** 0 to 254 bpm ±2 bpm  
**NIBP SUNTECH**  
**Method** Oscillometry  
**Operation** Mode manual / Automatic / Continuous  
**Pressure measurement range** 0-300 mmHg  
**Safety pressure:** Adult: 300 mmHg  
Neonate: 150 mmHg  
Adult pressure: 20 to 220 mmHg  
**Measurement range:** Pulse rate: 30-220 bpm  
Pediatric pressure: 20-160 mmHg  
Pulse rate: 30-220 bpm  
Neonate pressure: 20-130 mmHg  
Pulse rate: 30-220 bpm  
**Accuracy:** The static pressure measurement is  
within ±3 mmHg  
Meets ANSI/AAMI SP 10 2002  
**TEMPERATURE**  
**Measurement range:** 10 to 45°C (59 to 113°F) ±0.1°C  
**Compatibility** YSI SERIES 400 temperature probes  
**IBP**  
**Channels** 2  
**Measurement range:** -50 to 300 mmHg  
**Accuracy** <100 mmHg ±1 mmHg  
>-100 mmHg ±1% of reading  
**Pulse rate measurement range** 0 to 300 bpm  
**Zero balancing** Range: ±200 mmHg  
Accuracy: ±1 mmHg  
Drift: ±1 mmHg of over 24 hours  
**Transducer sensitivity:** 5 µV/mmHg  
**Pulse rate measurement range:** 0 to 300 bpm

## BM1, BM3, BM5, BM7 MONITOR ACCESSORIES

GIMA code	ACCESSORIES FOR BM1, BM3, BM5, BM7	Image	Image	Image	
33738	<b>NIBP</b> Extension cable, 3 m (necessary for all cuffs) Adult cuff - 49x15 cm - need ext. cable 33738 Child cuff - 35x11 cm - need ext. cable 33738 Obese cuff 62x75.5 - need ext. cable 33738 Kit of 3 neonatal cuffs* - needs cable 33738 Mini cuff 16x5 cm - needs 33738+33739 Mini cuff 23x5 cm - needs 33738+33739 Metal connector (necessary for mini cuff)			33736	
33735					
32810					
32811					
33771		<b>Temp</b> Temperature sensor 3.0 m, skin type <i>Compatible with Drager MM15114, MM15822, GE 21733601, Philips HP21059B, Nihon Kohden P242A, Datascope 0206-02-0003</i>			
33772					
33772					
33743	<b>Paper</b> Thermal paper 57.5 mm, 38 Ø				
33742	<b>Battery</b> Ni-MH 12V battery - up to January 2006** - BM3, BM3 Plus Ni-MH 12V battery - Since January 2006** - BM3, BM3 Plus Li-ion battery - Since Sept. 2007** - new BM3, Plus, BM5 Li-ion battery 11.1 V - 6 cell for EtCO <sub>2</sub> - for 33782 only Li-ion battery 11.1 V for BM1 Li-ion battery 11.1 V for BM7				
33715					
33717					
33798					
33710					
33709					
33747	<b>Adapter</b> AC adapter for BM3, BM5, BM7				

\*\*Date is approximative. Please select battery according to picture and specifications

\* Cuff 3.3-5.6 cm, 4.2-7.1 cm, 5-10.5 cm

# COLOUR MULTIPARAMETER MONITORS



Pacemaker detection indicated on ECG display

- 33718 GIMA BM3 MONITOR (7" - 800x480 - TFT display)
- 33719 GIMA BM3 VET MONITOR - VETERINARY

## ECG+SpO<sub>2</sub>+NIBP+RESP+TEMPERATURE

- GIMA monitors are configured with
- 7" colour TFT LCD for a clear view
  - Individual sweep speed setting for each parameter
  - 128 full hours trend data stored
  - SpO<sub>2</sub> measurement with very low perfusion detection and pulse beep
  - 2 traces ECG
  - screen freeze on/off
  - connection to Central monitoring system using LAN or W-LAN
  - Li-ion Battery (for 1.5 hours continuous operation)
  - High-performance ECG detection and analysis
    - input impedance for dry skin or electrode patch
    - ST level, PVC count real-time display
    - 3 kinds of Arrhythmia analysis
  - Enhanced data management
    - graphical and tabular trends
    - 20 cases per 10 sec alarm waveform stored, reviewed and printed
  - Internal software selectable in GB, DE, FR, IT, PT, PL, RO, HU, ES, CZ, BG, RU, TR, CN
  - User manual: GB, IT (on request: ES, FR, DE).
- 33725 CART Adjustable height, basket included
- See temperature sensors, cuffs, batteries and accessories at page 290, 293



Angle of plate adjustable

Height of cart is adjustable



33725

Moving cart increase flexibility around the ward or department.

58 mm built-in printer for both real time and trend data (Speeds: 25-50 mm/sec)

Battery status indicator - continuous operating time 1.5 h

Printing sample

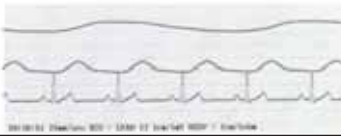

Easy mounting with bed-rail hook



Direct connection of external monitor through optional card

STANDARD ACCESSORIES	33718	33719
3 lead patient cable (ECG)	•	• vet
Disposable electrodes: 10 pcs	•	•
NIBP tubing - 3m	•	•
Reusable adult cuff 25-35 cm	•	•
Reusable child cuff	•	•
Set of 3 veterinary cuffs	•	•
SpO <sub>2</sub> sensor - reusable	•	• vet
SpO <sub>2</sub> sensor extension cable 2 m	•	•
Thermal printer 58 mm	•	•
DC adaptor (18 VDC, 2.5A)	•	•
Battery	•	•
User manual: GB, IT	•	•

Display modes



ST analysis display mode



Large parameter display mode

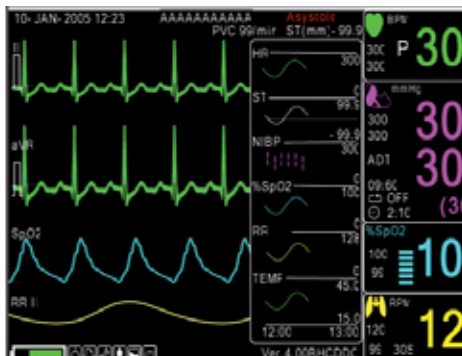

Trend display mode

## PATIENT CENTRAL SYSTEM (up to 31 monitors)

It allows the user to monitor and extract the exact status of several patients simultaneously at a place. Convenient bidirectional communication allows you to admit new patient information, set alarms at either central station or patient monitor.

- 33745 WIRE CENTRAL SYSTEM (PC, monitor, 16 port switch and software)
  - 33746 LAN CABLE - 3 m
  - 33767 LAN CABLE - 30 m
- One for any monitor to be connected.
- 33758 WIRELESS CENTRAL SYSTEM (PC, monitor, wireless router and software)
  - 33759 WIRELESS CONNECTION KIT (Ethernet converter and power cable)
- One for any monitor to be connected.

## TECHNICAL SPECIFICATIONS

GENERAL	
Display:	7" colour TFT 800x480 pixels
Dimensions - Weight:	238x250xh 163 mm - 3.1 kg
Trace	4 waveforms: 2*ECG, SpO <sub>2</sub> , Respiration
Indicators	Sweep speed: 6.25, 12.5, 25, 50 mm/sec Categorized alarms (3 priority levels) Visual alarm, QRS beep & SpO <sub>2</sub> Pulse beep Percent (%) SpO <sub>2</sub> pitch tone, Battery status, External Power LED
Thermal printer:	25, 50 mm/sec (paper width 58 mm)
Battery:	Rechargeable Li-ion battery Operating time: 1.5 hours (fully charged)
Interfaces:	LAN digital output for transferring data DC input connector: 18 VDC, 2.5 A max
Operating voltage:	100-240 V, 50-60 Hz
Data storage:	128 hours trends, 20 cases of 10 sec alarm waveform
ECG	
Lead type:	3-lead, 5-lead (option)
Lead selection:	3-lead I, II, III 5-lead I, II, III, aVR, aVL, aVF, V (option)
Heart rate range:	Adult: 30 to 300 bpm, Neonate/Pediatric: 30 to 350 bpm
Heart rate accuracy:	± 1bpm or ± 1%, whichever is greater
Sweep speed:	6.25, 12.5, 25, 50 mm/sec
Filter:	Diagnosis: 0.05 to 150 Hz - Monitoring: 0.5 to 40 Hz Moderate: 0.5 to 25 Hz - Maximum: 5 to 25 Hz
S-T segment detection range:	-2.0 to 2.0 mV

Arrhythmia analysis:	ASYSTOLE, VTACH, VFIB
Pacemaker detection mode:	Indicator on waveform display (user selectable) Against electro-surgical interference and defibrillation
Protection:	
SpO <sub>2</sub>	
% Saturation Range:	0% to 100% ± 2 digits (70% to 100%)
Pulse rate range:	30 to 254 bpm ± 2 bpm
NIBP	
Technique:	Oscillometric
Measurement Modes:	Manual/automatic/continuous
Pressure range:	0 to 300 mmHg ± 3 mmHg
Measurement range:	Adult pressure: 20 to 260 mmHg Pediatric pressure: 20 to 230 mmHg Neonatal pressure: 20 to 120 mmHg
Respirations	
Method:	Thoracic impedance
Range:	5 to 120 breath/min
Accuracy:	± 1 breath/min
Apnea alarm:	yes
Temperature Unit	
Range:	0° to 50°C (32°F to 122°F)
Accuracy:	± 0.1°C (25°C to 50°C), ± 0.2°C (0°C to 24°C)
Compatible with:	YSI Series 400 Temperature Probes



33745

# BM5 MULTIPARAMETER MONITOR WITH EXTENDIBLE PARAMETERS

- 33777 GIMA BM5 MONITOR - 10.4" TFT display - 7 ch ECG
  - 33779 GIMA BM5 VET MONITOR - 10.4" TFT display
  - high-performance ECG analysis
  - ST level PVC count display
  - 13 kinds of Arrhythmia analysis
  - 7 channels
  - 10.4" colour TFT screen with 6 waveforms
  - visible alarm lamp handle
  - SpO<sub>2</sub> technology with very low-perfusion detection
  - SpO<sub>2</sub> pitch tone
  - 58 mm built-in chart recorder
  - graphical and tabular trends of printing
  - LAN or wireless LAN
  - 128 full hours trend data stored
  - direct DC input for vehicle transport
  - Li-ion battery with long life time
  - connection to central monitoring system
  - selectable software language (GB, DE, FR, IT, PT, PL, RO, HU, ES, CZ, BG, RU, TR, CN).
- Standard accessories as BM3 monitor, page 291. Other accessories page 290-293.



ECG+SPO<sub>2</sub>+NIBP+RESP+ 2 TEMP, optional 2 IBP + ETCO<sub>2</sub> MODULE

12 Channel display

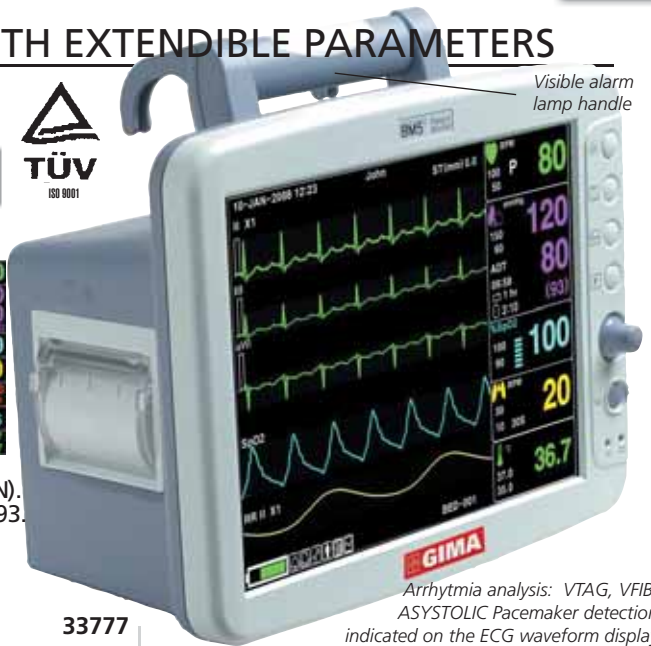

Visible alarm lamp handle

Arrhythmia analysis: VTAG, VFIB, ASYSTOLIC Pacemaker detection indicated on the ECG waveform display

GIMA code	TEMPERATURE, EtCO <sub>2</sub> AND IBP KIT
33771	Temperature sensor 2.75 m - skin type
33772	Temperature sensor 2.75 m - rectal
33741	Exacon temperature sensor 2.75 m - rectal
33796	EtCO <sub>2</sub> Sidestream module for 33714, 33777/8/9
33790	Intubated Filter Line H - adult - box of 10 for 33796
33791	Intubated Filter Line H - infant - box of 10 for 33796
33792	Non intubated CO <sub>2</sub> nasal cannula - adult - box of 10 for 33796
33793	Non intubated CO <sub>2</sub> nasal cannula - pediatric - box of 10 for 33796
33794	Non intubated CO <sub>2</sub> +O <sub>2</sub> nasal cannula - adult - box of 10 for 33796
33795	Non intubated CO <sub>2</sub> +O <sub>2</sub> nasal cannula - pediatric - box of 10 for 33796
33786	Single line monitoring kit (catheter)
33787	IBP Kit - disposable - single
33788	IBP Kit - reusable (not autoclavable) - single
33789	IBP Kit - reusable (not autoclavable) - double

<p><b>33777</b></p> <p><b>33790</b> Airway adapter set with dehumidification tubing for intubated adult Suitable also for VET (dog, horse)</p>	<p><b>33792</b></p> <p><b>33794</b></p>
<p><b>33791</b></p> <p><b>33791</b> Airway adapter set with dehumidification tubing for intubated infants Suitable also for VET (cat, puppy)</p>	<p><b>33793</b></p> <p><b>33795</b></p>

### TECHNICAL SPECIFICATIONS FOR MONITOR 33777 - 33779

GENERAL	Heart rate range:	Adult: 30-300 bpm	Respirations
Dimensions/Weight: 270x185xh 250 mm/4 kg	Heart rate accuracy:	Neonate/pediatric: 30-350 bpm	Range: 5 to 120 breaths/min
Trace: 6 waveform (ECGx2, SpO <sub>2</sub> , RR or EtCO <sub>2</sub> IBPx2)	Sweep speed:	± 1 bpm or ± 1%, whichever is greater	Accuracy: ±1 breath/min
Indicators: categorized alarms (3 priority levels), visual alarm lamp handle, heart rate, SpO <sub>2</sub> pulse pitch tone, battery status, external power LED	Filter:	6.25, 12.5, 25, 50 mm/sec.	Apnea alarm: yes
Thermal printer: 25, 50 mm/sec (paper width 58 mm)	S-T Segment detection range:	Diagnostic mode: 0,67-150 Hz	Temperature Unit
Battery: Li-ion (2 hours operating time)	Arrhythmia analysis:	Monitoring mode: 0,67-40 Hz	Range: 15° to 45°C (59°F to 113°F)
Interfaces: LAN digital output for transferring data, Nurse call system connection, defibrillator sync. output	Diagnostic analysis:	Surgical mode: 5-25 Hz	Accuracy: ± 0.1°C
DC input connector: 12 to 18 VDC, 2.5A max	Pacemaker detection mode:	- 2.0 to 2.0 mV	Compatible with: YSI Series 400 Temperature Probes
Operating voltage: 100-240 V, 50-60 Hz	Protection: against electro-surgical interference and defibrillation		IBP - option
SpO <sub>2</sub>	NIBP		Channels: 2
% Saturation Range: 0% to 100%	Technique: Oscillometric with linear deflation		Measuring range: -50 to 300 mmHg
Pulse Rate Range: 0 to 254 bpm	Measurement Modes: Manual-Automatic-Continuous		Measuring accuracy: ± 1 mmHg (<100 mmHg)
SpO <sub>2</sub> Accuracy: 70% to 100% ±2 digits	Measurement range: Adult pressure: 20 to 260 mmHg		Measuring accuracy: ± 1 % of reading (>100 mmHg)
Pulse Rate Accuracy: ± 2 bpm	Pediatric pressure: 20 to 230 mmHg		Pulse rate counting range: 0 to 300 beats/min
ECG	Neonate pressure: 20 to 120 mmHg		Zero balancing: accuracy ± 1 mmHg drift ± 1 mmHg over 24 hours
Lead type: 3-lead, 5-lead (33777), 10-lead(33779)	Cuff pressure display: 0 to 300 mmHg		Transducer sensitivity: 5µV/V mmHg
Lead selection: 3-lead: I, II, III (33777/79)	B.P. measurement range: Systolic: 40 to 270 mmHg		EtCO <sub>2</sub> - option
10-lead: I, II, III aVR, aVL, aVF, V1, V2, V3, V4, V5, V6 (33779 only)	Mean: 20 to 230 mmHg		Measurement mode: Sidestream
ECG Waveforms: 3-lead 1 channel (33777/79)	Diastolic: 10 to 210 mmHg		Measurement range: 0~150 mmHg, 0 to 19%
5-lead: 3/7 channels (33777/79)	Adjustable Cuff Inflation Pressure		Respiration range: 2~150 bpm
10-lead: 3/12 channels (33779 only)			Accuracy: ± 2 mmHg, 0~40 mmHg
			Respiration accuracy: ± 5%, 41~70 mmHg
			Accuracy: ± 8%, 71~100 mmHg
			± 10%, 101~150 mmHg
			Respiration accuracy: ± 1 breath per minute

# BM1: SLIM AND LIGHT MONITOR WITH STRONG MOBILITY

- 33714 GIMA BM1 MONITOR SpO<sub>2</sub>+NIBP optional Temp. and EtCO<sub>2</sub>
  - Professional multiparameter monitor in compact size:
  - only 60 mm (2.36 inch) thick and 1.0 kg (2.2 lb)
  - easy mounting to an IV pole
  - 4.5 hours battery operation (rechargeable Li-ion)
  - top handle and rear grip
  - monitoring mode and spot check mode
  - 4.3" color TFT monitor for clear view 480x272 pixels
  - touch key and wheel navigation
  - external VGA output for large LCD monitor (option)
  - saves 128 hours trend and 400 cases
  - multilanguage selectable software (GB, FR, IT, ES, DE, PL, PT, RO, BG, HU, CZ, RU, TR, CN, KR)
  - highly advanced CO<sub>2</sub> monitoring technology
  - plug and play EtCO<sub>2</sub> module
- Same accessories of BM line. SpO<sub>2</sub>, TEMP, EtCO<sub>2</sub>, NIBP technical specifications same as BM5.
- 33710 Li-Ion RECHARGEABLE BATTERY - spare

SpO<sub>2</sub> + NIBP optional TEMP and EtCO<sub>2</sub>





Supplied with NIBP adult cuff (25-35 cm) with 3 m extension hose, SpO<sub>2</sub> adult finger probe with extension cable (2 m) DC adapter (15 VDC, 2.0 A) pole mount bracket, shoulder strap, rechargeable battery.





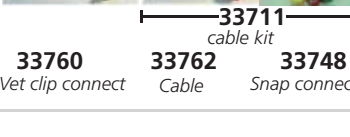
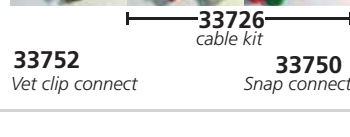

Size: 190x125x60 mm Weight: 1 kg



# ECG CABLES FOR BM GIMA AND BIONET MONITORS

GIMA code	ECG CABLES FOR BM3 (33718, 33719, 33720, 33721, 33722, 33723, 33724, 33780, 33781)	ACCESSORIES FOR MONITOR BM3, BM5, BM7					
		NEW (after 6/2006)	OLD (before 6/2006)				
33711	3-lead patient cable kit (cable+snap connectors 33748)	 33713 Vet cable kit	 33727 Vet cable kit				
33712	5-lead patient cable kit (cable+snap connectors 33749)						
33726	3-lead patient cable kit (cable+snap connectors 33750)						
33728	5-lead patient cable kit (cable+snap connectors 33751)						
33727	3-lead veterinary cable kit (cable+3 clips connectors)						
33713	3-lead veterinary cable kit (cable+3 clips connectors)	 33711 cable kit	 33726 cable kit				
33748	3-lead snap connectors for 33711 - spare - new						
33749	5-lead snap connectors for 33712 - spare - new						
33750	3-lead snap type connectors for 33726 - spare - old						
33751	5-lead snap type connectors for 33728 - spare - old						
33752	Vet 3-lead clip type connectors for 33726-7 - spare - old	 33712 cable kit	 33728 cable kit				
33753	Vet 5-lead clip type connectors for 33728 - spare - old						
33760	Vet 3-lead clip type connectors for 33713 - spare - new						
33761	Vet 5-lead clip type connectors for 33712 - spare - new						
33762	3-lead patient cable						
33763	5-lead patient cable	<b>ECG CABLES FOR BM5-BM7 (33777, 33778, 33779)</b>					
33764	3-lead patient cable kit (cable + snap connector)	33760 Vet clip connect	33762 Cable	33748 Snap connect	33752 Vet clip connect	33750 Snap connect.	
33765	10-lead patient cable kit (cable + snap connector) only 33778	33761 Vet clip connect	33763 Cable	33749 Snap connect	33753 Vet clip connect	33751 Snap connector	
33766	3-lead veterinary cable kit (cable + clip connector)						

# BM1, BM3, BM5, BM7 SpO<sub>2</sub> SENSORS - NELLCOR COMPATIBLE

GIMA code	SpO <sub>2</sub> SENSORS FOR ALL BM MONITORS	SpO <sub>2</sub> REUSABLE PROBES		
33730**	Adult reusable finger sensor (> 45 kg) Nellcor comp. - 7 pin	 7 pin	 33730 33731	
33731	Pediatric reusable finger sensor (15-45 kg) - Nellcor comp.			
33732	Vet reusable sensor - clip <i>**Not compatible with Nellcor NPB40 and N65</i>			33732
<b>AVAILABLE OTHER NELLCOR AND NELLCOR OXITECH REUSABLE COMPATIBLE SpO<sub>2</sub> SENSORS - see page 295</b>		<b>SpO<sub>2</sub> EXTENSION CABLES</b>		
GIMA code	EXTENSION CABLES FOR BM SpO <sub>2</sub> SENSORS	 33733 for units sold before Oct. 2005	 33716	
33733	Extension cable*, 2 m (7 pin small SpO <sub>2</sub> connector) up to 2005			 33734
33734	Extension cable*, 2 m (6 pin SpO <sub>2</sub> connector) sold in 2005/6/7			
33716	Extension cable*, 2 m (7 pin big SpO <sub>2</sub> connector) since 2007 <i>*Necessary for all probes. Please select correct one</i>			

# NELLCOR COMPATIBLE DISPOSABLE SpO<sub>2</sub> SENSOR

All probes are supplied in sterile pack with 70 cm cable.



GIMA code	NELLCOR COMPATIBLE DISPOSABLE SpO <sub>2</sub> PROBES (not compatible with Nellcor Oximax)
33755	Disposable neonate/adult probe - under 3 kg (neonate foot) - over 40 kg (adult finger)
33756	Disposable infant probe - 3-20 kg
33757	Disposable pediatric probe - 10-50 kg
33754	Disposable adult probe - over 30 kg

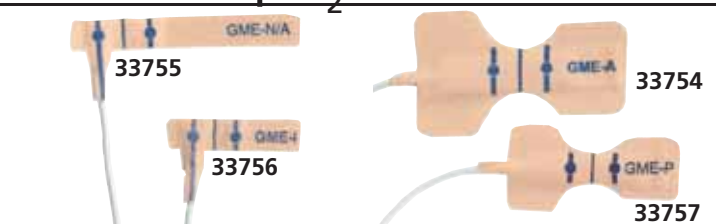

TECHNICAL SPECIFICATION SpO <sub>2</sub> SENSORS	
Range of SpO <sub>2</sub> measurement:	70%~100%
Accuracy:	70%~100% ±2%; below 70%: unspecified
Range of pulse measurement:	30~250 bpm
Accuracy:	±2 bpm of 2% (select larger)
Optical Sensor:	red light (wavelength is 650~670 nm, 6.65 mW) infrared (wavelength is 880~910 nm, 6.75 mW)

# WRIST OXIMETER

## • 34340 WRIST PULSE OXIMETER - with software

Small and lightweight wrist Oximeter available for home and clinical long-term and comfortable monitoring. It can be simply worn on the patient's wrist as a watch to start the monitoring and can be used during sports to measure SpO<sub>2</sub> and pulse rate (PR).

- audible and visual alarm with adjustable alarm limits
- trend review function of SpO<sub>2</sub> and PR
- selectable storage modes: 1 group/1s, 1 group/4s, and 1 group/8s
- up to 500 hours storage for SpO<sub>2</sub> and PR data in default mode (1 group/8s)
- clock setting and date display function
- software to download and store all measurements on PC integrated
- removable finger probe
- not suitable for pediatric use

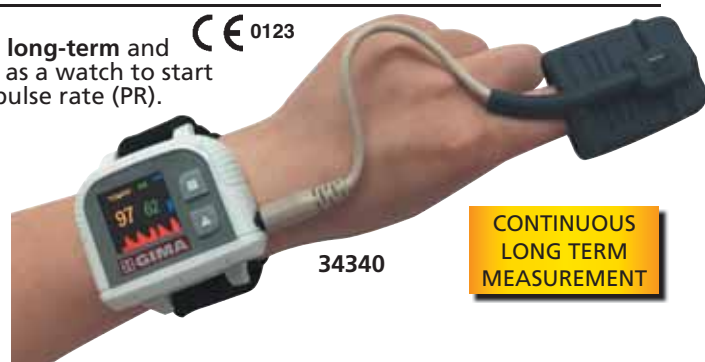

**CONTINUOUS LONG TERM MEASUREMENT**

# PC-300 SPOT CHECK BLUETOOTH MONITOR

**Standard:**  
SpO<sub>2</sub>, PR, NIBP,  
TEMP

**Optional ECG,  
GLUCOMETER**

35162



FDA 510 (K)  
CE 0476

Bluetooth 2.0  
and 4.0 standard





Memory of  
6,000 NIBP measures

- **35162 PC-300 SPOT CHECK MONITOR**
- PC-300 handheld Spot-check monitor measures SpO<sub>2</sub>, Pulse Rate, NIBP and TEMP. Widely used in hospitals, clinics and family daily measurement. Equipped with Bluetooth and USB interface, allows to transfer data to PC, tablets and smartphone (Android and iOS).
- up to 6000 groups NIBP data storage, up to 100 different patients (each user can store 999 measurement records)
- quick ear probe TEMP measurement result in 5 seconds
- data transfer to PC/Smartphone by USB or Bluetooth
- optional NIBP pediatric cuff and SpO<sub>2</sub> pediatric probe
- optional ECG and Glucometer
- built-in rechargeable lithium battery
- communication protocols available on request

**STANDARD ACCESSORIES**

- SpO<sub>2</sub> adult probe
- NIBP adult cuff
- Ear thermometer (probe covers not included)
- Lithium battery with charger
- Carrying bag
- User manual: GB, FR, IT, ES



GIMA code	PC-300 ACCESSORIES	
35164	SpO <sub>2</sub> pediatric probe - optional	
35165	SpO <sub>2</sub> adult probe - spare	 35165
35166	NIBP pediatric cuff 10-19 cm - with extension cable - optional	
35167	NIBP adult cuff 22-30 cm - spare	 35167
35170	Ear infrared thermometer	
35171	Ear probe cover - box of 500	 35170
35172	Lithium battery - spare	
PC-300 ACCESSORIES: glucose and ECG (optional)		
23890	Glucose monitor On Call Plus II* - IT, GR	 23890
23891	Glucose monitor On Call Plus II* - GB, FR	
23892	Glucose monitor On Call Plus II* - ES, PT	
23895	Glucose monitor Kit On Call Plus II* - IT, GR	
23896	Glucose monitor Kit On Call Plus II* - GB, FR	
23897	Glucose monitor Kit On Call Plus II* - ES, PT	
23910	Glucose strips - box of 25	
23912	Glucose strips - box of 50	
23913	Glucose strips - box of 100	
35176	Glucose monitor USB cable	
35178	ECG module** needs 33248	 35178
33248	ECG pin lead cable 3 leads	

**TECHNICAL SPECIFICATIONS**

- SpO<sub>2</sub>**
- Measuring range: 35%-100%
- Accuracy: ±3% (70-100%)
- Pulse Rate**
- Measuring range: 30-240 bpm
- Accuracy\*: ±2% or ±2 bpm (whichever is greater)
- \*Root-mean-square value of deviation according to ISO 1919
- NIBP**
- Pressure range: 0-300 mmHg (0-39.9kpa)
- Accuracy: ±3 mmHg
- Measuring range: Systolic pressure: 60-240 mmHg  
Diastolic pressure: 30-180 mmHg
- TEMP**
- Measuring range: 32-43.0°C
- Accuracy: ±0.2°C (35-42°C) - ±0.3°C (other)
- Measuring time: <5 s
- ECG (Optional)**
- Heart Rate measuring range: 30-240 bpm
- Heart Rate accuracy: ±2 bpm or ±2% whichever is greater
- Display scale: 5.0 mm/mV ±10%
- Common-mode rejection ratio (CMRR): ≥60 dB
- Blood Glucose (Optional)**
- Measuring range: 20 to 600 mg/DL
- SEE other specification at page 5
- Power Supply**
- Battery: 3.7 V built-in Li-ion battery
- Operating voltage: 3.6-4.2 VDC
- Operating current: ≤800 mA
- Charger: 100 - 240 VAC, 50/60 Hz, 5 VDC or USB

See glucose monitor accessories at page 5  
\*Needs USB cable 35176 to connect to PC-300 \*\*ECG module can be used without 3 leads cable in palm mode  
See electrodes at page 277-278

# PALM SAT® 2500A NONIN PULSE OXIMETER

• **35086 PALM SAT® 2500A PULSE OXIMETER with rubber reusable adult probe and alarm.**

A compact versatile and reliable pulse oximeter designed and tested to exceed all durability requirements.

Main features:

- Pure Sat® technology offers accuracy & speed in getting a reading, even with varying skin pigmentations or polish and is able to monitor, with declared accuracy in challenging conditions, such as motion & low perfusion, for all patients
- it is tested to assure performance in challenging conditions, such as drop and liquid ingress (IPX 2). Granted by US Army/Air Force Aeromedical certification
- It also features: audible and visual alarms, 72 hour memory, long battery life (60 hours) or rechargeable battery for 40 hours
- Supplied with multilanguage cd-rom manual: GB, FR, IT, DE, ES, PT, GR, NL, PL, NO, FI, DK, SE.

**TECHNICAL SPECIFICATIONS**

- SpO<sub>2</sub> range: 0% to 100% ±2 (70-100% without movement)
- Pulse rate range: 18 to 321 bpm ±3 (18-300% without movement)
- Power: 4AA alkaline batteries 1.5 V (for 60 hours use)  
optional NiMH rechargeable battery (for 40 hours use)
- Size: 7x13.8x3.2 cm Weight: 213 g

GIMA code	ACCESSORIES SAT 2500
35087	Adult reusable rubber probe (12.5-25.5 mm) - 1 m cable
35088	Pediatric reusable rubber probe (10-19 mm) - 1 m cable
35089	Charger stand with NiMH battery pack, plug kit
35082	NVISION software for data management (GB)
35083	Adaptor for USB - PC connection



Bright LED display of SpO<sub>2</sub> and pulse rate

Audible and visible alarms

**NONIN**

Made in USA

Easy 2 button operation

Three-coloured signal quality indicator

CE 0123  
FDA

Blinking alarm silence indicator  
Low battery indicator

Rugged rubberized case with IPX 2 level of liquid ingress protection

35086

35086 + 35089

# REUSABLE COMPATIBLE SpO<sub>2</sub> SENSORS FOR ALL BRANDS



1- Adult finger sensor		2- Adult soft-finger sensor		3- Adult Y-type ear sensor		4- Adult-neonatal wrap sensor		5- Pediatric sensor		6- Neonatal Y-type sensor	
GIMA code	OEM - Brand	N	Sensor type	Cable length	Connector type	Compatibility				Extension cable - 2.4 m	
35220*	BCI	5	Pediatric finger	0.9 m		BCI: 3401, 3304, 3303, 3302, 3301, 3300; Spacelabs Burdick: PRO <sub>2</sub> ; Draeger: Oxipac 2000/2500				35300	
35221		1	Adult finger	0.9 m						-	
35222		1	Adult finger	3.0 m						-	
35225	CSI (Criticare)	6	Neonatal Y-type	3.0 m		Alaris (IVAC): VitalCheck 4400; Criticare: 503DX, 503 Spot, 504DX/P, 504DX, 506 series (except 506LN3), 507ELC2, 8100 Poet Plus, Poet (602-3A), Scholar, Scholar III				-	
35226		1	Adult finger	0.9 m						-	
35227		1	Adult finger	3.0 m						-	
35230*	Datascope	1	Adult finger	0.9 m		Accusat, Accutorr 3/4 SAT, Accutorr Plus, Passport (Database SpO <sub>2</sub> )				35301	
35231		1	Adult finger	3.0 m						-	
35232*	Datex-Ohmeda	1	Adult finger	0.9 m		Datex-Ohmeda: AS/3, CS/3, CH/S, CH/2S, CH-RS, SAF-F, CG/2S, Cardiocap I, Cardiocap II, Cardiocap 5, Capnomac Ultima, Light Monitor, M-Estpr, Oscar II, OSP-200, Satellite Trans, Satllile, Trans Plus, System 5, ULTS00				35302	
35233		5	Pediatric finger	3.0 m						-	
35234		1	Adult finger	3.0 m						-	
35235		3	Adult Y-type ear sensor	3.0 m						-	
35238	GE Datex-Ohmeda	1	Adult finger	3.0 m		GE (Datex-Ohmeda): S/5, 14 Modular Monitors with Eseries modules, Corometrics® 259 with TruSignal Ohmeda Technology				-	
35239		2	Adult finger	4.0 m						-	
35240		3	Adult soft-finger	3.0 m						-	
35241		1	Adult Y-type ear	3.0 m						-	
35243		1	Adult finger	3.0 m		Ohmeda TruSat Ohmeda TruSat TD				-	
35245	GE	1	Adult finger	3.0 m		GE: Dash 2000/3000/4000 with Nellcor option, Dash 3000/4000/5000 with Ohmeda option, Solar 8000/8000M, i/9500 with Tram Module 451/451N/851/851N, CardioLab®/Mac-Lab® with Tram Module 451/451N Corometrics® 120/2120 series, Eagle 1000/3000/4000 Responder 3000 with Nellcor option				-	
35247*	GE TruSignal	1	Adult finger	0.9 m		TruSignal sensors and interconnect cables are backwards compatible with Datex, ohmeda and GE SpO <sub>2</sub> technologies.				35303	
35250	Goldway	1	Adult finger	3.0 m		Goldway: UT4000 A / 4000 A pro / 4000B, UT6000 C				-	
35252	Mindray	1	Adult finger	3.0 m		PM-600, PM-5000, PM-6000, PM-7000, PM-8000, PM-9000, MEC-1000 (Nellcor based) PM-50				-	
35255**	Nellcor	6	Neonatal Y-type	0.9 m		Artema: Diascope, Datascope: (Mindray): Accutorr Plus, Expert, Passport, PM-50; Drager: Cicero, Narkomed, Vitalert 1000, GE Medical: Corometrics 118, 120, 129, 188, 510, 556, Critikon 9710, 9720, Plus, Compact, Dinamap Select, MPS, Oxysuttle, Pro 300/400, Eagle Series, Dash Series, Hellige Eagle, 1000, 3000, Eagle SMK, SMU, SMV, SOLAR Series, TRAM Modular x50SL Series; Invivo Research: MI2 (Nellcor SpO <sub>2</sub> ), Millennia 4500 Plus 2, Invivo/MDE Escort 100 OPT11A Escort 300A, Escort II OPT30, Prism (Nellcor SpO <sub>2</sub> ); Ivy Biomedical: 405A, 4050, 405P, 405T, Vital-Guard 450 CN, Mennen: Horizon XL (Nellcor SpO <sub>2</sub> ), MR 1300 Mercury 1200; Nellcor: N100 (req. preamp cable), N180, N200 (req. preamp cable), N-20, NPB-75, NPB-290, NPB-295, N-390, N-395, N-3000, N6000; Nihon Kohden: BSM-1102 Life Scope EC, BSM2304 iPro (Life Scope i), BSM-4102, 4112 Procyon LT (Life Scope P), BSM-4104, 4114 Procyon (Life Scope P), BSM-9510 Life Scope M (Nellcor SpO <sub>2</sub> ), OGS2000 PocketCare (Nellcor SpO <sub>2</sub> ); Pace Tech Vitalmax 800 Series (cara negra Nellcor SpO <sub>2</sub> ): Philips 78352C, 78354C, 78834C, M1020A, M1025B, M1205A, M1350B, M1 722A/B, M1732A/B, M2475B, M2601A, M3000A				35304	
35256**		5	Pediatric finger	0.9 m						35304	
35257**		4	Adult/neonatal wrap	0.9 m						35304	
35258**		1	Adult finger	0.9 m						35304	
35259**		1	Adult finger	3.0 m						35304	
35260**		2	Adult soft-finger	0.9 m						35304	
35261**	3	Adult Y-type ear	3.0 m	35304							
35262**	Nellcor Oxitech	1	Adult finger	0.9 m		Nellcor Oximax: N-550, N-560, N-595, N-600 and Patient monitors with Oximax module				35305	
35263**		2	Adult soft finger	0.9 m						-	
35265**		4	Adult/neonatal wrap	0.9 m						-	
35264	Nihon-Kohden	1	Adult finger	3.0 m		Nihon Kohden: BSM-4101, 4103 4111, 4113 Life scope P BSM-5105, 5135 Life scope A BSM-2351, 2353 Life scope L BSM-2301, 2303 Life scope I, Life scope S				-	
35266**	Nonin	1	Adult finger	0.9 m		NONIN: 8500, 8600, 8700, 8800/9840 NONIN: 2500, 9600, 9700				-	
35268	Novamatrix	6	Neonatal Y-type	3.0 m		Novamatrix: 505, 510, 511, 515B/C, 520, 7000, 7100; Oxyleth				-	
35269		1	Adult finger	3.0 m						-	
35272	Ohmeda	1	Adult finger	3.0 m		Datex-Ohmeda: 3740, 3710, 4700 OxiCap, 520RGM, Biox 3760, Ohmeda 3700, 3770, 3775, Rascal II, GE Medical System: 7000 series, Corometrics 511, TRAM A.R., Tram Modular x00SL Series, Mennen: Horizon XL800 (Ohmeda SpO <sub>2</sub> )				-	
35275	Philips	6	Neonatal Y-type	1.6 m		Philips: M3, M4, MP20, MP30, MP40, MP50, MP70, MP80, VM4, VM6, VM8				-	
35276		4	Adult/neonatal wrap	1.6 m						-	
35277		1	Adult finger	1.6 m						-	
35278		1	Adult finger	3.0 m						-	
35279		2	Adult soft-finger	1.6 m						-	
35280		2	Adult soft-finger	3.0 m						-	
35281	3	Adult Y-type ear	3.0 m	-							
35283		2	Adult soft-finger	3.0 m		Philips: 1205, M1205A, 78352C, 78834C, 78354C, M1020A, M1025A, M1025B, M1350B, M1772A/B, M1732A/B, M2475B				-	
35285	Siemens/Drager	1	Adult finger	1.6 m		Siemens/Drager: SC6002XL, 7000, SC8000, SC9000XL				-	
35286		2	Adult soft-finger	1.6 m						-	
35287		3	Adult Y-type ear	1.6 m						-	

\*These SpO<sub>2</sub> sensors need extension cable for connection to device.

\*\* Available extension cable.

All products are supplied with manual in GB, FR, IT, ES.

# CAPNOGRAPH AND OXIMETER

**• 33698 CAPNOGRAPH AND OXIMETER PC-900B**  
 This innovative and handheld capnograph and oximeter is ideal for monitoring the most severe conditions of patients. It provides reliable SpO<sub>2</sub> and pulse rate measurements thanks to its unique MoveOxy™ technology specially conceived for SpO<sub>2</sub>. It offers an accurate monitoring even in weak pulse signals condition and reliable monitoring in movement. Display of graphical trends and plethysmographic waveform.

- 3.5" TFT display showing EtCO<sub>2</sub>, RR and SpO<sub>2</sub>, PR
- lung pressure and temperature compensation (BTPS compensation)
- for intubated or non-intubated patients
- graphic trend storage up to 24 hours
- USB cable to transfer data on PC
- wireless module to connect to Bluetooth printer

- Internal languages: GB, IT, ES, NL
- Water filter, sampling line and airway adapter must be changed anytime you use it.
- 34351 ADULT SpO<sub>2</sub> RUBBER PROBE - reusable**
- 34345 ADULT SpO<sub>2</sub> CLIP PROBE - reusable - spare**
- 34347 PEDIATRIC SpO<sub>2</sub> PROBE - reusable**
- 34349 NEONATAL SpO<sub>2</sub> Y PROBE - reusable**
- 33699 WATER FILTER**
- 33700 SAMPLING LINE**
- 33701 AIRWAY ADAPTER**
- 34172 NASAL CANNULAS**

TECHNICAL SPECIFICATIONS	
<b>EtCO<sub>2</sub></b>	
EtCO <sub>2</sub> /CO <sub>2</sub> range:	0-150 mmHg (0-20 kPa, or 0-20% (V/V))
Accuracy:	±2 mmHg when 0-40 mmHg ±5% (reading) when > 41-70 mmHg ±8% (reading) when > 71-100 mmHg ±10% (reading) when > 101-150 mmHg
Update:	Every breath, 10, 20 or 30 sec selectable
Trend length:	24 hours
<b>Respiration rate</b>	
Range:	3-150 breaths/min
Accuracy:	±1% (reading) or ±1 times/min whichever is greater
Trend length:	24 hours
Flux:	50-250 cc/min selectable

# OXY-200 DESKTOP PULSE OXIMETER

Continuous working time: more than 1 hour  
 Audible and visible alarm for over-limit and low battery.  
 Upper and lower alarm limit can be set.



**35101**  
 Screen brightness, volume and display mode can be adjusted  
 320x240 TFT screen and LCD  
 Menu operation easy to use

**• 35101 OXY-200 DESKTOP PULSE OXIMETER with monitor and battery**  
 Portable oximeter displays SpO<sub>2</sub>, PR, bar graph, PI, pulse waveform and battery power. Multiuser data storage and review. Stored data can be uploaded to PC in real time. Finger adult probe, battery and software for PC download are included.

- 35102 LITHIUM RECHARGEABLE BATTERY - spare**
- 35105 SpO<sub>2</sub> FINGER-PROBE - adult or child over 15 kg - spare**
- 35106 PEDIATRIC PROBE 3-15 kg - reusable**
- 35107 NEONATAL PROBE <3 kg - reusable - needs 35108**
- 35109 ADULT NEONATAL PROBE\* - disposable - needs 35108**
- 35108 EXTENSION CABLE necessary for 35107, 35109**

TECHNICAL SPECIFICATIONS	
Power supply:	100-240 V, 50/60 Hz rechargeable lithium battery
SpO <sub>2</sub> measuring range:	0-100% ±2% (between 70-100%)
Pulse rate:	30-250 bpm ±2 bpm or ±2% (select larger)
PI measuring range:	0-20% ±1% (between 1%-20%)
Size:	269x222x79 mm - Weight: 1 kg
Resolution:	1% (SpO <sub>2</sub> ), 1 bpm (Pulse rate), 0.1% (PI)
	User manual (GB, IT)

\*Suitable for adult over 40 kg (finger) or neonate less than 3 kg (foot)

CE 0123

FDA 510(K)



PC software for data review and analysis  
 Software (GB only) can be freely downloaded



Wireless connection  
 Bluetooth printer



STANDARD ACCESSORIES		
2 water filters	USB data cable	Support base
2 sampling lines	Nasal CO <sub>2</sub> sampling cannula	Manual GB, IT
2 airway adaptors	Silicone protective case	
SpO <sub>2</sub> probe	Carrying bag	



**34345**  
 Reusable SpO<sub>2</sub> adult probe



**34351**  
 Reusable SpO<sub>2</sub> adult rubber probe



**34347**  
 Reusable pediatric SpO<sub>2</sub> probe

# ETCO<sub>2</sub> + SPO<sub>2</sub>

Size: 170x88x44 mm  
**PORTABLE OXI-CAPNOGRAPHY MONITOR**

**• 33702 OXY CAPNOGR. HUMAN**  
**• 33703 OXY CAPNOGR. VET**  
 Portable multifunctional Capnography monitor providing SpO<sub>2</sub>, Pulse, EtCO<sub>2</sub>, Respiration with accuracy and reliable performance. Light and large LCD display providing graphical SpO<sub>2</sub>, EtCO<sub>2</sub> and Trend function all in one design. Through optional software link to PC via USB. Filter replacement after 8 hours of use. Supplied with adult sensor, AC adapter, sampling tube, airway adapter, filter cartridge, carrying bag, 4 AA rechargeable batteries.

72 hours memory with trend function

**• 33705 FILTER - box of 10**  
**• 33706 SAMPLING TUBE 1.2 m - box of 20**  
**• 33708 VET PROBE - spare**

TECHNICAL SPECIFICATIONS		
SpO <sub>2</sub> Saturation:	Range: 0% to 100%	Accuracy: ±2% between 80% to 100%
Pulse Rate:	30 bpm to 250 bpm	±1% of full scale
EtCO <sub>2</sub> :	Range: 0 mmHg to 100 mmHg	Average: 4 breaths of EtCO <sub>2</sub>
Respiration rate:	0 l/min to 99 l/min	8 breaths of respiration rate
Memory:	72 hours	
Output interface:	USB	
Default Alarm Settings:		
SpO <sub>2</sub> upper limit:	100%	SpO <sub>2</sub> lower limit: 50%
Pulse rate upper limit:	250 bpm	Pulse rate lower limit: 30 bpm
EtCO <sub>2</sub> upper limit:	100 mmHg	EtCO <sub>2</sub> lower limit: 0 mmHg
Resp upper limit:	99 l/min	Resp lower limit: 0 l/min
Power:	4 AA rechargeable batteries 6 volts or AC/DC adapter	

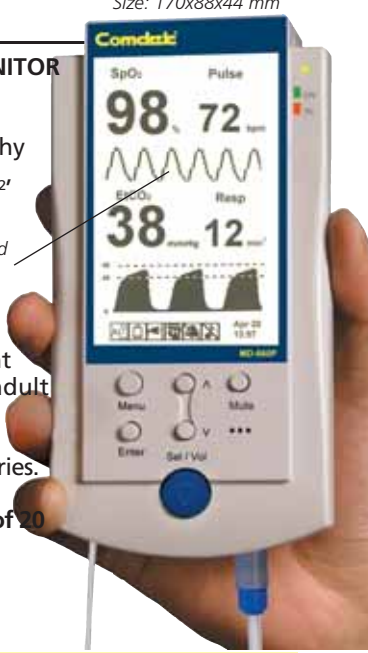

# OXY-50 HANDHELD PULSE OXIMETER



CE 0476  
FDA K090671

Plethysmogram waveform

• **35100 OXY-50 PULSE OXIMETER - with software**  
Pocket fingertip pulse oximeter with colour display for both routine check and continuous monitoring use.

Main features:

- display: 1.8" colour OLED
- resolution: 160x128
- alarm sound, pulse tone
- power supply: DC3V, <100MA
- record: data can be recorded up to 24 hours
- alarm: adjustable high and low limits
- PC software for transferring real time data

GIMA code	ACCESSORIES OXY-50
35105	Adult probe >15 kg - reusable - spare
35106	Pediatric probe 3-15 kg - reusable
35107	Neonatal probe < 3 kg - reusable
35109	Adult neonatal probe* - disposable - 70 cm cable
35108	Extension cable necessary for 35107, 35109 - 2 m

\*Suitable for adult over 40 kg (finger) or neonate less than 3 kg (foot)



Supplied with one adult probe, 2 AA batteries, USB cable, PC software (GB, IT, PL) and user manual (GB, FR, IT, ES)



## TECHNICAL SPECIFICATIONS

Display mode (OLED display)

Pulse oxygen saturation (SpO<sub>2</sub>): 2 digits  
Pulse rate (PR): 3 digits  
Pulse intensity: bar-graph

Pulse rate

Measuring range: 25 ~ 250bpm  
Resolution: 1 bpm  
Accuracy: ±2bpm or ±2%

SpO<sub>2</sub>

Measuring range: 0 ~ 100%, (resolution 1%)  
Accuracy: 70 ~ 100%: ±2%  
Average value: Calculate the average value every 4 measure value  
Deviation between average value and true value does not exceed 1%

Average pulse rate:

Moving calculate the average pulse rate every 4 cardio-beat's cycle. Deviation between average value and true value does not exceed 1%

Pulse intensity Range:

Continuous bar-graph display, the higher display indicates the stronger pulse

Battery:  
Oxymeter probe:  
Dimension:  
Weight:  
Safe type:

dry battery (2AA)  
wavelength: 660 - 880nm  
110(L)x60(W)x23(H) mm  
about 180g (with dry battery 2AA)  
BF Type

# OXY-100 HAND-HELD PULSE OXIMETER

• **34342 OXY-100 PULSE OXIMETER**  
Compact pulse oximeter for hospital and rescue applications to monitor SpO<sub>2</sub> pulse rate, and perfusion index (PI). SpO<sub>2</sub> can be displayed in numbers with bar-graph of pulse as well as full display of plethysmogram.

Includes adult SpO<sub>2</sub> sensor and extension cable.

Features:

- high accuracy and repeatability
- visual and audible alarm, with adjustable limits
- 384-hours data storage and review (with 1/2/4/8 sec.)

- automatic power-off  
Manual: GB, FR, IT, ES, PT.

• **34344 SOFTWARE**

This software allows to download and store all measurements on a PC through USB port.

- **34345 ADULT SpO<sub>2</sub> CLIP PROBE - reusable - spare**
  - **34351 ADULT SpO<sub>2</sub> RUBBER PROBE - reusable**
  - **34347 PEDIATRIC SpO<sub>2</sub> PROBE - reusable**
  - **34348 EXTENSION CABLE - spare for 34345-34347-34349-34351 - 1 m**
  - **34349 NEONATAL SpO<sub>2</sub> Y-TYPE PROBE - reusable**
- All probes with cable 0.9 m

3 ways switchable display to show: numbers, number and waveform, waveform

Battery status display



## TECHNICAL SPECIFICATIONS

Oxygen saturation range: 35% to 100%  
Pulse rate range: 30 bpm to 240 bpm  
Perfusion index (PI) range: 0.2% to 20%  
Display: oxygen saturation, pulse rate, pulse strength, low battery indicator, perfusion index  
SpO<sub>2</sub> accuracy: not greater than 3% for SpO<sub>2</sub> range from 70% to 100%  
Accuracy defined as root-mean-square value of derivation according to ISO 9919  
Pulse accuracy: ± 2% of full scale  
Range alarm setting: SpO<sub>2</sub> upper limit: 95%  
SpO<sub>2</sub> lower limit: 85%  
pulse rate upper limit 100 - 240 bpm  
pulse rate lower limit 30 - 60 bpm  
Power requirements: 3 alkaline AA size batteries 4.5 V  
continuous working time >30 hours  
Dimensions: 145x74x29 mm - Weight: 210 g  
Warranty: 1 year



Output for USB

High resolution LCD display, backlight to display SpO<sub>2</sub>, PR, Pulse Bar, Pi, and Plethysmogram



Portable and lightweight

CE 0476



# MINDRAY PM-60 PULSE OXIMETER



Size: 55x120x30 mm  
Weight 300 g with battery

- **35060 MINDRAY PM-60 PULSE OXIMETER**  
PM-60 is a miniature, lightweight device capable of **spot-check and continuous monitoring of SpO<sub>2</sub> and pulse rate.**
- Spot Check Mode**
  - auto-standby and power off during the idle status
  - auto-increase the patients IDs
  - non-alarm setting for "sensor off" occasion
- 1-99 IDs for maximum 4,000 sets of measurements
- Continuous monitoring mode**
  - regular alarm handling
  - enable to input patient ID manually
  - view SpO<sub>2</sub> waveform for maximum 96 hours trend
- Other features**
  - suitable for adult and pediatric patients
  - high resolution 2.4" colour LCD display
  - adjustable visual and audible alarms
  - real-time data transfer by infrared technology
  - choose between Lithium-ion or AA alkaline batteries (for up to 36 hours continuous working) depending on your run-time needs
  - protective cover perfect for portable monitoring needs
- Supplied with adult reusable sensor
- **35062 PROTECTIVE COVER - light blue**
- **35063 DATA MANAGEMENT KIT**
- **35064 BATTERY CHARGING KIT (EU)**
- Li-ion battery + charge stand + power cable**
- **35065 PEDIATRIC REUSABLE SENSOR**

35060  
+  
35062



TECHNICAL SPECIFICATIONS	
<b>Performance specifications</b>	
Display:	2.4" colour TFT Resolution: 320x240
Multi displays:	selectable: standard or waveform screen
Trace:	1 plethysmogram waveform
Indicator:	alarm indicator light, power indicator light, pulse tone, alarm sound, button tones
Interface:	dual-purpose socket for connecting SpO <sub>2</sub> sensor and communication cable
IR interface:	infrared link allows downloading realtime patient data to computer
DC power interface:	Charger stand for Li-ion battery
DC power requirements:	input voltage 5V DC Power 1.2A
Battery:	Li-ion battery 24 hours continuous working 3xAA batteries 36 hours continuous working
Trend memory:	Monitoring mode: Resolution: 2s Spot-check mode: Maximum time: 96 h Review of up to 4,000 data Measure up to 99 patients
Alarm:	user adjustable high and low limits 3-level audible and visual alarm
SpO <sub>2</sub> Measurement range:	0~100% ±2% (70~100%)
Resolution:	1% Alarm range: 50~100%
Refreshing rate:	1 s
Averaging time:	7 s (sensitivity set HIGH) 9 s (sensitivity set MED) 11 s (sensitivity set LOW)
Pulse rate Range:	18~300 bpm (±3 bpm non-motion) (±5 bpm motion)
Resolution:	1 bpm Alarm range: 18~300 bpm
Refreshing rate:	1 s
Averaging time:	same as SpO <sub>2</sub>
Type of protection:	Class II with internal electric power supply
Degree of protection:	BF (defibrillation proof)
Protection against ingress of liquid:	IPX 2

# COMDEK HOSPITAL PULSE OXIMETERS

- **34290 MD-600 PULSE OXIMETER with alarms**
  - **34291 MD-630 PLUS PULSE OXIMETER with alarms, printer and USB**
- Light-weight pulse oximeters with high accuracy and reliable performances:
- adjustable SpO<sub>2</sub> and pulse alarm settings
  - quick assessment of oxygen saturation and pulse rate
  - with SpO<sub>2</sub> and pulse rate display
- Pulse oximeter with printer and USB (34291 only)**  
Built-in thermal printer allows immediate data printing.  
36 hours memory (with interval of 6 seconds) or 24 hours (with interval of 4 seconds) with possibility to recall up to 100 records (print out the last records up to 240 seconds).  
Tone function and adjustable volume.
- **34295 THERMAL PAPER - for code 34291**
  - **33704 PC-SMART LINK SOFTWARE - for code 34291**
  - **34292 ADULT FINGER SENSOR over 40 kg - reusable**
  - **34294 CHILD TOE SENSOR 3-15 kg - reusable - need 34299**
  - **34299 EXTENSION CABLE for 34294**

34290



Weight: 240 g

- STANDARD ACCESSORIES (codes 34290-34291)**
- 1 AC/DC Adaptor
  - 1 SpO<sub>2</sub> standard adult sensor
  - 4 AA Batteries - alkaline
  - 1 User manual (GB, IT, FR, ES)
  - 1 Carrying bag

TECHNICAL SPECIFICATIONS (codes 34290-34291)	
Oxygen saturation range:	0% to 100% ± 2% between 80% to 100%; ± 3% between 65% to 79%
Pulse rate range:	30 bpm to 250 bpm ± 1% of full scale
Display:	oxygen saturation, pulse rate, pulse search indicator, low battery indicator
Range alarm setting:	SpO <sub>2</sub> upper limit: 100%, lower limit: 50%; pulse rate upper limit 250 bpm, lower limit 30 bpm
Power requirements:	DC 6 volts by 4 alkaline AA size batteries AC adapter output DC 6 Volts, 600 mA
Dimensions - weight:	172x90x36 mm (34290) - 170x88x44 mm (34291) - 240 g - 300 g (34291) - without battery

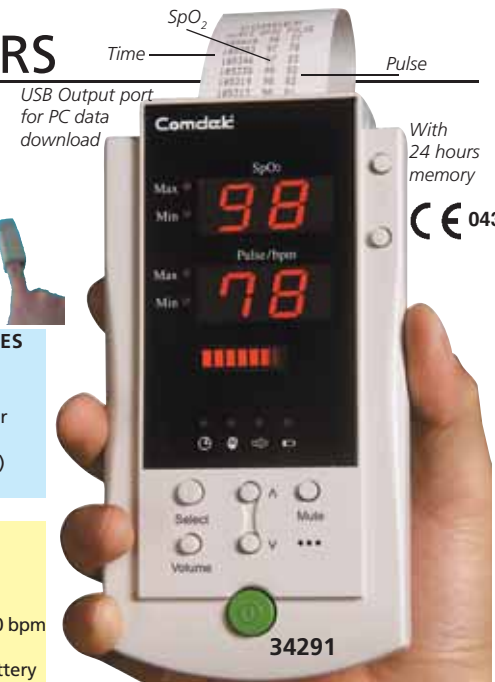

SpO<sub>2</sub>  
Time  
Pulse

USB Output port for PC data download

With 24 hours memory

CE 0434

34291

# OXY 110 PULSE-OXIMETER FOR NEONATES, CHILDREN AND ADULTS

- **34341 OXY 110 PULSE OXIMETER**
- large 3.5 inch auto rotation TFT display for SpO<sub>2</sub>, PI, Plethysmogram, PR and temperature
  - patented MoveOxy™ SpO<sub>2</sub> technology with artifact removal and anti-motion performance
  - various choice of SpO<sub>2</sub> probes for adult, pediatric and neonate
  - in-built lithium battery up to **20 hours continuous monitoring**
  - adjustable alarm limit, pitch tone level, key tone and brightness
  - up to 1,000 hours SpO<sub>2</sub> data storage
  - upgradeable to **infrared ear temperature**
- Supplied with adult probe, charging base, USB cable.
- **34345 ADULT SpO<sub>2</sub> CLIP PROBE - reusable - cable 0.9 m - spare**
  - **34351 ADULT SpO<sub>2</sub> RUBBER PROBE - reusable - cable 0.9 m**
  - **34347 PEDIATRIC SpO<sub>2</sub> PROBE - reusable - cable 0.9 m**
  - **34349 NEONATAL SpO<sub>2</sub> Y-TYPE PROBE - reusable - cable 0.9 m**
  - **35170 EAR INFRARED THERMOMETER**
  - **35171 EAR PROBE COVER for 35170 - box of 500**
  - **34344 SOFTWARE for download and store**

34341

TECHNICAL SPECIFICATIONS	
Technique:	dual wavelength LED
Oxygen saturation range:	35 to 100% ±3%
Pulse rate range:	30 to 250 bpm ±2%
Perfusion index (PI) range:	0.2 to 20%
Display:	3.5" TFT display
Data storage:	up to 1,000 hours
Measuring mode:	continuous or spot check
Power supply:	lithium battery
Charging:	charging stand or USB cable
Dimension:	158x73x25 mm
Weight:	240 g
Data upload:	USB cable or wireless



34341

## OXY-5 AND OXY-6 PROFESSIONAL OXIMETERS



34282

BACKLIT  
DISPLAY



34285

OLED  
COLOUR  
DISPLAY



34285

- 34282 OXY-5 FINGERTIP OXIMETER
  - 34265 OXY-5 PEDIATRIC FINGERTIP OXIMETER
  - 34285 OXY-6 COLOUR FINGERTIP OXIMETER
- To monitor pulse oxygen saturation and pulse rate through patient's finger (10-22 mm finger thickness for 34282, 34285 - 8-16 mm finger thickness for 34265) in medical and hospital environments.

Main features:

- SpO<sub>2</sub> and pulse rate measurement
- bargraph of pulse rate
- perfusion index display. P.I. is a numerical value that indicates the blood perfusion condition at the sensor site. It is a relative value that varies from patient to patient and from measuring site
- high accuracy and repeatability: products are manufactured by GIMA (in P.R.C. facilities) under strong quality controls guaranteed by Italian notified body (CE 0476 CERMET)
- accuracy from the first reading in few seconds thanks to a unique noise rejection capability feature
- extra stability against motion during measurement (finger bending, Parkinson's disease, hand movement, button pressing)

- audible and visible alarms
- automatic power on and power off when finger is out
- low voltage alarm display
- 8 or 9 language manual (GB, FR, IT, ES, DE GR, PT, PL\*, Arabic)
- 50 hours working time with full batteries (30 hours for oxy-6)
- supplied in plastic case with batteries and pouch
- 4 direction adjustable display (Oxy-6 only)

• 35076 CORDURA BAG with belt loop - blue <sup>\*34265, 34282 only</sup>

TECHNICAL SPECIFICATIONS			
	RANGE	ACCURACY	RESOLUTION
Pulse rate:	30-240 bpm	± 2 bpm (2%)	1bpm
SpO <sub>2</sub> :	35%-99%	± 2% (75-99%) ± 3% (50-75%)	1%
Perfusion Index:	0-20%	± 0.1% (0,2-2%) ± 0.2% (2-10%)	0.1%
Alarm:	SpO <sub>2</sub> : low limit 90% Pulse rate: low: < 50 bpm - high > 120 bpm		
Power:	1.5V (AAA size) alkaline battery x 2		
Norms:	IEC 60601-1-2 Class II		
LCD Display:	oxygen saturation, pulse rate, low battery indicator		
Size - weight:	6.6x3.6x3.3 cm - 60 g including batteries		
Italian manufacturer (made in P.R.C.)			

## OXY-3 OXIMETER



35090

DUAL COLOUR  
OLED DISPLAY

CE 2179  
FDA

- 35090 OXY-3 OXIMETER - blister
- Easy to use pocket device, measures oxygen level and pulse rate.

Main features:

- simple operation, small & lightweight design, portable
- display SpO<sub>2</sub>, SpO<sub>2</sub> waveform, PR, Pulse bar
- low power consumption
- 2 AAA alkaline batteries included
- low battery indication, auto power off
- accommodates widest range of finger sizes from pediatric to adult
- soft silicone padding, strong slip
- resistant clip, non-invasive, no pricking
- 4 direction display
- user manual in GB, IT, ES, FR
- 35075 SILICONE COVER - light blue
- 35076 CORDURA BAG with belt loop - blue

Supplied in blister with batteries and lanyard.

35090



35075  
+  
35090

## OXY-4 COLOUR OXIMETER



35091

35092

DUAL COLOUR  
OLED DISPLAY

CE 0123

- 35091 OXY-4 OXIMETER - blue
  - 35092 OXY-4 OXIMETER - orange
  - 35093 OXY-4 OXIMETER - other colour (minimum 100 pieces)
- Select colour with order

- Fingertip pulse oxymeter to monitor pulse oxygen saturation, pulse rate, and perfusion index.
- it is light, small in size and easy to take
  - accurately measures SpO<sub>2</sub> value and pulse rate value
  - dual-color display of SpO<sub>2</sub>, PR, PI, Plethysmogram and pulse bar
  - measuring range, SpO<sub>2</sub> 35 - 99%, Pulse rate 30 - 240 bpm
  - innovative 4 directions display
  - automatic power On/Off
  - more than 30 hours continuous working with 2AAA alkaline batteries
  - audible and visible alarm function
  - battery voltage indication, low battery voltage alarm
  - prevention against water ingress, drop resistant
  - manual in 8 languages: GB, FR, IT, DE, ES, PT, GR, PL
  - 35076 CORDURA BAG with belt loop - blue

## NONIN GO2 OXIMETER



Back light display  
2400 tests performed with one AAA battery (21 hours continued use)



CE 0123

Lead (PB) free and latex free

- 35079 NONIN GO2 - 9570 - IT, FR, DE, NL
  - 35080 NONIN GO2 - 9570 - GB, FR, ES, PT
- GO2 are manufactured to the same technical specifications and technology used in

NONIN professional oximeters, but are dedicated to consumers for people suffering from shortness of breath, fatigue or limited activities.

- highly resistant: it is tested to resist 25 times to fall down from 1 meter, to liquids and to continuative use
  - patient oriented display
  - finger size range from pediatrics to adult
  - easy to read perfusion indicator
  - suitable for low perfusion patient
- Other manuals for download: GR, PL, DK, NO, SE, FI.

### TECHNICAL SPECIFICATIONS

Saturation range: 0-100% ±2 digit (70-100%)  
Pulse rate range: 18-321 bpm ±3 digit (20-250 bpm)

## NONIN ONYX® VANTAGE 9590



Large Bright LED Display SpO<sub>2</sub> and pulse rate can be read from any angle, day or night



The original all-in one digital fingertip pulse oximeter™  
Lead (PB) free and latex free



CE 0123

### • 35085 NONIN ONYX® VANTAGE 9590 PULSE OXIMETER

The Onyx is the only finger pulse oximeter with scientifically proven accuracy in motion and low perfusion, and it is tested for use on fingers, thumbs, or toes.

- **Accurate** - Scientifically proven performance in the widest range of patient populations and settings
  - **Durable** - Protects against dropping and water spills; allows for thousands of uses in the most demanding environments and exceed IP32 water ingress testing
  - **Efficient** - Up to 6000 spot checks or 36 hours of continual operation on two AAA batteries
  - **Safe** - Built in the USA with lead-free and latex-free construction
  - **Versatile** - One unit works on the widest range of patients from pediatric to larger adult patients. Accommodates a wide range of digit thicknesses from 8 mm to 25.4 mm
  - **Warranted** - Industry-leading 4-year warranty
  - **Cost Effective** - Proven accuracy, quality and durability make the Onyx Vantage a smart purchase for the long term
- Supplied with multilanguage CD-rom manual: GB, FR, IT, DE, ES, PT, GR, NL, PL, NO, FI, DK, SE.

### TECHNICAL SPECIFICATIONS

Pulse rate range: 18-321 bpm ±3 digit (20-250 bpm)  
SpO<sub>2</sub> range: 0-100% ±2 digit (70-100%)  
Low perfusion SpO<sub>2</sub>: 70-100% ±2 digit  
Low perfusion pulse rate: 40-240 bpm ±3 digit

## OXY-PED

4 direction OLED colour display



PEDIATRIC

Visual and audible alarms

- 34266 OXY-PED PEDIATRIC OXIMETER  
Similar to OXY-6 but suitable for pediatric use. Input shaped to fit children's fingers thickness 8-16 mm. It is supplied with two rechargeable batteries and USB battery recharger. All other specifications are like OXY-6 model.
- 34270 RECHARGEABLE BATTERY - spare



### TECHNICAL SPECIFICATIONS

	RANGE	ACCURACY	RESOLUTION
Pulse rate:	30-240 bpm	± 2 bpm (2%)	1bpm
SpO <sub>2</sub> :	35%-99%	± 2% (75-99%) ± 3% (50-75%)	1%
Perfusion index:	0-20%	± 0.1% (0.2-2%) ± 0.2% (2-10%)	0.1%
Alarm:	SpO <sub>2</sub> : low limit 90% Pulse rate: low: < 50 bpm - high > 120 bpm		
Power:	3.6V rechargeable batteries		
Norms:	IEC 60601-1-2 Class II		

## OXY-10 OXIMETER - WIRELESS



OLED COLOUR DISPLAY

wireless

### • 35095 OXY-10 FINGERTIP MULTIFUNCTION OXIMETER

Professional oximeter to monitor pulse oxygen saturation and pulse rate through patient's finger (adult, child, neonate).

- wireless Bluetooth technology for transmission to PC Windows (XP and Seven) and Android (need APP). Software for data management
- external pediatric SpO<sub>2</sub> probes available in 4 sizes for pediatric and neonatal use
- large true colour OLED display
- SpO<sub>2</sub>, PR, Pulse bar, P.I. and plethysmogram
- accuracy from the first reading in a few seconds
- extra stability against motion during measurement
- audible and visible alarms with high and low alarm limits adjustable by user

CE 0476

- patient oriented display with automatic change of 4 directions
- 9 languages manual (GB, FR, IT, DE, ES, GR, PT, PL, Arabic)
- Communication protocols on request
- Supplied in nylon bag with batteries
- 35096 PEDIATRIC CLIP PROBE - reusable
- 35097 PEDIATRIC RUBBER PROBE - reusable
- 35094 NEONATAL PROBE KIT - reusable probe + 20 disposable wraps
- 35099 NEONATAL Y-PROBE - reusable

### TECHNICAL SPECIFICATIONS

	RANGE	ACCURACY
Pulse rate:	30-240 bpm	± 2 bpm or 2%
SpO <sub>2</sub> :	70%-100%	± 3%
Perfusion index (PI):	0.2-20%	
Alarm:	SpO <sub>2</sub> : 85-99% Pulse rate: high 100-240 bpm low 30-60 bpm	
Power:	2xLR03 (AAA) Alkaline batteries 3.0 VDC	
Size:	60x33x30 mm	Weight: 35 g

### EXTERNAL PEDIATRIC - NEONATAL PROBES



35094 Neonatal reusable probe with disposable wrap

35099 Neonatal reusable probe

35096 Pediatric clip reusable probe

35097 Pediatric rubber reusable probe

External pediatric SpO<sub>2</sub> probe with 1 m cable

## IPAD CU-SP1 INTELLIGENT PUBLIC ACCESS DEFIBRILLATOR

CU-SP1 is the last generation of intelligent public access defibrillators with innovative features:

**- Auto volume adjustment**

It detects the ambient noise and automatically adjusts the volume of its prompts to make them audible over the background noise.

**- Smart pads - intelligent storage**

The pre-connected "Smart" electrode pads are stored in an easy access compartment on the underside of the unit. This ensures that the iPad SP1 is always ready to be used in the shortest time possible. In addition, the visual frontal indicator shows if the connected pads are within their life expectancy. The indicator will change when the pads have only 3 months life left before their expiry date giving you time to arrange for replacements. It will change again when the expiry date is reached.

**- CPR detection**

CPR ensures that the casualty has the best chances of survival. The CU-SP1 detects if CPR is being performed with appropriate prompts, if not it encourages the responder to perform it.

**- Easy communication with CU-EX1 software**

Installing CU-EX1 software onto a computer allows you to see and analyze the usage history of the unit. Information such as time of "power on", the casualty's heart rhythm and shocks delivered are all clearly presented.

The iPad CU-SP1 can store up to 5 events with up to 3 hours of ECG analysis on an SD memory card.

**- 16 languages available**

(to be indicated with order)

Selectable software languages: US, GB, FR, IT, ES, DE, PT, NL, PL, SE, DK, NO, CZ, GR, AE, KR, IL. On request LT.

Supplied with adult SAVE PADS, carrying bag, disposable lithium battery pack, paper manual (GB, IT) and CD manual in above languages excluding PL and GR.



AHA/ERC 2010 GUIDELINES

5 YEARS WARRANTY

35340



Automatic defibrillator without shock button

35339

### TECHNICAL SPECIFICATIONS

<b>Defibrillator</b>	
Operating mode:	Semi-automatic
Waveform:	e-cube biphasic (Truncated exponential type)
Energy:	150J fixed Adult: nominal 150J at 50 ohm load Infant/child: nominal 50 joules at 50 ohm
Charge control:	controlled by automated patient analysis system
Charging time:	within 10 seconds since voice instruction "an electric shock is needed"
Sealing:	waterjet proof IPX5 per IEC60529 (IP55) dust protected IP5X per IEC60529
<b>User interface</b>	
User support:	detailed voice prompts and flashing indicators
CPR guidance:	voice prompts for how to perform CPR for adult and child
Controls:	on/off button, "i" button, shock button (only 35340)
Indicator:	LCD display (Device status, Battery status, Pads status)
Sensing:	pads expiry date, Pads connection status
CPR Monitoring	
Automatic Volume adjustment	
<b>Data recording and transmission</b>	
IrDA port:	wireless transmission of event data to PC, SD Card
Internal Memory (Nand-flash):	ECG, Event
Storage capacity:	multi recording 5 events / Max 3 hours
Data review PC Programme:	CU-EX1
<b>Patient analysis system</b>	
Patient Analysis:	Shockable Rhythms - Ventricular Fibrillation, Tachycardia
Sensitivity/Specificity	Meets AAMI DF80 Guideline
<b>Disposable high capacity battery</b>	
Standard	Type: DC 12 Volt 4.2 Ah, Lithium manganese dioxide Capacity: Minimum 200 shocks (150J)

GIMA code	IPAD CU-SP1 AED DEFIBRILLATOR
35340	iPad CU-SP1 defibrillator - semiautomatic
35339	iPad CU-SP1 defibrillator - automatic
ACCESSORIES FOR CU-SP1	
35342	Trainer Defi Pads - kit of 2
35343	Trainer - 16 selectable software languages
35344	Adult PADS - kit of 2 pcs - disposable
35345	Pediatric PADS - kit of 2 pcs - disposable
35346	Disposable lithium battery LiMnO <sub>2</sub> high capacity 4.2 Ah
33423	Wall cabinet with sound alarm
35349	SD card+ software for event recording download

## METAL CABINETS FOR DEFIBRILLATORS - INDOOR OR OUTDOOR

### METAL CABINETS FOR DEFIBRILLATORS - INDOOR USE

- 35330 METAL CABINET - INDOOR USE - white
- 35331 METAL CABINET WITH ALARM - INDOOR USE - white  
Door with opening at 180° with transparent acrylic window. Suitable for wall mounting or use with pole. Horn alarm at 100 dB (only 35331)
- 35333 POLE for cabinet - white

### METAL CABINETS FOR DEFIBRILLATORS - OUTDOOR USE

- 35334 METAL CABINET - OUTDOOR USE - yellow  
Water tight welding on the sides, water and dust proof gaskets. Made in carbon steel, thickness 15/10. Adjustable internal shelf. Door with transparent acrylic window.
- 35335 METAL CABINET WITH THERMO REGULATION SYSTEM AND ALARM - OUTDOOR USE - yellow  
Same as 35334, with antitheft magnetic sensor that activates a 100 dB siren in case of non authorized withdrawal. 9V alkaline battery for alarm. Low charger indicator. Power 230V for thermoregulation. Suitable for wall mounting or use with pole.
- 35337 POLE for cabinet - yellow

### INDOOR USE



External size: 42.5x16xh 42.5 cm  
Internal size: 40x13xh 40 cm

### OUTDOOR USE



External size: 43x21xh 48 cm  
Internal size: 42x20xh 45 cm

IP 44 PROTECTION

# iPAD CU-SP2 AED MODE DEFIBRILLATOR



**• 35341 IPAD CU-SP2 DEFIBRILLATOR - AED MODE**  
 CU-SP2 is the last generation of intelligent public access defibrillators with innovative features:

- **Auto volume adjustment**  
 It detects the ambient noise and automatically adjusts the volume of its prompts to make them audible over the background noise.
- **Smart pads - intelligent storage**  
 The pre-connected "Smart" electrode pads are stored in an easy access compartment on the underside of the unit ensuring use in the shortest possible time. In addition, the visual frontal indicator shows if the connected pads are within their life expectancy. The indicator will change when the pads have only 3 months life left before their expiry date giving you time to arrange for replacements. It will change again when the expiry date is reached.
- **CPR detection**  
 CPR is vital to ensure that the casualty has the best chances of survival. iPAD CU-SP2 detects if CPR is being performed with appropriate prompts, if not it encourages the responder to perform it.
- **Easy communication with CU-EX1 software**  
 It allows to see and analyze information such as time of "power on", the casualty's heart rhythm and shocks delivered. It saves 3 events on the internal memory (up to 17 hours per event).
- **Wireless ECG transmission device (CU-EM1) - optional**  
 In monitor mode, iPAD CU-SP2 uses Bluetooth to receive ECG data from CU-EM1 and displays it on the LCD screen.
- **Printer - optional**  
 iPAD CU-SP2 supports connection to an external Bluetooth printer.
- **16 languages available**  
 Selectable software languages: GB, FR, IT, ES, DE, PT, NL, SE, PL, FI, DK, NO, CZ, GR, UA, KR.  
 Supplied with adult SAVE PADS, carrying bag, disposable Li-ion battery pack, paper manual (GB, IT) and CD manual in above languages excluding PL and GR. Warranty 5 years.

TECHNICAL SPECIFICATIONS	
<b>Defibrillator</b>	
Operating mode:	Semi-automatic
Waveform:	e-cube biphasic (Truncated exponential type)
Energy:	AED mode: 150/200J fixed or 150-150-200J energy escalating Manual mode: 2-200J, R-Sync
Charging time:	within 10 seconds
Charging time after CPR finished:	at least 6 seconds
Sealing:	waterjet proof IPX5 per IEC60529 (IP55) dust protected IP5X per IEC60529
<b>User interface</b>	
User support:	detailed voice and text prompts
CPR guidance:	voice prompts for how to perform CPR for adult and child
Controls:	on/off button, "i" button, shock button, soft keys
Indicator:	graphic LCD display (status, user's guide, ECG, heart rate, .....
Sensing:	pads expiry date, pads connection status
CPR Monitoring, ECG Monitoring, Automatic Volume adjustment	
<b>Data recording and transmission</b>	
IrDA port:	wireless transmission of event data to PC, SD Card
Internal Memory (Nand-flash):	ECG, Event
Storage capacity:	multi recording 3 events / Max 17 hours for each event
Bluetooth:	communication with the printer
Data review PC Programme:	CU-EX1
<b>Patient analysis system</b>	
Patient Analysis:	Shockable Rhythms (Ventricular Fibrillation, Tachycardia)
Sensitivity/Specificity	meets AAMI DF80 Guideline
<b>Battery</b>	
Rechargeable battery Type:	DC 11.1 Volt 1.9 Ah, Li-ion rechargeable
Capacity:	Minimum 60 shocks or 3 hours of operation
Standard Type:	DC 12 Volt 4.2 Ah, Lithium manganese dioxide
Capacity:	Minimum 200 shocks (150J)

ACCESSORIES FOR CU-SP2	
<b>35344</b>	Adult PADS - kit of 2 pcs - disposable
<b>35345</b>	Pediatric PADS - kit of 2 pcs - disposable
<b>35346</b>	Disposable Lithium battery LiMnO <sub>2</sub> high capacity 4.2 Ah - spare
<b>35347</b>	Rechargeable 12 V, 1.9 Ah Li-ion battery - optional
<b>35348</b>	Battery charge dock + battery charger for 35347
<b>35349</b>	SD card+ software for event recording download
<b>35350</b>	Wireless ECG for CU-SP2
<b>35351</b>	Wireless printer for CU-SP2

# COMPATIBLE DEFIBRILLATOR ECG THERMAL PAPER - DIFFERENT BRANDS

GIMA code	MANUFACTURER AND MODEL	Type	Width mm	Length m	Sheet	Marker	Grid*	Min. order	GIMA code	MANUFACTURER AND MODEL	Type	Width mm	Length m	Sheet	Marker	Grid*	Min. order
33100	CORPLUS Corplus 3	roll	106	20	-	no	or/red	10	33102	PHILIPS Defibrillator MRX	roll	75	25	-	no	or/red	10
32968	MINDRAY Beneheart D3, D6	roll	50	20	-	no	or/red	20	33103	Heartstart XL	roll	50	30	-	no	or/red	20
33103	HEWLETT PACKARD 40457C/D, Codemaster 100, XL	roll	50	30	-	no	or/red	20	33032	PHYSIO CONTROL Life Pack 8-9-10	roll	50	23	-	no	or/red	20
33029	NIHON KOHDEN Def. TEC 5521, 5531, BSM 2300, 3000	pack	50	100	200	no	or/red	25	33033	Life Pack 11-12-15	roll	107	25	-	no	or/red	10
32988	Tech-8300	roll	50	30	-	no	or/red	20	32983	SCHILLER Defigard 6002	pack	80	70	300	yes	or/red	20
									33106	ZOLL Defi/1400 (P/N 8000-0300)	pack	90	200	yes	or/red	20	

\*or/red: grid could be orange or red colour

\*If used during 5 years battery should be replaced

# i-PAD NF 1200 PUBLIC ACCESS DEFIBRILLATOR

Semi-automatic external defibrillator designed for minimally trained individuals. It provides simple and direct voice prompts and indications for a straightforward rescue operation. Lightweight and battery powered for maximum portability. Designed to treat Ventricular Fibrillation (VF) and Fast Ventricular Tachycardia: the most common causes of sudden cardiac arrest (SCA). In SCA, the heart of the victim suddenly stops pumping. The only effective treatment for VF is the application of a defibrillating shock. It may be used on children 1-8 years old (less than 25 kg) with pediatric reduced energy pads, over with adult pads. Supplied with a set of adult pads, lithium battery (200 Shocks or 10 hours operating time), manual. According to ERC Guidelines 2010.

**TRAINER:** simulates all the functions of i-PAD, with 8 rescue scenarios.



Voice version and manual	i-PAD DEFIBRILLATOR AND TRAINER					
	Spanish	French	Portuguese	Italian	English	Other languages*
<b>DEFIBRILLATOR</b>	<b>33408</b>	<b>33409</b>	<b>33413</b>	<b>33414</b>	<b>33416</b>	<b>33417</b>
<b>TRAINER</b>	-	-	-	<b>33424</b>	<b>33405</b>	<b>33406</b>

\*Voice languages: DE, DK, KR, JP, NL, SE, with same language manual, updated to ERC guidelines 2010  
\*Voice languages: CZ, GR, HU, IL, IR, NO, TR, with English manual, updated to ERC guidelines 2005

GIMA code	Original accessories for I-PAD
<b>33418</b>	Lithium battery pack for i-PAD and i-PAD trainer (for 200 Shocks)
<b>33441</b>	Disposable pads - kit of 2 pcs
<b>33443</b>	Disposable pediatric pads - kit of 2 pcs
<b>33422</b>	Carrying bag
<b>33423</b>	Wall cabinet with alarm sound
<b>33403</b>	IrDa connector for data communication + software for event recording download with key file

CE 0470  
JFDA

SPECIALLY DESIGNED FOR PUBLIC USAGE



TECHNICAL SPECIFICATIONS	
Operating mode:	Semi-automatic
Waveform:	e-cube biphasic (Truncated exponential type); impedance compensated
Energy:	200J fixed Adult: nominal 200J into a 50 ohm load Infant/child: nominal 50 joules into a 50 ohm load
Shock energy accuracy:	Within ±3% (200J into 50 Ω)
Shock to shock cycle time:	Typically less than 20 seconds
Protocol:	Voice prompts and indicators guide through protocol
Charge control:	Automatic by Software (Arrhythmia Detection System and Charging Control)
Charge time from "Shock advised":	< 10 seconds, typical
Voice instruction:	Voice messages guide through use of defibrillator
Controls:	Shock Button, i-Button, On/Off Button
Indicators:	7 LEDs (different colours), i-Button
Patient isolation:	Type BF, defibrillation protected
Battery:	12 Volt DC, 4.2 Ah, lithium manganese dioxide, disposable long-life primary cell
Battery capacity:	Min. 200 Shocks or 4 hours of operating time
Data recording:	Data Stored: First 40 minutes of ECG and the entire incident's events and analysis decision
Size - Weight:	220x260x70 mm - 2.2 kg (4.84 lbs) with battery pack

# RESCUE SAM AED DEFIBRILLATORS - SEMI OR FULL AUTOMATIC

5 YEARS WARRANTY MADE IN ITALY

Rescue Sam with carrying bag 33421

33425 + 33421

Semi automatic



Full automatic



Semi or full automatic external defibrillators designed for public use by minimally trained people. They provide easy and simple indications for rescue operations. Designed to treat Ventricular Fibrillation (VF) and Fast Ventricular Tachycardia (VT). Supplied with lithium battery, set of adult pads and manual. According to AHA/ERC Guidelines 2010. Made in Italy.



RESCUE SAM DEFIBRILLATOR - Semi automatic				
English	Italian	French	Spanish	Other languages*
<b>33425</b>	<b>33426</b>	<b>33427</b>	<b>33430</b>	<b>33559</b>

Other languages available in 20 days: DE, PL, RU (manual and voice), PT, CZ, FI, GR, LT, NL, RO, TR, KR, TH (voice with English manual)

RESCUE SAM DEFIBRILLATOR - Full automatic				
English	Italian	French	Spanish	Other languages*
<b>33165</b>	-	<b>33167</b>	-	-

German available on request in 20 days

TRAINER FOR SEMI-AUTOMATIC RESCUE SAM				
English	Italian	French	Spanish	Other languages*
<b>33170</b>	<b>33171</b>	-	-	<b>33174</b>

Trainer: other languages available in 20 days: ES, FR, PL (voice only)

GIMA code	ACCESSORIES FOR RESCUE SAM DEFIBRILLATORS
<b>33558</b>	USB PC interface
<b>33419</b>	Lithium battery pack
<b>33458</b>	Disposable pediatric pads (kit of 2)
<b>33451</b>	Disposable adult pads (kit of 2)
<b>33420</b>	Disposable adult pads (kit of 2) and cable
<b>33421</b>	Carrying bag

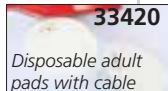

TECHNICAL SPECIFICATIONS	
Operating mode:	Semi-automatic or Full-automatic
Waveform:	BTE (Biphasic Exponential Truncated); impedance compensated
Energy:	200 J fixed
Charge control:	Automatic by software (Arrhythmia Detection System and charging control)
Charge time:	< 8 seconds, typical with new battery
Shock delivery vector:	adult pads in the anterior (Lead II) position or reduced energy paediatric pads in anterior-posterior position
Voice instructions:	Vocal and optical message guide
Automatic manual tests:	Battery insertion test and daily self tests
Long life lithium battery:	12 Volt DC, 4.2 Ah, LiMnO, disposable
Battery capacity:	200 shocks or 4 hours of continuous operating time
Data recording, stored:	first 60 minutes of ECG and the entire incident's event
Size-weight:	30x28xh 9 cm - 2.3 kg with battery



**TRAINER AED RESCUE SAM PRO**  
Designed to effectively train emergency responders to the use of RESCUE SAM, thanks to simple, clear, spoken and visual instructions. 5 pre-programmed scenarios selected directly by the remote control. Totally safe real shock simulation. Supplied with remote control, training pads, battery charger.

# COMPATIBLE PADS FOR OVER 90% OF DEFIBRILLATORS ON THE MARKET



## ADULT COMPATIBLE PADS - disposable

A range of compatible pads BSI certified for patients >8 years (25 kg) for most defibrillators on the market. Excellent adherence and adequate gel thickness. Includes a couple of pads, cable and connector. Maximum shelf life 30 months from production date. Latex free.

Compliance to regulations: Directive 93/42/EEC and amendments. Class IIb medical device. ANSI/AAMI: DF-80; IEC/EN: 60601-1, 60601-2-4; ISO: 10993-1. Made in Italy.

GIMA code	BRAND	MODEL	GIMA code	BRAND	MODEL
33576	Agilent-Philips	- Heartstream/HeartStart XL M4735A - Heartstream/HeartStart XLT M3500B - HeartStart XL 861290 - HeartStart 4000 M5500B (all with Philips cable M3508A)	33587	Mindray	- Beneheart D3 - Beneheart D6
33577	Agilent Hewlett-Packard	- Codemaster 100-XE-XL-XL+ - Heartstream XL, XLT, XL+ with cable M3507A	33579	MRL	Life - Lifequest
33579	Artema Innomed	- Cardio Aid 100 - 200 - 200B - 360B - XL - XL+	33579	Nihon Kohden	Cardiolife TEC 2202 - 2203 - 5500 - 7531 - 7600 - 7700 - 8251 all with cable JC-755V, TEC 8300 with cable JC855V
33579	Artema S&W	- Cardio Aid LS - MC - MC+	33587	Osatu Bexen	- Reanibex 200 - 300 - 500 - 700 - 800
33587	Cardioline	- Elife 700	33576	Philips Laerdal Medical	- Heartstream Fore Runner I AED models E, S, EM - Heartstart FR1 AED 940010XX - 940020XX - 940030XX - Heartstart FR2 AED M3841A - M3861A - Heartstart FR2+ AED, with ECG module M3840A, M3860A - Codemaster M1722A/B, M1723A/B, M1724A, M2475B (with Philips cable M3507A and pad adapter 05-200) - Heartstart MRx M3535A (with Philips cable M3508A)
33448	Cmos Drake	- Futura	33588	Schiller	- Fred Easy - Fred Easy 2G - Defigard DG4000 - DG5000 - DG6002
33448	CU Medical System	- i-PAD NF1200	33586	Schiller	- Defigard DG1002 - DG3002 - DG2000 EDOS
33578	Defibtech	- DDU 100 Lifeline AED - DDU 120 Lifeline Auto AED	33592	Schiller	- Fred easy port - Argus PRO Lifecare - Argus PRO Lifecare 2 - Cardiovit AT 101 Easy
33579	Drager	- Cardiolog 2000	33579	S&W	- Cardio Aid LS - MC - MC+
33586	Esaote	- MDF SAED - MDF II	33579	Welch-Allyn	- AED 10 - AED20 - PIC30 - PIC40 - PIC50
33579	Innomed	- CardioAid 200B - 200 - 100 - 360B - XL+ - XL	33589	Zoll Medical Corp	- Zoll PD 1200 - 1400 - 1600 - 1700 - 2000 - M series - E series - R series
33577	Laerdal Medical	- HeartStart 4000			
33589	M&B	- AED 7000			
33587	Medtronic-Physiocontrol	- Lifepak 9 connector Quick-Combo - Lifepak 10 - 12 - 15 - 20 - 500 AED pink or grey socket - 1000 AED			
33609	Metrax Primedic	- Heartsave AED - AED-M - 6 - 6S since S.N. 739xxxxxxx - Defimonitor XD			

Connectors to defibrillator of compatible pads

Multilanguage envelope: English, Italian, French, German, Spanish, Portuguese, Greek, Dutch, Russian, Swedish

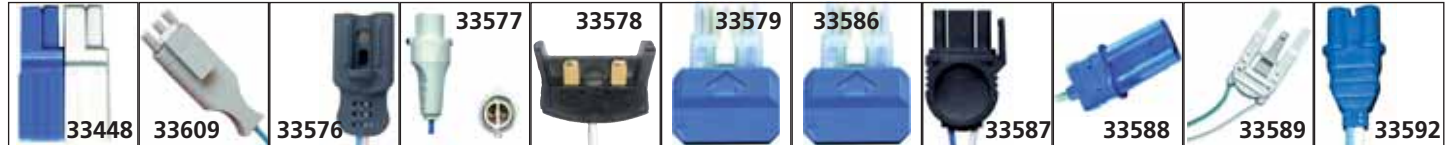

# PEDIATRIC COMPATIBLE PADS WITH ENERGY REDUCTION SYSTEM

## PEDIATRIC COMPATIBLE PADS - disposable

These pads have an energy reduction system: defibrillator output of 150J (33606) or 200J (33603) is reduced to 50J. International RCP guidelines state 8 years as limit age for

pediatric treatment, corresponding to about 25 kg according to standard growth curves. Compliance to regulation as above adult compatible pads. Latex free. Made in Italy.

GIMA code	BRAND - MODEL	GIMA code	BRAND - MODEL
33603	Medtronic-Physiocontrol - Lifepak 500 AED pink socket - Lifepak 1000 AED - Lifepak CR plus AED - Lifepak Express AED	33603	Philips Laerdal Medical - Heartstart FR2 AED M3841A & M3861A - Heartstart FR2 AED, with ECG module 3840A, M3861A

# ORIGINAL CU, PRIMEDIC AND PROGETTI PADS

GIMA code	BRAND - MODEL	GIMA code	BRAND - MODEL
	<b>PEDIATRIC PADS</b>		<b>ADULT PADS</b>
33569	CU Medical System CU-ER1, CU-ER2, CU-ER3	33565	CU Medical System CU-ER1, CU-ER2, CU-ER3
33443	iPad NF 1200	33441	iPad NF 1200
35345	CU-SP1, CU-SP2	35344	CU-SP1, CU-SP2
35390	Metrax-Primedic HeartSave Pad, AED, AED-M, 6, 6S since S.N. 739xxxxxxx	35392	Metrax-Primedic HeartSave Pad, AED, AED-M, 6, 6S since S.N. 739xxxxxxx
33458	Progetti Rescue Sam, Rescue 230, Rescue Life 5.7" and 7"	33388	Progetti HeartSave Pad, AED, AED-M, 6, 6S up to S.N. 738xxxxxxx
		35380	Defimonitor XD1, XD3, XD10, XD30, XD100, XD300, XD110, XD330
		33451	Progetti Rescue Sam, Rescue 230, Rescue Life 5.7 "and 7"

# PRIMEDIC™ EXTERNAL DEFIBRILLATORS - AED

PRIMEDIC HeartSave product range is easy to operate and offers fast operation. Clear voice prompts guide first aiders through the rescue procedure.

## Current controlled defibrillation - CCD

CCD Biphasic technology delivers peak-free current defibrillation on the patient's heart muscle through its individualized, gentle, effective and current-controlled defibrillation pulse. Featuring an escalating defibrillation strategy, HeartSave is impedance compensated and capable of a maximum energy of 360J.

## Effective workflow

HeartSave is designed to help first aiders delivering the most effective life support. Through its advanced workflow, HeartSave supports the rescuer in minimizing the perishock pause as well as no-flow fraction.

## Pediatric mode

At a touch of a button the Paediatric Mode can be promptly selected. No need of dedicated paediatric electrodes and extreme ease of use result in optimized costs of maintenance and prompt operation.

## Fast

It turns on automatically as soon as the cover has been opened and rhythm analysis starts immediately as the pre-connected electrodes are attached to the patient. All accessories (razor, breathing mask, scissors and gloves) are included.

## Status display

Active status display provides comprehensive information on the device's operating status and battery status (daily and monthly self-tests).

## HEARTSAVE PAD and HEARTSAVE AED

Automatic external defibrillator with 3 years life (PAD) or 6 years life (AED) in standby mode with non rechargeable lithium battery.

The HeartSave AED has 4 selectable languages.

## HEARTSAVE AED-M

Same features as HeartSave AED, plus large LCD display for ECG waveform, HR, shockable rhythm counts and other relevant information. AED-M is supplied with non rechargeable lithium battery

## HEARTSAVE 6

For professional and non professional users. In addition to the AED-M features, HeartSave 6 offers both AED and MANUAL mode, 6 leads ECG, alarms and SYNC for Cardioversion.



PRIMEDIC™  
Saves Life. Everywhere.

High resolution LCD monitor gives important information for resuscitation

Connection socket for save pads and ECG cable

Size approx 26x26x8.5 cm

Menu button



EN 1789  
AHA/ERC GUIDELINES 2015 CONFORMITY  
IP55 WATER-CLASS-PROTECTED  
MADE IN GERMANY

33396  
Trigger button for real single-button operation. You can save a life with only one button.  
Status display

HEART SAVE EXTERNAL DEFIBRILLATORS		Voice version and manual			
	<b>WITH LITHIUM BATTERY</b> <b>140 DISCHARGES AT 360J</b> <b>3 YEARS STANDBY</b>	Italian	English	French	Other languages**
	HeartSave PAD	33393	33395	33398	33402

\*\* We can provide following languages (voice + manual): ES, PT, GR, DK, FI, CZ, PL, DE, SE BG, RU, TR, AE, IR, BR, HU, TH, JP, RO, SI, IL. Only voice: MK, HR, FI, NL, LT, IS, IL, KT, TR, IR, BR, JP. Only manual NO.

AED		Voice version and manual			
	<b>WITH LITHIUM BATTERY</b> <b>200 DISCHARGES AT 360J</b> <b>6 YEARS STANDBY</b>	English Spanish Greek Portuguese	Italian French German Polish	Other languages***	
	HeartSave AED HeartSave AED-M	33391 33396	33392 33397	33394 33399	

WITH AKUPAK LITE RECHARGEABLE BATTERY AND CLIP CHARGER		Voice version and manual			
	HeartSave AED-M	English Italian Spanish French	English Spanish Greek Portuguese	Italian French German Polish	Other languages***
	HeartSave 6	33440	-	33453	33446 33456

\*\*\*We can provide following languages (voice + manual): BG, CZ, DK, FI, HR, HU, MK, NL, NO, RO, RU, SE, SI, TR, AE, CN, IR, TH. Please specify with order. Available in 40/60 days.

SAVEPADS	GB, IT, FR, ES	Other languages
Self-adhesive electrode, cable, razor and gloves - shelf life 3 years		
SavePads mini for 1-8 years max 25 kg	35390	35391
SavePads preconnect for over 8 years, 25 kg Since S. N. 739xxxxxxx	35392	35393
SavePads for over 8 years 25 kg Only for 33384/5 and AED sold before April 2014 up to S.N. 738xxxxxxx	33388	33386

ACCESSORIES - SPARES		
Lithium BATTERY - not rechargeable life 6 years for AED and AED-M	33387	33387
AkuPak Lite Rechargeable battery****	33400	33400
PowerPak Battery charger for code 33400	33407	33407
Flashcard ERC guidelines update (2010 to 2015)****	33401	33401

\*\*\*\*For defibrillators sold up to December 2010 - Specify serial number with order \*\*\*\*\*For AED-M and HeartSave

STANDARD ACCESSORIES		
Lithium battery, 3 years stand-by (140 shocks @360J), (PAD only)		
Lithium battery, 6 years stand-by (200 shocks @360J), (AED, AED-M)		
AkuPak Lite, rechargeable battery with clip charger, (AED-M, H56)		
ECG cable 3 leads (HeartSave 6 only)		
SavePads		
Data and voice recording		Manual

\*AED-M is available with lithium battery or with Akupak Lite rechargeable battery. Select code for requested model

	TECHNICAL SPECIFICATIONS				LCD Monitor				
	PAD	AED	AED-M	H56		PAD	AED	AED-M	H56
<b>Defibrillation</b>					95x72 mm (diagonal 4.7"/120 mm)				
Semi-automatic mode	•	•	•	•	320x240 (pixel size 0.36x0.36 mm)				
Manual mode					Storage battery status display				
Wave: biphasic, current controlled pulse	•	•	•	•	Speed 25 mm/s				
Energy 50-360J	•	•	•	•	Heart rate, number of defibrillation, number of VF/VT, total resuscitation time				
Charging time: < 12 sec @ 360J	•	•	•	•	<b>Data backup</b>				
Operating modes: asynchronous	•	•	•	•	Removable memory	•	•	•	•
Paediatric mode	•	•	•	•	Voice recording	•	•	•	•
ECG					<b>Power supply</b>				
Lead: II					Lithium battery 3 years life or 140 discharges at 360J	•	•	•	•
I, II, III, aVR, aVF, aVL					Lithium battery 6 years life or 200 discharges at 200J - 15 hours monitoring				
Patient's impedance range: 23-200 Ohm	•	•	•	•	AkuPak Lite with rechargeable battery			•	•
Heart rate: 30-300 per min	•	•	•	•	100-240 V, 50/60 Hz - 150 discharges at 200J			•	•
<b>VF:VT Detection</b>					- 5 hours monitoring				
VF/VT Detection	•	•	•	•	<b>Status display</b>				
Analysis time 7-12 sec	•	•	•	•	Defibrillator and battery status visualization	•	•	•	•
Asystole threshold <0.2mV	•	•	•	•					
Artefact-Pacemaker detection	•	•	•	•					
<b>Electrodes</b>									
Non polarized electrodes, cable length 2 m	•	•	•	•					

# PRIMEDIC™ DefiMonitor XD - PROFESSIONAL DEFIBRILLATORS

## DEFIMONITOR XD

The sophisticated high performance instrument with multifunctional features.

It combines a compact product design, proved and tested in practice with the highest possible degree of safety and user friendly handling.

Range of 8 manual (XD1, XD3, XD10, XD30) or manual + AED (XD100, XD300, XD110, XD330) defibrillators with or without SpO<sub>2</sub> and external pacer.

Supplied with adult/pediatric paddles, disposable adult Save Pads, connect cable, ECG cable, power cable, 1 tube gel, 1 paper roll.

Standard software: GB, FR, DE, IT, ES, KT, PT, RO, TR, CN.

Manual: GB, IT (on request DE, ES, PT, RU, UA).

Other softwares available on request: CZ, FI, HU, NL, NO, PL, RU, SE, DK, GR, LT, JU, AE, BR, CN, IR, JP, TH, US.



Size: 33x29x16 cm

EN 1789

MADE IN GERMANY

GIMA code	DefiMonitors XD
35370	DefiMonitor XD1 manual
35371	DefiMonitor XD3 manual + SpO <sub>2</sub>
35372	DefiMonitor XD10 manual + pacer
35373	DefiMonitor XD30 manual + SpO <sub>2</sub> + pacer
35374	DefiMonitor XD100 manual + AED
35375	DefiMonitor XD300 manual + AED + SpO <sub>2</sub>
35376	DefiMonitor XD110 manual + AED + pacer
35377	DefiMonitor XD330 manual + AED + SpO <sub>2</sub> + pacer

GIMA code	Accessories for DefiMonitors XD
35380	SAVE PADS Connect GB, FR, IT, ES (require cable 35384)
35383	SAVE PADS Connect other languages (require cable 35384)
35384	Connect cable for SAVE PADS Connect 35380/3 - spare
33400	AKuPak LITE rechargeable battery
35386	Charge base for 33400 for DefiMonitor XD
35387	Paper roll 58 mm x25 m - box of 10
35388	DefiMonitor carrying bag with shoulder strap

	TECHNICAL SPECIFICATIONS																
	XD1	XD3	XD10	XD30	XD100	XD300	XD110	XD330									
<b>Defibrillation</b>									<b>TFT LCD blue-mode monitor</b>								
Wave: biphasic, current controlled impulse	•	•	•	•	•	•	•	•	115x86 mm (diagonal 5.7"/144 mm)	•	•	•	•	•	•	•	•
Energy (automatic mode) 140-360 J	•	•	•	•	•	•	•	•	320x240 pixels	•	•	•	•	•	•	•	•
Manual energy stages:									<b>Electrodes</b>								
5J, 10J, 20J, 30J, 50J, 100J, 200J, 300J, 360J	•	•	•	•	•	•	•	•	Adhesive electrodes, 3 years shelf life	•	•	•	•	•	•	•	•
Charging time: < 6 sec at 200 J	•	•	•	•	•	•	•	•	Cable length 3.5 m Save pads connect	•	•	•	•	•	•	•	•
Cardio version: manual activation, QRS marker	•	•	•	•	•	•	•	•	<b>Data backup</b>								
<b>ECG</b>									Removable memory 2 GB	•	•	•	•	•	•	•	•
Derivation: Eindhoven I, II, III	•	•	•	•	•	•	•	•	Data/Voice recording up to 35 h	•	•	•	•	•	•	•	•
Goldberger, aVR, aVF, aVL	•	•	•	•	•	•	•	•	<b>Power supply</b>								
Patient's resistance: 23-200 Ohm	•	•	•	•	•	•	•	•	Voltage 90-264 V, 50/60 Hz	•	•	•	•	•	•	•	•
Heart rate: 30-300 per min	•	•	•	•	•	•	•	•	<b>Rechargeable Lithium-ion battery (LiFePO<sub>4</sub>):</b>								
<b>VF: recogniton</b>									Capacity 2.5 Ah Voltage: 13.2 Vdc	•	•	•	•	•	•	•	•
VF recogniton	•	•	•	•	•	•	•	•	Discharges 160-200 J	•	•	•	•	•	•	•	•
Analysis time 7-12 sec	•	•	•	•	•	•	•	•	Monitoring 5.30 h Charging time: 3.2 h	•	•	•	•	•	•	•	•
VF threshold 200 µV	•	•	•	•	•	•	•	•	<b>Resuscitation guidelines</b>								
Asystole threshold < 200 µV	•	•	•	•	•	•	•	•	AHA/ERC	•	•	•	•	•	•	•	•
Artefact, Pacemaker detection	•	•	•	•	•	•	•	•	<b>Standards</b>								
<b>Pulse Oximeter</b>									IEC60601-1-1:1988+A1:1991+A2:1995	•	•	•	•	•	•	•	•
Nellcor Oximax	•	•	•	•	•	•	•	•	(Electrical Safety of Med. Electrical Devices)	•	•	•	•	•	•	•	•
<b>Pacer</b>									IEC60601-1-2:2001 (Electromagnetic compatibility)	•	•	•	•	•	•	•	•
Transthoracic heart pacemaker	•	•	•	•	•	•	•	•	IEC60601-1-4:1996+A1:1999	•	•	•	•	•	•	•	•
Modes: fix, demand, overdrive	•	•	•	•	•	•	•	•	(Programmable electrical medical systems)	•	•	•	•	•	•	•	•
<b>Thermal printer</b>									IEC60601-2-4:2002 (Defibrillators)	•	•	•	•	•	•	•	•
Resolution: 200 dpi	•	•	•	•	•	•	•	•	EN1789:2003 (Ambulance standard)	•	•	•	•	•	•	•	•
Advance: 25 mm/s, 50 mm/s	•	•	•	•	•	•	•	•	Protection class IP33	•	•	•	•	•	•	•	•

# DEFI-B BATTERY DEFIBRILLATOR - MADE IN GERMANY



33380

*In emergency situation the well structured and logical operator guidance may save a life*

*Suitable for adult and children (reference norms ERC 2005 use of joule depending on kg).*

*Compact and handy: PRIMEDIC DEFI-B is easily transportable and immediately ready to use everywhere*

## • 33380 DEFI-B DEFIBRILLATOR - 220 V

The mobile security: PRIMEDIC DEFI-B is a state-of-the-art accumulator-driven defibrillator. It was designed in accordance with strict requirements of emergency medical science. Fully developed and reliable technique, world-wide in use since years. PRIMEDIC DEFI-B is

a battery supplied version and has proved successful in daily use in ambulances, with cardio sport groups and in hospitals. The convincing advantages: PRIMEDIC DEFI-B is immediately ready for application and is not depending on the main power supply due to large accumulator capacity. After switching on, the defibrillator carry out an internal self-test. In order to ensure a functional optimal handling, the user is supported by clear instructions and pictograms. A shock-resistant plastic casing protects the device, especially under rough conditions.

## • 33381 SPARE BATTERY

### TECHNICAL SPECIFICATIONS

Mode: Asynchronous, external defibrillator  
 Energy step: 20, 50, 100, 160, 250, 360 Joule  
 Discharges: 45 shocks at 360 Joule, (10 reserve after signal "battery low")  
 Charging time: 2 sec up to 100 Joule, 4.5 sec up to 360 Joule  
 Paddles for children integrated  
 Accumulator: 14.4 V / 1.4 Ah  
 Charging time: 3.5 hours  
 Safety: Internal discharge of energy after 15 sec. Internal self-testing and fault recognition  
 Protection class II, type BF  
 Mains voltage: 200-240 V 50/60 Hz  
 Dimensions: 40x48x12 cm (W x D x H)



Weight: 8.5 kg

# RESCUE 230 BIPHASIC MANUAL DEFIBRILLATOR

## RESCUE 230 BIPHASIC MANUAL DEFIBRILLATOR

A range of 2 professional models with advanced features:

- BTE (Biphasic Truncated Exponential) discharge type
- impedance compensated energy delivery
- energy selection from 2 to 230 joule directly from the front panel
- charge time 5 sec for 230 joule with fully charged battery
- 100 shocks of 230 j with fully charged batteries
- charge/discharge control from the paddles
- ECG 'R' wave synchro mode or async mode
- large (5.7") high resolution backlight LCD display (320x240 dots)
- ECG through the paddles or through patient cable
- adjustable HR and SpO<sub>2</sub> alarms limits

- 33447 RESCUE 230 BIPHASIC DEFIBRILLATOR
- 33457 RESCUE 230 BIPHASIC DEFIBRILLATOR WITH PACEMAKER

(rectangular pulse, pulse duration 22 msec, pulse max amplitude 150 V, stimulation frequency 30 to 150 BPM)

- 33458 DISPOSABLE PADDLES - box of 2 - pediatric
- 33451 DISPOSABLE PADDLES - box of 2 - adult
- 33449 CABLE/ADAPTOR FOR DISPOSABLE PADDLES
- 33439 SpO<sub>2</sub> PROBE
- 33250 THERMAL PAPER



Battery charging car plug on request

33447



Adult and pediatric standard pads



33451

Optional paddles for monitoring

### TECHNICAL SPECIFICATIONS

#### Display:

- large (5.7") high resolution backlight LCD display (320x240 dots)
- ECG through the discharge paddles (1 trace) or through 4 leads patient cable (6 traces): I, II, III, aVR, aVL, aVF
- Automatic change over when plugging the patient cable
- Filters: 50/60 Hz, base line, low pass
- heart rate indicator

#### Printer:

- auto printing mode
- integrated thermal printer for ECG traces and events documentation hardcopy
- paper speed 5, 10, 25 mm/sec (paper width 58 mm)

#### Safety:

- two hands safety shock release
- ECG input insulation CF class
- internal discharge after 30 sec of standby after charge

Power supply: internal Ni-Cd high capacity batteries (charging time 95%: 2 hours)  
universal mains adaptor charger 110/220 VAC, 50/60 Hz

Dimensions: 34x26x13 cm Weight: 5.5 kg Made in Italy

### STANDARD ACCESSORIES

- |                                      |                            |
|--------------------------------------|----------------------------|
| Internal Ni-Cd high capacity battery | Printer                    |
| Carrying case                        | 1 paper roll               |
| Patient cable 4 leads                | 2 reusable paddles         |
| Manual GB, IT, on request ES, TR     | Mains adaptor charger      |
|                                      | Disposable paddle* +cable* |

\*Only for 33457

# AMBU® TRAINING MANIKINS

## • 34044 AMBU® MAN COMPRESSION

A basic instruction and training manikin for the practice of external chest compression that meets recommendations of AHA (American Heart Association) and ERC (European Resuscitation Council). With the size of a normal adult torso, provides a lifelike representation of human anatomy. **Indicator for correct compression** The manikin includes an indicator bar that shows the correct compression depth, changing colour from red to green.



34044

### Compact and portable Easy AED training

Due to the closed shaped torso, defibrillation pads can be placed and AED training can be performed realistically. Weight: 2.0 kg Size: 45x37x25 cm Max compression depth: 7.5 cm Manual in: GB, FR, IT, ES, DE, PT, GR, HU, DK, PL, NO, SE, SI, CZ, TR, JP, CN.

## • 34047 AMBU® MAN BASIC

Cost efficient and reliable training manikin designed to fulfill all requirements for the BLS algorithm training. The closed shaped torso with its anatomical correct landmarks allows trainees to learn and train the use of Automatic External Defibrillators (AED) and the placement of pads. It allows an optimal training of chest compression in combination with realistic ventilation. The unique hygienic system prevents cross contamination. It allows a realistic ventilation resistance and expiration through mouth and nose. The correct compression depth and required ventilation volume can be monitored by the feedback indicator on the manikin. **Ventilation as in real life**



34047

The trainees will feel the realistic airway resistance and the chest will start rising when the head is correctly tilted and air blown into the manikin. Weight: 6.0 kg. Size: 70x37 cm Max ventilation: 1,200 ml Max compression depth: 7.5 cm Manual in: GB, FR, IT, ES, DE, PT, HU, DK, NL, PL, CZ, TR.

- 34039 HEAD BAG - box of 100 pcs

## • 34042 AMBU® AIRWAY MAN I Adjustable stiffness of the chest

**• 34049 AMBU® AIRWAY MAN W with CPR** Adult-sized training manikins that provide an optimal lifelike representation of the human anatomy. **Mechanical instrument** gives you instant feedback on ventilation volume, stomach inflation, chest compression depth in mm and wrong hand position. **PC connection** (34049 only) of Ambu CPR Software Kit, Ambu CPR Printer or USB Interface. **Make intubation possible** with ET tube, Guedel, Laryngeal Mask and combi-tube. Ambu Airway man includes torso with hooks for arms, computer interface with CPR software kit (34049 only), supplied in track suit jacket and training mat. CPR software kit selectable languages: GB, FR, IT, ES, DE, PT, PL, DK, HU, NL, RU, JP.



Jaw thrust possible

34042

Size: 80x35 cm Weight: 13 kg

**• 34043 COMPLETE SET: ARMS, LEGS, TROUSERS AND BAG**



# RESCUE LIFE MANUAL AND SEMIAUTOMATIC DEFIBRILLATORS

Bright, high contrast, wide-angle TFT LCD colour display 5.7" to view simultaneously up to 3 ECG channels

**Ergonomic design.** Impact proof, compact and lightweight. Comfortable and washable carrying bag keeps all accessories at hand and protects Rescue

**RESCUE 7 ONLY:**  
- 7" TFT COLOUR DISPLAY  
- AUTOMATIC SELF TEST

**MADE IN ITALY**

**AVAILABLE WITH:**

- SpO<sub>2</sub>
  - NIBP
  - PACEMAKER
- YOU MAY ORDER UNIT WITH 1 TO 3 OF ABOVE PARAMETERS

**Fast connection.**

User can choose between ergonomic reusable paddles for manual defibrillator or disposable pads for AED defibrillation.

Both types are equipped with a single fast lock connection for reliable rescue operations



Large TFT LCD colour display 7"



Adult and pediatric reusable paddles

## RESCUE LIFE BIPHASIC DEFIBRILLATORS 5.7" and 7"

Rescue Life is an external defibrillator with monitor. It is designed to be used by out-of-hospital and hospital users. Lightweight, transport facility, attractive line, ergonomic shape, studied in every details. It is a complete acute cardiac care response system designed for Basic Life Support (BLS) and Advanced Life Support (ALS) patient management protocols. The IPX4 standard permits the operation under adverse climatic situations. Rescue Life is totally MADE IN ITALY.

### SpO<sub>2</sub> and pacemaker

Range includes models with pacemaker and SpO<sub>2</sub>. ECG module for monitoring (not for diagnosis) includes up to 12 derivations standard 5 leads patient cable (for I, II, III, aVL, aVR, aVF) or optional 10 leads patient cable (for 12 derivations).

### NIBP

The NIBP option is focused on advantage A+ module of SunTech Medical that provides the highest NIBP performance during movements. Suitable for adult, pediatric and neonatal.

### High contrast TFT LCD colour display 5.7" or 7" (Rescue Life 7)

Bright, high contrast, wide-angle colour display for simultaneous view of up to 3 ECG channels

### Data management

The memory is based on a flash disk of 4 GB for 300 recorded hours for all AED models

### Asynchronous and synchronous

- in *asynchronous* defibrillation, Rescue is advised on patients with the following symptoms: unconsciousness, absence of normal breathing and lack of detectable pulse.

- in *synchronous* defibrillation, Rescue Life is advised on patients with ECG's reporting Atrial Fibrillation.

### 3 operation modes: manual, AED, Advisory

- in *manual mode* RESCUE LIFE is intended for use by doctors and trained individuals. Only 3 steps: energy selection from 1 to 230J, energy charge and shock.

- in *AED mode*, RESCUE LIFE is intended for use by personnel authorized by a physician or medical director. The voice prompts and display messages are assisting the operator during CPR operations, charging automatically to 150J when a shock-able ECG rhythm is detected.

- in *advisory Mode*, the system alerts when the shock is necessary leaving the energy level and charging choice to the operator.

### Initialising and system test at switching on of the device (Rescue Life 7 only)

Auto test and fault recognition (Rescue Life 7 only).

### Clinical test

Available on our web site.

### STANDARD ACCESSORIES

- Internal Ni-Mh battery (Rescue 5.7")
- Internal Li-Ion battery (Rescue 7")
- 2 adult and pediatric reusable paddles
- Manual: GB, IT
- Printer
- 1 paper roll
- 2 disposable pads (AED only)
- Main adaptor charger
- Patient cables 5 leads

English	Italian	Other languages	RESCUE LIFE 5.7" DEFIBRILLATORS
33590	33537	33538*	Rescue life defibrillator
33597	33540	33541*	Rescue life defibrillator with SpO <sub>2</sub>
33591	33543	33544*	Rescue life AED defibrillator with pacemaker
33598	33545	33546*	Rescue life AED defibrillator with SpO <sub>2</sub>
33547	33548	33549*	Rescue life AED defib. SpO <sub>2</sub> +NIBP+Pacemaker
		33539**	Rescue life AED defib. other configuration

\*On request we can offer Rescue Life and Rescue Life AED in Spanish and French

\*\*On request we can offer Rescue Life and Rescue Life AED with SpO<sub>2</sub>+NIBP, SpO<sub>2</sub>+Pacemaker (available in GB, FR, IT, ES)

English	Italian	RESCUE LIFE 7" DEFIBRILLATORS
33182	33183	Rescue Life 7 defibrillator
33185	33186	Rescue Life 7 AED
33188	33189	Rescue Life 7 AED defib. other configurations*

\*On request we can offer Rescue Life 7 with SpO<sub>2</sub> NIBP or Pacemaker.

You can choose 1 to 3 of above parameters. \*Available on request manual in FR and ES.

GIMA code	RESCUE LIFE ACCESSORIES
33448	Disposable paddles - box of 2 - adult - compatible
33451	Disposable paddles - box of 2 - adult - original
33458	Disposable paddles - box of 2 - pediatric - original
33593	Cable for disposable paddles
33594	ECG cable 10 leads
33595	Rescue Life bag
33250	Thermal paper
33596	12V car light adapter - inverter

### TECHNICAL SPECIFICATIONS

**Display:**  
- high contrast TFT colour LCD 5.7" (320x240 pixel) or LCD 7" (800x480 dots)  
- ECG through the discharge paddles (1 trace) or through 5, 10 leads patient cable for 3, 6, or 12 traces and SpO<sub>2</sub> value  
Automatic change over when plugging the patient cable  
- filters: 50/60 Hz, base line, EMG  
- heart rate indicator  
**ECG monitoring**  
- bandwidth: 0.5 to 120 Hz (-3db) with filters off  
- speed: 5, 10, 25, 50 mm/sec.  
- gain: 2.5, 5, 10, 20, 40 mm/mV with patient cable; auto with paddles  
- HR digital readout on the display 20 to 300 bpm (± 2%)  
- alarm: settable HR, min 20 bpm, max 250 bpm  
**Pulse oxymetry (SpO<sub>2</sub>) 33540-1-5-6-7-8-9, 33597-8 only**  
- oxygen saturation range: 0 to 100%  
- pulse rate range: 30 - 250 pulses per minute  
- accuracy SpO<sub>2</sub>: 70-100% ± 2 digits for adults using the finger clip sensor  
- SpO<sub>2</sub> Alarms adjustable (min. 50%)  
**Non-invasive pacemaker (33543-4, 33591, 33547-8-9)**  
- rectangular wave  
- operating mode: fixed on demand  
- pulse rate: 0 to 180 ppm adjustable in steps of 5 ppm  
- impulse duration: 22 ms  
- pulse Current: 0 to 180 mA adjustable in steps of 5 mA

- amplitude: MAX 150 V  
**NIBP (33547-8-9 only)**  
- technique: oscillometric  
- accuracy: meets ANSI/AAMI SP10-2002, EN 1060-4  
- patient application: adult/pediatric/neonatal  
- range mmHg adult pediatric neonatal  
systolic 40-260 40-160 40-130  
MAP 26-220 26-133 26-110  
diastolic 20-200 20-120 20-100  
**Printer:**  
- manual, automatic (10" pre and post recording)  
- integrated thermal printer for ECG traces and events documentation including HR/SpO<sub>2</sub> values  
- paper speed: 5, 10, 25, 50 mm/sec.  
- paper width: 58 mm  
**Safety:**  
- two hand safety shock release  
- ECG input insulation CF class  
- internal discharge after 30 sec. of standby after charge  
**Power supply:**  
internal Ni-Mh battery (Rescue Life 5.7")  
internal Li-Ion battery (Rescue Life 7")  
(charging time 95%: 2 hours)  
AC 100-240 VAC, 50/60 Hz  
Memory: internal flash 4 GB up to 300 hours of ECG data, events and usage review  
**General:**  
Dimensions: 36x24x34 cm  
Weight: 5.5 kg with battery

# DTS-3000 SMART PNEUMATIC TOURNIQUET SYSTEM



33138



33138 + 33139



### STANDARD ACCESSORIES

- No pinch single cuff 61x9 cm - red - arm L or thigh S
- No pinch single cuff 80x9 cm - blue - thigh - M
- No pinch single cone cuff 90x12 cm - blue - thigh - L
- No pinch double cuff 57x10 cm - blue - arm - M
- No pinch double cuff 80x15 cm - red - thigh - M
- Air hose                      Power cord                      LOP sensor                      User manual (GB, IT)

### TECHNICAL SPECIFICATIONS

- Max pressure: 800 mmHg
- Voltage: Ac 100-240 V - 50/60 Hz
- Power consumption: 50 W
- Time range: 5-180 min.
- Compressor dimension - weight: 170x210x260 mm - 3 kg

- **33138 DTS-3000 PNEUMATIC TOURNIQUET** - 2 channels for 2 double cuffs or 2 single cuffs with 5 no pinch cuffs
- DTS-3000 provides stable operation, easy setup and effective alarm system for safe surgery in an operation room.

### System features

- 2 channels (4 ports for 2 double cuffs or single cuffs)
- easy settings by touch key operation
- graphic LCD screen: easy checking and cleaning
- operation recording (date, time, pressure)
- LOP (Limb Occlusion Pressure) sensor to check limb occlusion pressure and set automatically the optimized pressure
- self test of pressure and system check
- self air pressure sensor calibration
- safety alarm system (cuff, pressure, battery, time)
- built-in battery (max life time: 12-72 hours)

### Full autoclavable no pinch cuffs included

- no pinching, no damage to the skin
- lower pressure compared to normal cuff (about 50 mmHg lower)
- no leaking (main reason for lower pressure)

### • 33139 TROLLEY

Standard	No pinch	CUFFS for DTS-2000 and DTS-3000	Size	
			Arm	Thigh
-	<b>33141</b>	Single cuff 61x9 cm - red	L	S
-	<b>33142</b>	Single cuff 80x9 cm - blue		M
<b>33160</b>	-	Single cone cuff 70x10 cm		
<b>33161</b>	<b>33144</b>	Single cone cuff 90x12 cm - blue		L
-	<b>33145</b>	Double cuff 57x10 cm - blue	M	
-	<b>33146</b>	Double cuff 80x15 cm - red		M

No pinch arm



Standard arm



### INTENDED USE OF TOURNIQUET SYSTEM

- To be used by qualified medical professionals to temporarily occlude blood flow in patient's extremities during surgical procedures. Tourniquet has been found useful in producing bloodless operation field in surgical procedures involving the extremities including:
- reduction of certain fractures
  - bone grafts
  - Kirschner wire removal
  - total wrist joint replacements
  - tumor and cyst excision
  - replacement of joints in the fingers
  - subcutaneous fasciotomy
  - knee joint replacements
  - nerve injuries
  - replantations
  - amputations
  - tendon repair

## RIESTER INFUSION CUFFS

- **32684 RIESTER METPAK® INFUSION CUFF** - 500 cc - latex free

- **32685 RIESTER METPAK® INFUSION CUFF** - 1,000 cc - latex free

- **32683 RIESTER METPAK® INFUSION CUFF** - 3,000 cc - latex free

Pressure cuff for infusion with high quality chrome-plated gauge Ø 49 mm up to 300 mmHg.

Made in Germany.



32684



Sturdy blue cotton cuff washable at 60°

## ECONOMIC INFUSION CUFF



32680

- **32680 INFUSION CUFF** - 500 cc
- Infusion cuff similar to above. Latex bladder and bulb. Made in Asia.

## PNEUMATIC TOURNIQUET

- **33150 RIESTER PNEUMATIC TOURNIQUET** with adult arm and thigh cuff - latex free bladder

- **33151 CHILD CUFF** 38x8 cm - latex free bladder

- **33148 ADULT CUFF** 57x9 cm - latex free bladder - spare

- **33149 THIGH CUFF** 96x13 cm - latex free bladder - spare

Reliable pneumatic tourniquet used during amputations to restrict blood circulation in the limbs. A robust and accurate manometer provide exact measurements and a long service life.

- sturdy metal pump to produce pressure
- air in the cuff can escape by opening the release valve
- chromium-plated metal manometer with easy-to-read aluminium scale up to 700 mmHg. Supplied with 2 cuffs (upper arm 57x9 cm and thigh 96x13 cm) with latex-free bladders.



33150

# VOLUMETRIC INFUSION PUMP

## • 35200 INFUSION PUMP IP-7700

This pump using peristaltic method is a cutting-edge pump realizing high flow precision with compatibility with I.V. set of various brands through ultrasonic bubble detection. IP-7700 provides simple and easy setup process with its numerical silicon keypad. FND and color LCD provides complete information and user gets the information at one glance. Most infusion condition such as K.V.O. rate, purge rate and bolus can be setup as operating application. Supplied with battery.

### Main features

- **Light and compact design:** light as 3.5 kg, compact design, and easy to use.
- **Standard compatibility with 4 brands of IV SET:** TERUMO (TS PA 200L), BD (A122), KOREAN VACCINE (1 and 2), ARIES. Each pump can be calibrated for up to 9 different IV set.
- **Flexible flow setting and easy operation method:** Flow-setting range of 1~1000 ml/h, 0.1~999.9 ml/h is available for wide range settings and numerical keypad is easy to use for setting flow-volume.
- **Full program dosage feature (option):** it can calculate the right flow rate for a patient and inject promptly.
- **Easy recognition of alarm:** it notifies errors and emergencies with LED light and buzzer, simultaneous visual and audio alarm system.
- **Notifying remaining battery:** battery LED is attached to notify charged battery showing remaining battery and when to recharge.
- **Keep Vein Open feature:** when reached preset value, it converts to low flow speed of 3ml/h (when IV set is 15, 19, 20 drops/ml) or 1ml/h (when IV set is 60 drops/ml) automatically to prevent flow route clog due to blood coagulation.
- **Ultrasonic air bubble detector**
- **Suitable also for VET use**
- **35202 DROP SENSOR - for more accurate dropping control (suggested for ICU and new born)**
- **35211 DOSAGE AND PROFILE PROGRAM need Serial Number**
- **35203 Ni-Cd BATTERY - spare**
- **26073 I.V. SET ARIES - box of 150 (6 bags of 25)**
- **35204 ADAPTER 110 V - 60 Hz - for 35200**

**CALIBRATION TO ANY IV SET BRAND**  
Please send 5 samples of your pump use IV set.  
Delivery in 40 days

Colour LCD

IV clamp included

English and Italian manual

Automatic setup system (flow rate, time, delivery volume)

CE 0120

Numerical silicone key pads

### TECHNICAL SPECIFICATIONS

**Flow volume setting range**  
1~1000 ml/h (1 ml infusion interval)  
0.1~999.9 ml/h (0.1 ml infusion interval)  
**Flow volume error margin** ±5%  
**Infusion limit volume range**  
1~9999 ml  
**Total estimated volume range**  
1~9999 ml  
**K.V.O rate (Keep Vein Open)**  
1 ml/h ~ 10 ml/h adjustable  
**Pump method** Peristaltic method  
**Size (WxDxH)** 100x190x250 mm  
**Weight** 3.5 kg (battery included)

**Rapid flow volume (Purge)**  
1-1000 ml/h adjustable  
**Bolus** 1~1000 ml/h adjustable  
**Alarm features**  
Air in line, occlusion, flow error (free flow), door open, K.V.O. (Infusion completion), standby, low battery, alarm, device malfunction (CPU error), empty container (with optional drop sensor)  
**Special features**  
Keypad lock, retain memory, remaining time, alarm repeat, open system, K.V.O., purge, bolus, occ. level, history call-back.

**Power**  
AC 230V, 50/60Hz and DC9.6V inner source adapter DC 12 / 24V - 2A Switchable at 110V / 60Hz - with adapter 35204  
**Maximum power consumption** 40VA  
**Electric protection levels**  
Class II B, inner source device, CF type  
**Waterproof level** IPX2  
**Battery type** Ni-Mh rechargeable  
**Battery using time**  
4 hrs (when infusing 125 ml/h)  
**Battery recharging time** Minimum 6 hours.  
**Battery life** approx 6 months

# AUTO SYRINGE PUMP

## • 35205 SYRINGE PUMP SP-8800

SP-8800 provides easy syringe installing through one-touch method by slider hook, simple and easy setup process with its numerical silicon keypad. Color LCD displays infusion information dramatically shortcut key manages easy approach for frequent functions. K.V.O. rate, purge rate, bolus and anti bolus can be setup as operating application. Supplied with battery.

### Flexible flow volume setting.

**Full program dosage feature (optional):** it automatically calculates flow rate by patient's weight, injection's mass and melting.

**Keep Vein Open (K. V. O.) feature:** When reached to the preset value, it converts to low flow speed of 0.1 ml/h automatically to prevent flow route clog due to blood coagulation.

**Standard compatibility with 5 major brands of syringes\*:** Setting feature enables you to choose from following syringe brands: BD (Precise), TERUMO, RAYS, PENTAFERTE, KOVA. Each pump can be calibrated for up to 9 different syringes. Alarm and notification feature: It notifies errors and emergencies with LED light and buzzer. Simultaneous visual and audio alarm. Occlusion error range setting: You can set the pressure level of occlusion stage to High, Medium and Low by patient's age condition. Suitable also for VET use.

- **35210 Ni-MH BATTERY- spare**
- **35204 ADAPTER 110 V - 60 Hz - for 35205**
- **35211 DOSAGE AND PROFILE PROGRAM need Serial Number**
- **23857 BD SYRINGES 50 ml LL - box of 60 - BD 300865**

**CALIBRATION TO ANY SYRINGE BRAND**  
Please send 5 samples of your syringe.  
Delivery in 60 days

IV clamp included

Colour display

CE 0120

English and Italian manual

Automatic set-up system (flow rate, time, delivery volume)

Easy and quick installation of syringe, just in five seconds

### TECHNICAL SPECIFICATIONS

**Flow volume setting range**  
Syringe 10ml: 0.1-300 ml/h  
Syringe 20ml: 0.1-400 ml/h  
Syringe 30ml: 0.1-500 ml/h  
Syringe 50ml: 0.1-1,200 ml/h  
**Flow volume error margin** ±3%  
**Infusion limit volume range**  
0.1~999.9ml (0.1 ml infusion interval)  
**Total estimated volume range**  
0.1~999.9ml (0.1ml infusion interval)  
**K.V.O rate (Vein maintaing function)**  
1-10 ml/h adjustable  
**Size (WxDxH)** 220x130x108 mm  
**Weight** 2 kg (battery included)

**Rapid flow volume (Purge)**  
0.1~1200 ml/h adjustable  
**Bolus:** adjustable 0.1~1200 ml/h  
0.1~1000 ml  
**Alarm features**  
Occlusion, K.V.O. (infusion completion), standby, near empty, low battery, device malfunction (CPU error), clamp/handle lever/slider disengaged, syringe disengaged.  
**Special features**  
Keypad lock, shortcut key, retain memory, remaining time, alarm repeat, open system, K.V.O., purge, bolus, anti bolus, occ. level, history call-back.

**Power**  
AC 230V, 50/60Hz and DC9.6V inner source adapter DC 12 / 24V - 2A Switchable at 110V / 60Hz - with adapter 35204  
**Maximum power consumption** 45VA  
**Electric protection levels**  
Class II B, inner source device, CF type  
**Waterproof level** IPX2  
**Battery type** Ni-MH rechargeable  
**Battery using time** 2 hours  
**Battery recharging time** Minimum 6 hrs.  
**Battery life** about 6 months.



\* We can calibrate our pumps for other syringe brands, please provide minimum 5 samples. Availability in 60 days.

## PLASTER COVER FOOTWEAR

GIMA code	PLASTER COVER EU SIZE
28630	N 36
28631	N 37
28632	N 38
28633	N 39
28634	N 40
28635	N 41
28636	N 42
28637	N 43
28638	N 44
28639	N 45
28640	N 46
28641	N 47/48



Upper made of biocompatible synthetic materials mold resistant and breathable

Non-slip rubber sole

Cover plaster footwear to be worn over plaster or similar rigid bandage.

It can be worn immediately after application of the plaster because breathable.

The sizes are the same as for standard shoes, with appropriately increased fit.

The shape is symmetrical, then the same cover can be used indifferently on the right or left foot. Washable at 30°.

## ORTHOPEDIC SUPPORTS

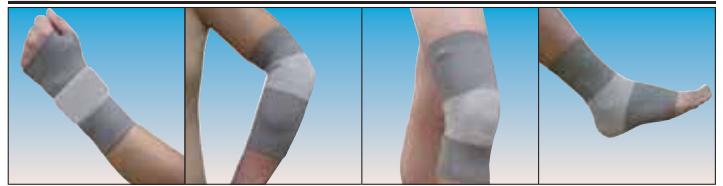

Wrist support    Elbow support    Knee support    Ankle support

Elastic knitting supports to fit body contour. Gel pad inside to release pressure for nerves, muscle, joints and improve stabilization. Hand washable.

Size	WRIST		ELBOW	KNEE	ANKLE	
	Left	Right			Left	Right
S	28731	28741	28751	28761	28771	28781
circumference	15-16 cm		21-23 cm	28-31 cm	19-21 cm	
M	28732	28742	28752	28762	28772	28782
circumference	16-17 cm		23-25 cm	31-34 cm	21-23 cm	
L	28733	28743	28753	28763	28773	28783
circumference	17-18 cm		25-27 cm	34-37 cm	23-25 cm	
XL	28734	28744	28754	28764	28774	28784
circumference	18-19 cm		27-29 cm	37-40 cm	25-27 cm	

## ARM SLINGS



Suitable for supporting a sprained or broken arm during recuperation. The shoulder strap is adjustable to allow a correct positioning of the arm. Stitched from cotton fabric requiring normal laundry care. Fits any arm. Available in 3 sizes.

GIMA code	POUCH ARM SLINGS
28624	Arm sling - small
28625	Arm sling - medium
28626	Arm sling - large

## UNIVERSAL ARM SLINGS



• 28623 UNIVERSAL ARM SLING  
Universal arm sling with adjustable strap and loop contact closure. Fits left and right. Made in comfortable polypropylene material in navy colour. Machine washable.

## SOFT AND RIGID COLLARS

### SOFT CERVICAL COLLARS

This collar is made of soft expanded polyurethane lined with an anti - allergic 100% cotton fabric. Velcro fixing on the back. Available in 3 sizes.

### RIGID CERVICAL COLLARS

Made of polyethylene, with comfortable resting support in vinyl leather and height adjustable. Velcro straps on the back. Available in 3 sizes.

Soft

Rigid



## UNIVERSAL COLLARS



### UNIVERSAL CERVICAL COLLARS

Collars made of foam coated PVC.

Washable, non toxic, with velcro straps.

X-Ray translucent.

Available in 3 sizes or in a set of 3 in a bag.

GIMA code	SOFT AND RIGID NECK COLLARS X-Ray Translucent	CE
34600	Rigid cervical collar 32-40 cm (neck circumference)	
34601	Rigid cervical collar 41-46 cm (neck circumference)	
34602	Rigid cervical collar 47-52 cm (neck circumference)	
34610	Soft cervical collar 43x8 cm - small (h 7 cm)	
34612	Soft cervical collar 46x8 cm - medium (h 8.5 cm)	
34614	Soft cervical collar 49x10 cm - large (h 10.5 cm)	

GIMA code	NECK COLLARS	A	B	C
34050	Set of 3 collars in a bag			
34051	Cervical collar - small	513 mm	87 mm	112 mm
34052	Cervical collar - medium	560 mm	95 mm	123 mm
34053	Cervical collar - large	623 mm	101 mm	132 mm
34054	Bag for 3 collars - blue			

## AMBU® REDI-ACE™



Ambu® REDI-ACE™ Mini is adjustable in 6 sizes

34638



Ambu® REDI-ACE™ Adult is adjustable in 8 sizes

34639

### AMBU® REDI-ACE™ COLLARS

Unique adjustable disposable collar available in 2 versions adult and pediatric for immobilizing of cervical column. With 8 sizes of Ambu® REDI-ACE™ and 6 sizes of Ambu® REDI-ACE™ Mini the majority of patients can be treated. Easy to use, it has an automatic flip up chin and two locking buttons. It can be placed on the patient using only 3 steps; sizing - locking - placement. Made from radiotranslucent material. Packaged completely flat. Latex free.

GIMA code	ADJUSTABLE NECK COLLARS
34638	Ambu® REDI-ACE™ paed.-yellow
34639	Ambu® REDI-ACE™ adult-blue

## AMBU® PERFIT™



Ambu® Mini Perfit™ ACE® is adjustable in 12 sizes

34640



Ambu® Perfit™ ACE® is adjustable in 16 settings from neckless (size 3) to tall (size 6)

34641

### AMBU® PERFIT™ ACE® COLLARS

The Ambu® Perfit™ ACE® extrication collar is a one-piece rigid cervical spine immobilization device, available in 2 versions, adult and pediatric, both adjustable in different sizes/positions. Adult has 16 adjustments, covering neckless, short, regular and tall. Paediatric has 12 adjustments, covering infant, child, small adult. Radiotranslucent CT and MRI compatible it comes with a ventilated, posterior shell for fluid drainage. Made in polyethylene. Flat storage. Latex free.

GIMA code	ADJUSTABLE NECK COLLARS
34640	Ambu® Perfit™ paediatric-yellow
34641	Ambu® Perfit™ adult-white

## PERFIT™ MILITARY

Designed to assist with the maintenance of neutral alignment, prevention of lateral sway and anterior-posterior flexion and extension of the cervical spine during transport.



Ambu® Perfit™ ACE® Militar extrication collar is adjustable in 16 settings

34642

Flat storage



### AMBU® PERFIT™ ACE® MILITARY

Ambu® Perfit™ ACE® is also available in a military version that incorporates a camouflage colour scheme of olive drab body and charcoal black foam and label. The features and specifications are identical to Ambu® Perfit™ ACE®:

- 16 sizes in one collar
- flat storage
- radiotranslucent CT and MRI compatible
- Latex free.

GIMA code	ADJUSTABLE NECK COLLARS
34642	Ambu® Perfit™ Military

## FIRST AID CERVICAL COLLARS



34622



GIMA code	ONE PIECE FIRST AID NECK COLLARS
34620	Infant 44-48 cm - pink
34621	Pediatric 45-48 cm - light blue
34622	Stout (bull-neck) 56-60 cm - yellow
34623	Adult small 56-62 cm - blue
34624	Adult medium 56-64 cm - orange
34625	Adult large - tall 56-66 cm - green
34626	Set of 6 collars in a bag
34627	Bag for 6 collars - green

GIMA code	TWO PIECES FIRST AID NECK COLLARS
34630	Infant 2-6 years 35-99 cm - pink
34631	Pediatric 6-12 years 40- 46 cm - light blue
34632	Stout (bull neck) 48-52 cm - yellow
34633	Adult small 50-54 cm- blue
34634	Adult medium 54-58 cm - orange
34635	Adult large - tall 56-60 cm - green
34636	Set of 6 collars in a bag
34627	Bag for 6 collars - green

### ONE PIECE AND TWO PIECES FIRST AID COLLAR

Made in polyethylene with washable internal part made in EVA (kind of rubber) fixed to structure by plastic rivets. With a tracheal hole, removable chin support and velcro fastener. X-ray translucent. Available in 6 sizes differentiated by safety closure colour or in a set of 6 in a bag.

## AIR CUSHION SPLINTS



• **34106 FIRST AID AIR CUSHION SPLINTS - set of 4 pieces**  
 Indispensable instrument for first aid in case of accidents, cutting and crushing injuries. Prevent surface bleeding without stopping the circulation and secure painless transportation of the injured part. The bandage is a transparent cover of PVC easy to clean and reusable, resistant against water and shifting weather conditions. X-rays can penetrate and medical diagnosis can be made without removing the bandage. The long tube (14.5 cm) with the valve make the inflation of the bandage easy, even by the injured part himself.

**Set of 4 different pieces:** full leg, foot/ankle, full arm, hand/wrist splints in a 4 compartment bag, with inflating pump.

**ALUMINIUM SPLINTS soft lining**  
 With curved edges to avoid harming yourselves. Aluminium thickness 1.2 mm. Made in Italy.

- 34120 SPLINTS - size 13x500 mm
- 34121 SPLINTS - size 19x500 mm
- 34122 SPLINTS - size 24x500 mm



## BOSTON SPLINTS



### • 34123 BOSTON SPLINTS

Adaptable light-weight splints, x-ray translucent, coated with a non-toxic material which can be easily washed and disinfected. Size cm 92x11. Made in Italy.

## FINGER SPLINTS

**FINGER** Set of 8 finger splints in different size (from 5 to 6.5 cm length, from 4.5 to 7.8 cm width circumference). Available in clear and skin tone colours. Made in polypropylene. With holes for air circulation and cooling.

- 34113 FINGER SPLINT KIT - clear - kit of 8
- 34115 FINGER SPLINT KIT - skin - kit of 8



## GIMASPLINTS IN 5 SIZES: LEG, ARM, FOREARM, WRIST AND ELBOW



**GIMASPLINTS** these supports immobilize your limbs in an efficient and practical way. Each splint can be shaped to fit the patient's personal need. It ensures a high degree of rigid support: thanks to inner part made of neoprene lined with 100% laminated, absorbent-proof nylon assembled to a rigid metal splint. A velcro band allows a quick fixing. Available in 5 sizes or in a bag set of 5 pieces.

GIMA code	GIMASPLINTS
34680	Splint for leg - 57 cm
34681	Splint for arm - 60 cm
34682	Splint for forearm - 39 cm
34683	Splint for wrist - 33 cm
34684	Splint for elbow/ankle - 54 cm
34685	Set of 5 splints in a blue bag
34054	Bag for 5 splints - blue



## VACUUM SPLINT KIT

### • 34689 VACUUM SPLINT KIT

The set includes vacuum splints for arm (70x50 cm), leg (100x70 cm) forearm (50x30 cm) and a nylon bag. Produced with high quality materials these splints allow perfect immobilization of the lower and upper limbs by removing the air inside.

Equipped with an outside valve, to avoid troubles to the patient, and three velcro straps.

- 34093 ALUMINIUM PUMP - for vacuum splints and mattress
- 34084 ALUMINIUM MINI PUMP

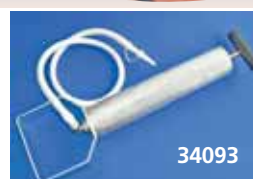

## VACUUM MATTRESS

### • 34089 MAT PLUS VACUUM MATTRESS

PVC, X-ray translucent mattress provided with 4 immobilization straps and 12 transport holes. Suitable for any kind of emergency situation. Size: 210x90 cm. Weight: 11.2 kg. Loading capacity: 150 kg. Supplied with nylon bag size 86x43x17 cm, pump not included.



34089



Nylon carrying bag included with all vacuum mattresses



34093

### • 34093 ALUMINIUM PUMP for vacuum mattress

Capacity: 0.75 l  
Supplied with hose and fitting. Rotating handle.

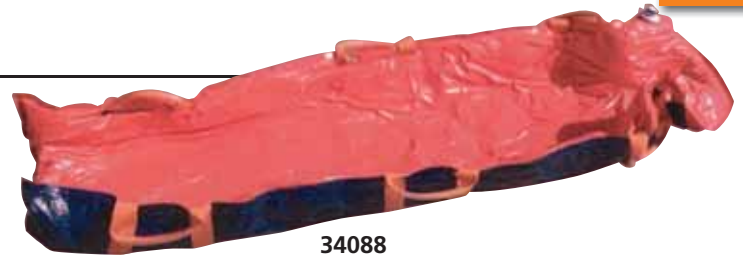

34088

### • 34088 MAT VACUUM MATTRESS

PVC, X-ray translucent mattress with 6 transport handles, perfectly fits the patient body. Sturdy material and careful manufacture make it suitable for Civil Defence, Fire Brigades, Industry and First-aid on the mountains. Size: 200x75 cm. Weight: 8.8 kg. Loading capacity: 150 kg. Supplied with nylon bag size 70x43x15 cm, pump not included.



34091

### • 34091 MAT ORANGE VACUUM MATTRESS

X-ray translucent, comfortable vacuum mattress with 8 transport handles and 4 immobilization straps. Size: 210x90 cm. Weight: 9 kg. Loading capacity: 150 kg. Supplied with nylon bag size 86x43x15 cm, pump not included.

## SEMIRIGID SPLINT KIT

### • 34119 SEMIRIGID SPLINT KIT

Kit of 3 splints (arm, wrist, leg) in nylon carrying bag. All splints are made of polyester + PVC, with lightweight stays providing high strength support. Adjustable velcro for easy use.



34119

## EXTRICATION KITS



34028

34027

Provide horizontal flexibility and vertical rigidity support

• 34027 SPINAL IMMOBILIZER TYPE A  
• 34028 SPINAL IMMOBILIZER TYPE B  
GIMA presents 2 different shape of spinal immobilizers, both are ideal for the immobilization and setting free of patients from emergency situations. They allow to fix vertically and horizontally the head and spine of the patient to limit any injuries caused by wrong transport. Supplied with different colour buckles and belt for easy use, padded cushion velcro straps and waterproof bag.

## BODY BAGS



### • 34116 BODY BAG - PVC

Made of PVC (Inner transparent PVC, over black), provided with two long slide fasteners. Colour: black. Size: 210x90 cm. Loading capacity: 150 kg.



### • 34117 BODY BAG - vinyl - blue

Made of vinyl covered nylon conform to standard EN 1865. Provided with a long slide fastener. Size: 210x90 cm. Loading capacity: 150 kg.



## CARRYING COT

Multilanguage manual:  
GB, FR, IT, ES,  
PT, DE

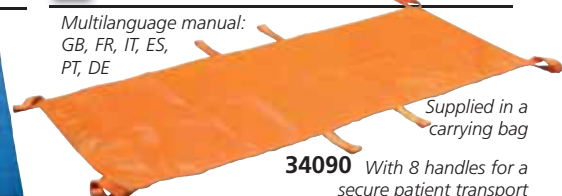

Supplied in a carrying bag

34090 With 8 handles for a secure patient transport

### • 34090 CARRYING COT

Made in polyester, PVC coated. Anti-putridity, bacterial and fungus proof, waterproof, easy to wash and disinfect, X-ray translucent material. Size 185x57 cm. Loading capacity: 150 kg. Certified EN1865-2010 + A1 2015

# GIMA STRETCHERS AND SPINAL BOARDS



• **34101 GIMA STRETCHER 2 - foldable in 2**  
Emergency stretcher is sturdy, but lightweight in construction, with aluminium frame and three solid iron cross-bars for heavy use. Reinforced nylon canvas, fluid repellent and non-tear.



34101

Supplied with carrying bag

• **34107 GIMA STRETCHER 4 - foldable in 4**  
Made of strong alloy and water-tight material. Light weight, easy to carry, foldable in 4. Length foldable in 2 parts, width foldable in 2 parts.



34107

• **34105 STACKABLE STRETCHER**  
Used in small rooms where it is necessary to store a large number of stretchers. PVC does not absorb blood or body fluids. Strong lightweight aluminium construction with vinyl coated polyester

• **34076 BLUE STRETCHER - foldable in 2**  
Light-weight, small sized, easy to carry. High-strength aluminium poles and vinyl coated waterproof nylon canvas.



34076

• **34077 WHEEL STRETCHER - foldable in 2**  
Wheels, outriggers and adjustable backrest. High strength aluminium poles and vinyl coated, waterproof nylon canvas. Light weight, small sized, easy to carry.



34077

• **34083 SPINAL BOARD**  
X-ray translucent, washable, buoyant and impervious to all fluids. Made in linear high density polyethylene with plastic pins. Compatible with all head-immobilization devices and strapping system. CT and MRI transparent. Colour orange.

• **34022 B-BAK PIN SPINAL BOARD - yellow**  
PE spinal board with Pin with robust and light structure to ensure high resistance. The 14 handles and their shape offer an easy grip, the low thickness make the application easier. Equipped with 8 plastic pins to allow easy fixing of belts with snap hook.

• **34097 SPINAL BOARD WITH SAFETY GLASS FIBRE PINS - orange**  
Strong and lightweight high density PE spinal board, with two fibre reinforced plastic stays. Provided with glass fibre pins for better fixation of immobilisation belts. Excellent in water rescues. X-ray translucent, except 2 plastic stays.



Glass fibre pins

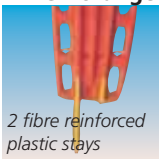

2 fibre reinforced plastic stays

• **34023 BABY GO PEDIATRIC SPINAL BOARD**  
Baby go is a professional board, designed for children, which maintains the spine in neutral position with the ideal alignment for air flow. Board has four different profiles which guarantee the correct position of the child according to his body size.



34023

The central tape can be used as a tape measure

• **34024 PEDIATRIC HEAD IMMOBILIZER**  
Ensure optimal immobilization of the head of children perfectly fitting their pronounced occipital prominence.

• **34025 PEDIATRIC SPIDER STRAP SYSTEM**

TECHNICAL SPECIFICATIONS	34101 GIMA 2	34107 GIMA 4	34105 STACKABLE	34076 BLUE	34077 WHEEL	34083 SPINAL	34022 SPINAL WITH PINS	34097 SPINAL WITH PINS	34023 PAED SPINAL
Open size cm:	203x50x14	221x53x16	188x48x18	188x45x7	188x53x21	184x44.5x6.5	184x40.5x4.5	183x46x5	119.5x32x4.5
Folded size cm:	96x50x17	104x19x12	-	94x48x10	92x53x12	-	-	-	-
Weight:	6 kg	5 kg	6 kg	4 kg	8 kg	7.6 kg	6 kg	7 kg	2.2 kg
Load:	120 kg	150 kg	170 kg	150 kg	150 kg	150 kg	180 kg	200 kg	30 kg

## SCOOPIING STRETCHER

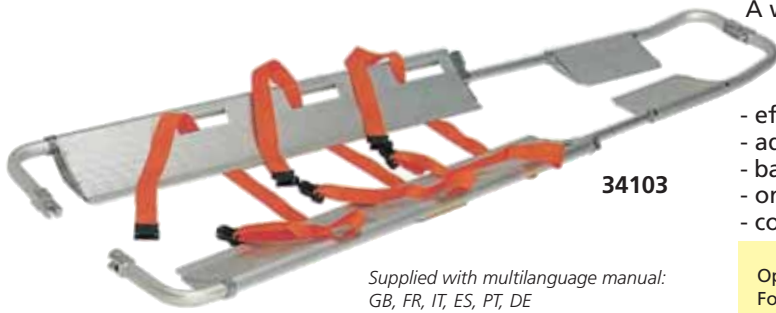

34103

Supplied with multilanguage manual:  
GB, FR, IT, ES, PT, DE

### • 34103 SCOOPIING STRETCHER

- A wonderfully practical scooping stretcher allows to put the stretcher under the patient without moving him/her much. The shape of the stretcher has been designed to immobilize the patient properly during transport.
- effective hooking and unhooking device for stretcher uncoupling
  - adjustable stretcher length with automatic locking device
  - bag with 3 quick unhooking safety belts for patient immobilization
  - once folded can be easily stored inside the ambulance
  - completely built in light and sturdy aluminium

#### TECHNICAL SPECIFICATIONS

Open size cm:	min 171x43	max 212x43
Folded size cm:	120x43	
Weight:	8 kg	
Load:	150 kg	

## HEAD IMMOBILIZERS

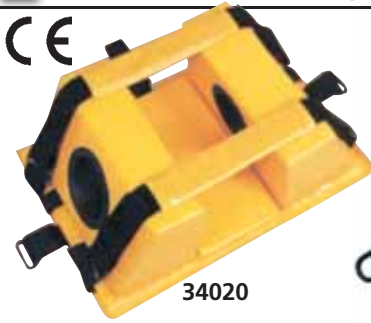

34020



34021



34078

34080

**HEAD IMMOBILIZERS**  
GIMA introduces four models of head immobilizers, different in shape, material and colour. All are composed of two head blocks and two straps to prevent any head movement of the injured person during transport. We can offer "STOP" head immobilizer in yellow, blue, red, green, military green for minimum 50 pieces.



34021



34079

Radiolucent material,  
suitable for x-ray chamber

GIMA code	Type	Colour	Material
34020	FERMO-1	yellow	PE foam covered with PVC
34021	FERMO-2	red	NBR foam dipped with PVC
34080	STOP	orange	High density foam+water repellent coating
34078	STOP	black	High density foam+water repellent coating
34079	CONTOUR	yellow	Moulded polyurethane and PVC

## IMMOBILISATION BELTS FOR STRETCHERS AND SPINAL BOARDS



34010



34011

Adjustable belt



34014

Set of 3 adjustable belts with pouch



34015

Set of 3 belts with pouch



34012



34013

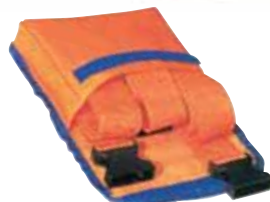

34081

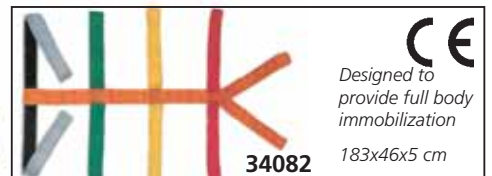

34082

Designed to provide full body immobilization  
183x46x5 cm

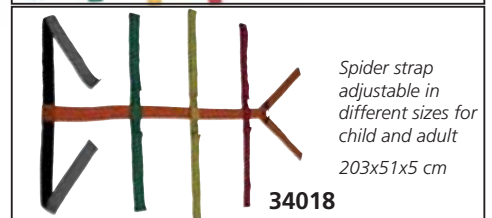

34018

Spider strap adjustable in different sizes for child and adult  
203x51x5 cm

GIMA code	Type	Colour	Size cm	Max load kg	Buckle style	To be used with
34010	Belt-A	red	5x213	60	plastic snap-lock	stretchers + boards
34011	Belt-B - adjust.	black	5x213	60	2 swivel speed clip + plastic snap-lock	spinal boards with pin
34012	Belt-C	red	5x213	200	automatic quick release (unique belt)	stretchers + boards
34013	Belt-D	black	5x213	200	automatic quick release (belt in 2 pcs.)	stretchers + boards
34014	Set 3 belt-B	orange	5x274	60	2 swivel speed clip + plastic snap-lock	spinal boards
34015	Set 3 belt-D	yellow	5x213	200	2 swivel speed clip (belt in 2 pcs.)	stretchers + boards
34081	Set 3 Belts	orange	-	-	quick release plastic hook	stretchers + boards
34082	Ragno/Spider	mix	5x46x183	-	velcro strapping system	spinal boards
34018	Adjustable spider	mix	5x51x203	-	velcro strapping system - adjustable	spinal boards
32794	Nylon bag	red	-	-	-	contains up to 3 belts

## AUTOMATIC LOADING STRETCHER



FDA 3005348775  
 CE  
 SGE

34055

### • 34055 AUTOMATIC LOADING STRETCHER

Automatic stretcher to load and unload patients from emergency vehicles, can be moved by only one person. Specially designed with roll-in system to easily load and unload patients from emergency vehicle without lifting them. Legs fold under cot automatically as stretcher is rolled into the vehicle. Lock-in operating position as cot is removed from vehicle, left-hand and right-hand control levers unlock front and back legs respectively so as to be folded when cot is loaded. Polyethylene covered legs allow cot to roll smoothly in and out of vehicle. Mattress, belts, side rails, IV stand and fixing devices are included.

#### TECHNICAL SPECIFICATIONS

Maximum size (LxWxH):	193x60x88 cm
Minimum size (LxWxH):	193x60x21 cm
Packing size:	195x61x26 cm
Weight:	40 kg
Load:	159 kg



## MULTIPOSITION STRETCHER



FDA 3005348775  
 CE  
 SGE

34056

### • 34056 MULTIPOSITION AUTO STRETCHER

Multifunctional automatic stretcher for ambulance with easily adjustable positioning system, for any emergency situation. The stretcher can bend through 6 different grades, forwards or backwards. The back of the stretcher is fixed by pneumatic springs moving in the range of 0 to 60 degrees, also equipped by front and back fixed supports. It can be locked into place inside ambulance at proper position. Mattress, belts, side rails, I.V. stand and fixing devices are included.



#### TECHNICAL SPECIFICATIONS

Maximum size (LxWxH):	198x53x93 cm
Minimum size (LxWxH):	198x53x34 cm
Packing size:	200x60x35 cm
Load:	159 kg
Net weight, Gross weight:	35 kg, 40 kg
Maximum angle of leaning forwards:	11 degrees
Maximum angle of leaning backwards:	25 degrees
The height scope of touching down (6 grades):	98 cm - 94 cm - 87 cm 77 cm - 60 cm - 34 cm

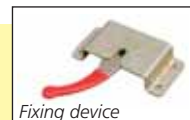

## AUTOMATIC MULTIPosition STRETCHER



FDA 3005348775  
 CE  
 SGE

34072

### • 34072 FULL AUTOMATIC MULTIPosition STRETCHER

Full automatic multiposition stretcher. Easily adjustable to 6 levels for any emergency situation. Back wards and forwards reclining, back and foot rest adjustable to different positions. Can be loaded into ambulance by one operator only and locked at desired position. Structure in high-strength aluminium alloy. Soft foam surface mattress, covered by special seamless welded PVC. Protective block side rust proof and easy to clean. Mattress, belt, side rails, IV stand and fixing device are included.

#### TECHNICAL SPECIFICATIONS

Maximum size (LxWxH):	198x54x93 cm
Minimum size (LxWxH):	198x54x30 cm
Packing size:	218x67x35 cm
Load:	159 kg
Net weight, Gross weight:	39 kg, 45 kg



## WHEELCHAIR STRETCHER



FDA 3005348775  
 CE  
 SGE

34070

### • 34070 WHEELCHAIR STRETCHER

Wheelchair stretcher with varied positions. Lightweight emergency cot quickly convert to any of four chair positions for maneuvering in narrow hallways, elevators and other confined spaces. Stretcher is made in high quality aluminium alloy. Soft foam mattress and protective block side, rust proof and easy to clean. Mattress, belts, side rails, IV stand and fixing device are included.

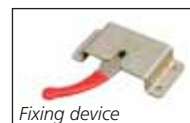

#### TECHNICAL SPECIFICATIONS

Size (LxWxH):	190x57x85 cm
Packing size:	198x60x25 cm
Load:	159 kg
Net weight, Gross weight:	32 kg, 40 kg



## BASKET STRETCHER

- 34094 TWIN SHELL BASKET STRETCHER - orange
- 34098 BASKET STRETCHER - orange

Robust, resistant and flexible, it is ideal for a wide range of rescue operations in mines, at altitude and in water. A revolutionary production technique ensures uniform thickness of the entire length of the stretcher. The shell is in high-density polyethylene and is joined to an aluminium framework for better strength. The handles for transport, integrated in the structure, are placed along the entire perimeter. The grommets for the fixing of the spring catches of the harnessing are in stainless steel. Inside the shell there is a removable mattress, applied with Velcro®, made in closed-cell EPDM, which makes it impermeable to both blood and water. High density polyethylene guarantees shatterproofness and sanitization. It can contain a spine board. Comes with nylon rope along entire perimeter, three 50 mm nylon belts with quick-release buckles, water resistant and closed-cell mattress, footrest in pre-formed polyethylene with position regulator.

### Twin shell basket stretcher

It can be transversally divided in half to improve the storage and transport. To ensure a perfect hold between the two shells, have been inserted four nylon cones and a security system protected by a protuberance placed in the mould itself.

### 34099 LIFTING BRIDLES

Adjustable, can be used for horizontal and vertical patient lifting. Manufactured in durable woven nylon with sound steel attachment hardware and brass locking mechanism.

### 34100 FLOTATION SYSTEM

### 34096 CARRYING BAG for 34094

**34098**

TECHNICAL SPECIFICATIONS		
	34098	34094
Size (LxWxH):	215x65x19 cm	118/215x64x19 cm
Load capacity:	280 kg	280 kg
Weight:	13.5 kg	17 kg

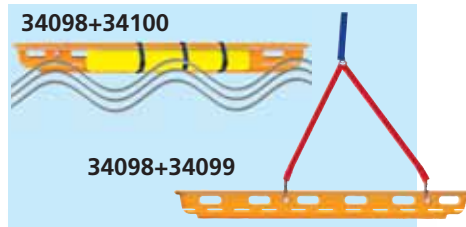

## WHEELCHAIR STRETCHERS

- 34060 WHEELCHAIR STRETCHER - 2 wheels
- 34074 WHEELCHAIR STRETCHER - 4 wheels

Specially designed for confined areas such as narrow hallways or multiple landing stairways; anywhere access is seriously limited. Made in light aluminium with waterproof orange sheet. Two rear stationary wheels Ø 12 cm (34060) or 4 wheels, 2 with brake (34074) two back handles and four front handles, 2 adjustable 30 cm, facilitate transport on most floor types. 2 quick lock safety belts immobilize patient during transport. Locking safety latch maintains chair position during use.

TECHNICAL SPECIFICATIONS		
Folded size:	91x52x19.5 cm	Open size: 91x52x71 cm
Wheelchair size:	- back height: 91 cm - width: 52 cm	- seat height: 48 cm - width: 52 cm
Loading:	150 kg	Weight: 8.5 kg

Foldable down handle

Foldable up handle



34060



34074

Adjustable handle (+30 cm)

## FOLDING STAIR CHAIR AND EVACUATION CHAIR

- 34058 EVACUATION CHAIR - orange/chrome
- 34059 FOLDING CHAIR - black/yellow (orange/chrome on request)
- 34061 SKID EVACUATION CHAIR - with braking slide

Designed and built for emergency patient removal from confined spaces. Folded it can be stored in most ambulances. Manufactured from chromed steel with brakes on the front wheels.

Seat cover made of vinyl coated nylon, easily washable. Folds in one movement, equipped with two quick-release patient restraints.

- 34059 FOLDING CHAIR - black/yellow (orange/chrome on request)

A cost effective choice for moving patients through difficult situations. Four non-slip grip handles make lifting the patient safer and easier. Two large rear wheels provide easy manoeuvring. Tough, black, vinyl coated seat cover easy to clean, resists stain and provides bacteriostatic protection. Supplied with a set of 3 plastic buckle belts. Made in Italy

- 34061 SKID EVACUATION CHAIR - with braking slide

Skid-OK a new ultra compact evacuation chair with innovative aluminium frame and tubular trellis swing fork.

New concept materials and components make the chair lightweight and easy to manoeuvre to offer top performance in any scenario. Reclining armrests to increase patient comfort. The innovative self braking slide system offers the operator total control during the stair descent. Manufactured in welded aluminium with polished finish.

Adjustable seat strengthened with Spentex®.

Skid-OK is supplied with 2x50 mm polypropylene belts. Made in Italy.

	TECHNICAL SPECIFICATIONS		
	34059 FOLDING	34058 EVACUATION	34061 SKID
Height (open/closed):	92 cm	98/78 cm	154/104 cm
Width:	48 cm	41 cm	52 cm
Depth with retracted handles:	59 cm	-	-
Depth with extended handles:	125 cm	open 80 cm	-
Depth when folded handles:	19 cm	closed 31 cm	-
Weight:	10 kg	12 kg	11 kg
Load:	165 kg	116 kg	150 kg



34058

Height open/closed 154/104 cm

Pivoting front wheels

34061



34059

## SMART OXYGEN CONCENTRATOR

- **34598 SMART OXYGEN CONCENTRATOR 5 l**  
Medical grade, ultra quiet, small oxygen concentrator for home use. Provide high concentration of oxygen through nasal cannula. Work continuously.
- **34599 PAPER FILTER - box of 10**
- **34608 HUMIDIFIER BOTTLE**
- **34167 OXYGEN MASK with tube - pediatric**
- **34166 OXYGEN MASK with tube - adult**
- **34172 OXY GLASSES - nasal cannulas**

TECHNICAL SPECIFICATIONS	
Flow range:	0.5 ~ 5 l/min
Oxygen concentration:	95.5-87 %
Output pressure:	40 ~ 70 kPa
Input power:	400 W
Operation noise level:	≤ 48 dB (front) - ≤52 dB (whole unit)
Size - weight:	39x24xh 50 cm - 16 kg
Operating voltage:	230 V - 50 Hz (110 V - 60 Hz on request)

Supplied with filter and nebulizer set



## OXYGEN CONCENTRATORS 3 AND 5 LITRES

- **34604 OXYGEN CONCENTRATOR 3 l**
- **34605 OXYGEN CONCENTRATOR 5 l - with nebulizing function**  
Bionic and streamlined fashion design, which won the national outlook top award-Red Star Award. Low noise achieved by using advanced round airway and multi-level noise decreasing design. Large LCD screen for clearer figures. Cumulative time metering and timing off function. Fault self-detection system.

- Four alarm functions:
- power failure alarm
  - low oxygen concentration alarm
  - pressure cycle failure alarm
  - compressor failure alarm

### Nebulizing function (only 34605)

Oxygen concentrator (with nebulizer function) uses the combination of oxygen uptake and atomization function to offer clean and safe air. It assists in atomized treatment while maintaining the same oxygen concentration.

- **34607 PAPER FILTER - box of 10 (5 internal + 5 external)**
- **34608 HUMIDIFIER BOTTLE**
- **34172 OXY GLASSES - nasal cannulas**
- **34167 OXYGEN MASK with tube - pediatric**

CE 0123

**yuwell**  
Top manufacturer  
over 200,000 pcs/years



Supplied with filter, nasal oxygen cannula, nebulizer set (34605 only) and manual (GB, IT)

TECHNICAL SPECIFICATIONS		
	34604	34605
Flow range:	0.5 ~ 3 l/min	0.5 ~ 5 l/min
Oxygen concentration:	93% ± 3%	95.5% ~ 87%
Output pressure:	20 ~ 50 kPa	40 ~ 70 kPa
Operation noise level:	≤ 50 dB (A)	≤ 53 dB (A)
Input power:	320VA	400VA
Net/gross weight:	25/27 kg	
Packing size:	62x37xh 71 cm	
Operating voltage:	230 V - 50 Hz (on request 110 V - 60 Hz)	

## OXYGEN CONCENTRATOR 3 AND 5 L DELUXE

- **34616 OXYGEN CONCENTRATOR 3 l DELUXE**
- **34617 OXYGEN CONCENTRATOR 5 l DELUXE**  
Top of the range oxygen concentrator with innovative design and superior features:
- backlit LCD screen with adjustable brightness
- built-in oximeter for monitoring SpO<sub>2</sub> in real time
- oil free pump: the heart of concentrator adopt compressor with German technology for 30,000 hours service life and 5 years warranty
- high intake position, cleaner air
- remote control function
- 4 alarm system (low oxygen concentrator alarm, power outage alarm, pressure cycle failure alarm, compressor failure alarm), self detection of fault
- 4 safety protections
- **34618 PAPER FILTER - box of 10**
- **34619 HUMIDIFIER BOTTLE**
- **34166 OXYGEN MASK with tube - adult**
- **34167 OXYGEN MASK with tube - pediatric**
- **34172 OXY GLASSES - nasal cannulas**

Manual: GB, IT.

**yuwell**

Backlit LCD screen with adjustable light

CE 0123

Nebulizer function

Built-in oximeter for real time detection

Supplied with filter, nasal oxygen cannula, nebulizer set, remote control and manual (GB, IT)

Remote control

Compact and lightweight only 17.5 kg



TECHNICAL SPECIFICATIONS		
	34616	34617
Flow range:	0.5 ~ 3 l/min	1 ~ 5 l/min
Oxygen concentration:	93% ± 3 %	87-95.5 %
Operation noise level:	≤ 46 dB(A)	≤ 49.5-52 dB(A)
Output pressure:	20 ~ 50 kPa	40 ~ 70 kPa
Input power:	320VA	400VA
Size - Packing size:	50x21xh 64 cm - 56x32xh 71.5 cm	
Operating voltage:	230 V - 50 Hz (110 V - 60 Hz on request)	



# OXYGEN CYLINDERS: 0.5, 2, 3, 5 AND 7 LITRES



**CYLINDERS FOR OXYGEN THERAPY (empty)**  
 Steel cylinders for therapeutic oxygen at 200 bar pressure, with valve and safety lock. These cylinders are ideal for home and hospital therapeutic use, particularly in case of desultory oxygen supply. Supplied in a sturdy plastic bag (5 and 7 l) or soft bag (2 and 3 l) with cover. Oxygen cylinders are provided with a pressure reducer with two-stage release valve (0-15 l/min) and high pressure manometer to indicate oxygen quantity in the cylinder (Code 34510/34511) and face mask (excluding 34500/34520).

GIMA code		OXYGEN CYLINDERS WITH INTEGRATED PRESSURE REDUCER				
UNI	NF	Litres	Flow	Size	Weight kg	
34500	34520*	0.5	fixed 6 l	Ø 60x400mm	2.75	-
34502	34522*	2	0/15 l	Ø110x410mm	4.5	with soft bag + cover
34503	34523*	3	0/15 l	Ø110x530mm	5.5	with soft bag + cover
34505	34525*	5	0/15 l	Ø140x550mm	9	with plastic bag + cover
34507	34527*	7	0/15 l	Ø140x680mm	11	with plastic bag + cover

**PRESSURE REDUCER with valve** 9 steps for flow adjustment  
 Pressure reducer with valve and index flowmeter adjustable 0-12 l/min, suitable for cylinders 1 to 3 litres (code 34510/34530) and 5 to 7 litres (34511/34531). It includes two stages, release valve and high pressure manometer. Thread cylinder connection: E25/E17 conical refill thread connection  
 UNI 21.7 x 1/14" or NF Ø 22.91 x 1.514 **34510**  
 Apparatus to be connected to a cylinder without valve.



Oxygen therapy masks are produced with non toxic material, complete with adjustable elastic clip for nose and connecting tube **CE 0086**



UNI	NF	PRESSURE REDUCERS WITH VALVE - spare
34510	34530*	Integrated pressure reducer with valve for 2/3 litres
34511	34531*	Integrated pressure reducer with valve for 5/7 litres
34539		Cover protection for cylinders 2/3/5/7 litres

GIMA code		OXYGEN THERAPY MASKS
34166		Oxygen therapy mask - adult - with tube
34167		Oxygen therapy mask - paediatric - with tube
34168		HI-Oxygen therapy mask - adult - with tube
34169		HI-Oxygen therapy mask - paediatric - with tube
34276		Disposable oxy tube - 2m - female - female
34172		Oxy glasses - nasal cannulas

\*Products not in stock, available in 15 days

# GENERAL PURPOSE CYLINDERS 5 AND 10 l AND PRESSURE REDUCERS



**GENERAL PURPOSE CYLINDERS (empty)**  
 Supplied with valve. Ideal for anaesthesia apparatus, can be used with pressure reducer code 34540-34541 or other standards (NF, DIN, BRITISH STD or PIN INDEX).

GIMA code					OXYGEN CYLINDER WITH VALVE AND ACCESSORIES
UNI	NF	DIN	BULL NOSE BRITISH STD	PIN INDEX	
34545	34555*	34565*	34575*	34585*	Oxygen Cylinder 5 l with valve
34548	34558*	34568*	34578*	34588*	Oxygen Cylinder 10 l with valve
34540	34550*	34560*	34570*	34580*	Pressure reducer
34541	34551*	34561*	34571*	34581*	Pressure reducer with flowmeter and humidifier
34590	34590	34590	34590	34590	Humidifier autoclavable at 121°C

\*Products not in stock, available in 15 days

**PRESSURE REDUCER (34540, 34550, 34560, 34570, 34580)**  
 Same as code 34541, with adjustable flow 0-15 l/m in 9 steps (1/1.5/2/3/4/6/9/12/15), LP\* port, without flowmeter and humidifier.

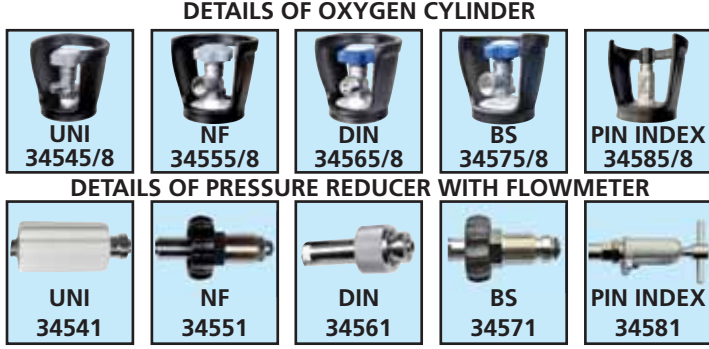

**PRESSURE REDUCER - WITH FLOWMETER AND HUMIDIFIER (34541, 34551, 34561, 34571, 34581)**  
 Pressure reducer with release valve and H.P. manometer with adjustable ball flowmeter 0-15 l/min and autoclavable humidifier apparatus to be connected with cylinder valve.



- 34590 AUTOCLAVABLE HUMIDIFIER
- 34177 TROLLEY FOR OXYGEN CYLINDER - 5 l - 7 l
- 34178 TROLLEY FOR OXYGEN CYLINDER - 10 l

\*Low pressure port (for ventilators,...)

## AMBU® MARK IV RESUSCITATORS



- 34200 AMBU® MARK IV RESUSCITATOR - adult**  
 Designed in accordance with the original double wall principle, the new 100% latex-free Ambu bags are more robust and provide users with exceptional visual and tactile lung condition feedback during manual resuscitation, making operation safer and more secure. Built-in pressure limitation prevents compression if there is any resistance in the patient's airways. Suitable for adults and children over 15 kg (3 years). Supplied with face mask N°5 and single shutter valve. Autoclavable at 134°C. Maximum volume 1300 ml.
- 34204 AMBU® MARK IV RESUSCITATOR - baby**  
 Same as 34200, but suitable for neonates, infants and children up to 20 kg (approx 4-5 years). Supplied with face mask N°0A, oxygen reservoir tube 250 mm and pressure limiting valve 4.0 kPa (40 cm H<sub>2</sub>O). Maximum volume 300 ml.
- 34217 AMBU MARK® IV RESUSCITATOR - adult with kit bag**  
 Same as code 34200, supplied with helicoidal mouth-wedge, tongue holding forceps, 3 Guedel airways (small, medium and large) and oxygen tube, all fitted in a resistant nylon bag.

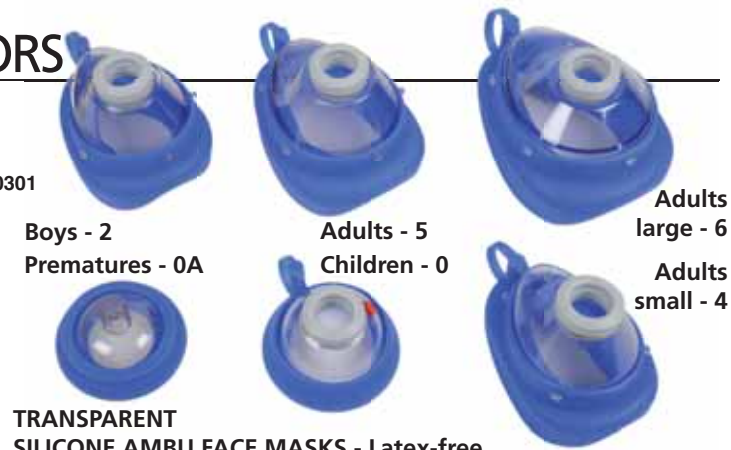

**TRANSPARENT SILICONE AMBU FACE MASKS - Latex-free**  
 The silicone face masks are self-inflating and the cuff pressure can be regulated for an easy and efficient seal. They are comfortable to grip and feature a thumb rest so rescuers can achieve a tight seal. Visual checks of bleeding, vomitus and spontaneous breathing can be made through the transparent dome. Autoclavable at 134°C

GIMA code	AMBU TRANSPARENT LATEX-FREE FACE MASKS AND RESERVOIR
34210	Ambu Baby N° 0A - newborns/prematures - blue
34205	Ambu Baby N° 0 - newborns/children - blue
34206	Ambu N° 2 - boys - blue
34207	Ambu N° 3/4 - adults/small - blue
34208	Ambu N° 5 - adults - blue
34209	Ambu N° 6 - adults/large - blue
34215	Reservoir bag 1500 ml - adult



## GIMA RESUSCITATORS - DOUBLE CHAMBER, WITH QUALITY MASK

**GIMA RESUSCITATOR BAG - with double chamber**  
 Highly professional resuscitator bag with an antistatic autoclavable and self expanding rubber internal bag and with extra soft external bag.  
 Available in 2 models: adult and infant.  
 All models are equipped with connections in accordance with EN 1281-1 directives for peep valve, intubation fitting, oxygen reservoir, oxygen intake and face masks.  
 Radiotransparent and latex free  
 All equipped with removable and autoclavable valve.  
 Made in Italy.

- 34240 RESUSCITATOR BAG - adult**  
 Supplied with facemask N° 4 - volume 1900 cc
- 34241 RESUSCITATOR BAG - with kit bag**  
 Same as 34240 supplied with helicoidal mouth-wedge, tongue holding forceps, 3 Guedel airways (small, medium and large) and oxygen tube, all fitted in a resistant nylon bag.



- 34242 RESUSCITATOR BAG - infant**  
 Supplied with facemask N° 2 - volume 400 cc  
 321



## GIMA RESUSCITATORS WITH DOUBLE STAGE VALVE



**34231**  
Resuscitator with kit bag and facemask N° 4

### GIMA RESUSCITATOR BAGS

The line offers 3 models of different size: adults, children, infants and an adult kit. All models are supplied with pressure relief valve and equipped with connector under EN 1281-1 directive for: peep valve, intubation fitting, reservoir, oxygen intake, face mask. Each resuscitator can be completely disassembled for cleaning and sterilization. Made in Italy. Autoclavable at 121°C max 20 times.

- **34230 RESUSCITATOR BAG - with mask N°4 - adult**  
With a special double stage valve at 54 m/bar. Volume 1800 cc.
- **34233 RESUSCITATOR BAG - with mask N°3 child**  
With a special double stage valve at 54 m/bar. Volume 800 cc.
- **34232 RESUSCITATOR BAG - with mask N°2 - infant/newborn**  
With a special double stage valve at 54 m/bar. Volume 400 cc.
- **34231 RESUSCITATOR BAG - adult with kit bag**  
Same characteristic as code 34230. It is supplied with helicoidal mouth-wedge, tongue holding forceps, 3 Guedel airways (small, medium and large) oxygen tube, in a nylon bag.
- **34271 NYLON BAG - 18.5x15xh 30 cm - spare**

Double side overpressure valve at 54 m/bar avoids inconvenients in case of a regurgitation due to the presence of food in the stomach of the patient

Size 330 x Ø120 mm  
Capacity = 1,800 cc

CE



34232 Pediatric resuscitator with child facemask N° 2

Size 235xØ 78 mm  
Capacity=400 cc

CE



**34230**

## SILICONE TRANSPARENT AUTOCLAVABLE RESUSCITATORS

### SILICONE RESUSCITATORS - latex free

Transparent resuscitators made of silicone and polysulfone fully autoclavable at 134°C.

- **34244 SILICONE RESUSCITATOR KIT - adult**  
Supplied with silicone face mask N° 4, 60 cm H<sub>2</sub>O pop-off valve, oxygen tube 2 metres, autoclavable reservoir valve and 2500 ml reservoir bag. Volume: 1,600 ml.
  - **34245 SILICONE RESUSCITATOR - adult**  
Supplied with silicone face mask N° 4. Volume: 1600 ml.
  - **34246 SILICONE RESUSCITATOR - child**  
Supplied with silicone face mask N° 3 and 40 cm H<sub>2</sub>O pop-off valve. Volume: 500 ml.
  - **34247 SILICONE RESUSCITATOR - infant**  
Supplied with silicone face mask N° 1 and 40 cm H<sub>2</sub>O pop-off valve. Volume: 280 ml.
- All silicone resuscitator have multilanguage manual: GB, FR, IT, ES, PT



**34245**

Intake valve

CE 0476

All resuscitators are LATEX FREE



CE 0476

**34244**



CE 0476

**34246**



CE 0476

**34247**

- **34243 SILICONE RESUSCITATOR BAG KIT - adult**  
Supplied with silicone face mask N° 4, 60 cm H<sub>2</sub>O pop-off valve, oxygen tube 2 metres, autoclavable reservoir valve and 2,500 ml reservoir bag (volume: 1,600 ml), helicoidal mouth wedge (34273), tongue holding forceps, 10 Guedel airways (34439) with Cubo emergency bag (27163).



**34243**

## AMBU® SPUR II RESUSCITATOR - THE NEXT GENERATION

### AMBU SPUR II RESUSCITATOR - single patient

Ambu SPUR II provides users with exceptional tactile and visual feedback during resuscitation. The bag is highly responsive, with minimal mechanical resistance. Furthermore the characteristic design provides optimum stroke volume with perfect recoil. Range includes infant, pediatric, and adult sizes. All Ambu SPUR II resuscitators come in individual, resealable plastic carrying bags, complete with mask, reservoir bag (34235, 34236 only) oxygen tube and pressure limiting valve 4.0 kPa H<sub>2</sub>O (34236/7 only). The bags are color-coded for fast identification of infant, pediatric, and adult sizes.

- 34235 AMBU SPUR II ADULT - with face mask n° 5 and reservoir bag
- 34236 AMBU SPUR II PEDIATRIC - with face mask n°1 and reservoir bag
- 34237 AMBU SPUR II INFANT - with face mask n° 0

	TECHNICAL SPECIFICATIONS		
	34235	34236	34237
Suitable for	adult > 30 kg	baby 10 to 30 kg	infant < 10 kg
Stroke volume	1 hand	800 ml	450 ml
	2 hand	1,000 ml	150 ml
Resuscitator volume	1,475 ml	635 ml	220 ml
Size (Length x diameter)	295x127 mm	234x99 mm	168x71 mm
Bag reservoir volume	2600 ml	1500 ml	-

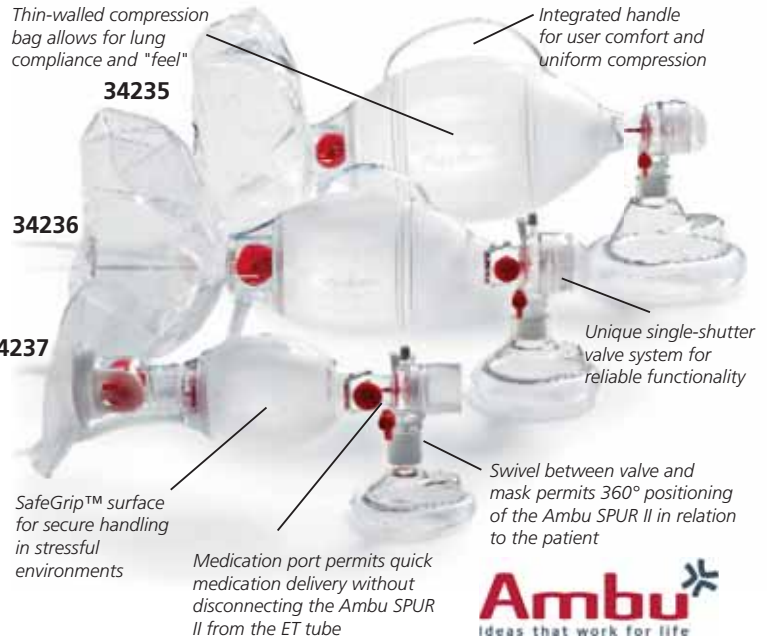

## RESUSCITATOR BAGS SINGLE-USE, SINGLE PATIENT - LATEX FREE

### PVC RESUSCITATORS - SINGLE PATIENT USE

Disposable resuscitator bags with disposable mask, no return membrane valve and connection for PEEP valve.

PVC disposable, transparent mask shaped to allow a perfect adhesion to the patient's face. Latex free.

- 34277 PVC RESUSCITATOR - adult  
Supplied with single use mask N° 5. Volume: 1,600 ml



- 34248 PVC RESUSCITATOR - child  
Supplied with single use mask N° 3 and 40 cm H<sub>2</sub>O pop-off valve. Volume: 500 ml

- 34249 PVC RESUSCITATOR - infant  
Supplied with single use mask N° 1 and 40 cm H<sub>2</sub>O Pop-off valve - Volume: 280 ml

- 34239 PVC RESUSCITATOR KIT - adult  
Same as code 34277. Supplied with oxygen reservoir 2,500 ml, tongue holding forceps and oxygen tube in a nylon bag.



## GUEDEL AIRWAYS

### STERILE AND NON STERILE GUEDEL AIRWAYS

Guedel airways in 9 sizes with smooth surface and round tip for improved patient comfort.

Made in polyethylene (PE). Latex free.

GIMA code	GUEDEL AIRWAYS - STERILE FLEXIBLE, TRANSPARENT, INDIVIDUALLY PACKED GUEDEL AIRWAYS	Minimum order
34431●	Guedel airway 40 mm - pink - newborn - 000	box of 10
34432●	Guedel airway 50 mm - blue - newborn - 00	box of 10
34433●	Guedel airway 60 mm - black - child - 0	box of 10
34434▲	Guedel airway 70 mm - white - boy - 1	box of 10
34435▲	Guedel airway 80 mm - green - adult/small - 2	box of 10
34436●	Guedel airway 90 mm - yellow - adult/small - 3	box of 10
34437●	Guedel airway 100 mm - red - adult/medium - 4	box of 10
34438●	Guedel airway 110 mm - orange - adult/large - 5	box of 10
34383	Guedel airway 120 mm - purple - adult/x-large	box of 10
34439	Mixed Guedel airways pack of 1 pcs. of ● marked and 2 pcs of ▲ marked airways for a total of 10 pcs.	



GIMA code	GUEDEL AIRWAYS - NON STERILE FLEXIBLE, TRANSPARENT,	Minimum order
57751	Guedel airway 40 mm - pink - newborn - 000	box of 50
57752	Guedel airway 50 mm - blue - newborn - 00	box of 50
57753	Guedel airway 60 mm - black - child - 0	box of 50
57754	Guedel airway 70 mm - white - boy - 1	box of 50
57755	Guedel airway 80 mm - green - adult/small - 2	box of 50
57756	Guedel airway 90 mm - yellow - adult/small - 3	box of 50
57757	Guedel airway 100 mm - red - adult/medium - 4	box of 50
57758	Guedel airway 110 mm - orange - adult/large - 5	box of 50

# SILICONE AUTOCLAVABLE AND SINGLE USE FACEMASKS

**GIMA AUTOCLAVABLE FACE MASKS**  
Made in silicone and polycarbonate (sizes 3, 4, and 5) or all in silicone (sizes 0, 1 and 2). Completely transparent, allowing a total visibility. They can be used with any resuscitator and lung ventilator.

**AUTOCLAVABLE UP TO 40 TIMES**



GIMA code	SILICONE FACE MASKS LATEX FREE
34220	Facemask N° 0 - infant small
34221	Facemask N° 1 - infant large
34222	Facemask N° 2 - child small
34223	Facemask N° 3 - child large
34224	Facemask N° 4 - adults small
34225	Facemask N° 5 - adults large

**GIMA PLUS AUTOCLAVABLE FACE MASKS - ANAESTHESIA MASKS**  
Blue silicone inflating cuff and unbreakable transparent polysulfone hood. They can be used with any resuscitator or lung ventilator. Available in 5 sizes. Latex free.

**AUTOCLAVABLE UP TO 120 TIMES**



GIMA code	GIMA PLUS FACE MASKS LATEX FREE
34252	Face mask N°2 - child small
34253	Face mask N°3 - child large
34254	Face mask N°4 - adult small
34255	Face mask N°5 - adult large
34250	Face mask N°6 - adult extra large

**HIGH QUALITY**

**INFLATABLE AIR CUSHION FACE MASKS - ANAESTHESIA MASKS**  
Quality disposable single patient face masks provided of connector for air inflation and hook. Available in 7 sizes.

**CE 0434 SINGLE PATIENT**

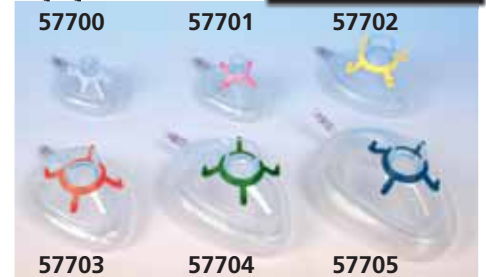

GIMA code	GIMA SINGLE PATIENT FACE MASKS LATEX FREE
57700	Facemask N° 0 - newborn - white
57701	Facemask N° 1 - infant - pink
57702	Facemask N° 2 - child - yellow
57703	Facemask N° 3 - child large - red
57704	Facemask N° 4 - adult - green
57705	Facemask N° 5 - adult large - blue
57706	Facemask N° 6 - adult extra large

# OXYGEN RESERVOIRS, VALVES AND ACCESSORIES

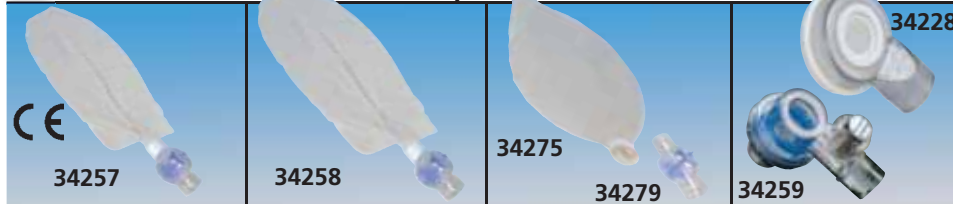

GIMA code	OXYGEN RESERVOIR - OXYGEN TUBE	To be used with GIMA codes
34275	SINGLE USE OXYGEN RESERVOIR - 2,500 ml - without valve	34244 - 34245 - 34277 - 34200 (need valve 34279), AMBU, LAERDAL 34275
34279	RESERVOIR VALVE - autoclavable	34246 - 34247 - 34248 - 34249
34257	SINGLE USE OXYGEN RESERVOIR - 1,000 ml - with valve	34244 - 34245 - 34277
34258	SINGLE USE OXYGEN RESERVOIR - 2,500 ml - with valve	All resuscitators
34276	OXYGEN TUBE - 2 m	34244 - 34245 - 34277
34259	NON-REBREATHING VALVE with 60 cm H <sub>2</sub> O Pop-off - autoclav.	34244-5 - 34277 (need 34228)
34227	PEEP VALVE - 30 mm (5-20 cm H <sub>2</sub> O) autoclavable at 121°C/248°F	34230 - 34240 - 34200
34228	PEEP VALVE ADAPTOR - int. Ø 22 mm, ext. Ø 30 mm	34227 - 34248 - 34249
34256	REAR VALVE (intake valve)	34244 - 34245 - 34246 - 34247

# ULTRA FACE MASKS

**ULTRA ANAESTHESIA - FACE MASKS**  
Disposable single patient face masks. Anti-slip design and anatomical shape for a precise fit. Excellent visibility, soft and comfortable seal. Provided with hook. Medical grade non-PVC, phthalate free.



GIMA code	ULTRA SINGLE PATIENT FACE MASKS LATEX FREE - box of 50	Suitable for kg
57711	Facemask N° 1 - infant - pink	2-10
57712	Facemask N° 2 - child - yellow	10-25
57713	Facemask N° 3 - adult S - green	25-60
57714	Facemask N° 4 - adult M - red	60-110
57715	Facemask N° 5 - adult L - blue	>110

# MOUTH OPENERS AND TONGUE HOLDING



- 34272 HELICOIDAL MOUTH OPENER PINOCCHIO
- 34273 TEETH SCREW DRIVER
- 34274 TONGUE HOLDING FORCEPS

# NYLON BAG

• 34271 NYLON BAG  
Suitable for all resuscitators

# STERILE CUFFED AND UNCUFFED ENDOTRACHEAL TUBES

GIMA code	UNCUFFED ENDOTRACHEAL TUBES - STERILE	Minimum order	GIMA code	CUFFED ENDOTRACHEAL TUBES - STERILE	Minimum order
34385	Uncuffed Endotracheal tube Ø 3 mm - 16.5 cm	box of 10	34387	Cuffed Endotracheal tube Ø 3.5 mm - 18.5 cm	box of 10
34386	Uncuffed Endotracheal tube Ø 4 mm - 21 cm	box of 10	34388	Cuffed Endotracheal tube Ø 5 mm - 24.5 cm	box of 10
			34389	Cuffed Endotracheal tube Ø 6 mm - 28.5 cm	box of 10
			34390	Cuffed Endotracheal tube Ø 6.5 mm - 29.5 cm	box of 10
			34391	Cuffed Endotracheal tube Ø 7 mm - 31 cm	box of 10
			34392	Cuffed Endotracheal tube Ø 7.5 mm - 31.5 cm	box of 10
			34393	Cuffed Endotracheal tube Ø 8 mm - 33 cm	box of 10
			34394	Cuffed Endotracheal tube Ø 8.5 mm - 33 cm	box of 10
			34395	Cuffed Endotracheal tube Ø 9 mm - 33 cm	box of 10
			34396	Cuffed Endotracheal tube Ø 10 mm - 33 cm	box of 10

Ø: Internal diameter

# LARYNGEAL MASKS FOR SAFE AND EASY INTUBATION

## SILICONE REUSABLE LARYNGEAL AIRWAY MASK

1. Optimal anatomical design ensure convenient and safe insertion. Universal 15 mm connector (ISO).
2. See-through flexible airway tube, clear guideline for easy insertion.
3. Tiny protruding bumps minimize the vomiting substance flowing from exophagus and into the lung.
4. Seamless cuff formation offers maximum comfort.
5. Strengthened oval tip prevents possible bending during insertion.
6. Thin walled pilot balloon facilitates the sensing of the inflation tube.



Each laryngeal airway mask is individually serialized for identification and traceability purposes

GIMA code	Size	Patient range	Weight range	Cuff volume (ml. of air)
34424	1.5	infant	5-10 kg	7 ml
34425	2	infant	10-20 kg	10 ml
34426	2.5	child	20-30 kg	14 ml
34427	3	boy	30-50 kg	20 ml
34428	4	adult	50-70 kg	30 ml
34429	5	adult	>70 kg	40 ml

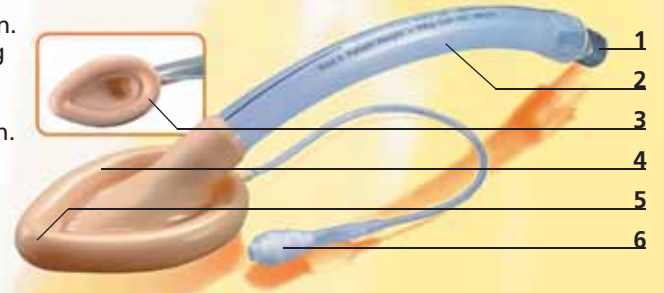

**AUTOCLAVABLE UP TO 40 TIMES**

# AMBU® AURAONCE™ DISPOSABLE LARYNGEAL MASK

## AMBU® AURAONCE™ DISPOSABLE LARYNGEAL MASKS

AuraOnce has a special curve that carefully replicates natural human anatomy. Molded directly into the tube, the unique shape makes correct insertion easy without abrading the upper airway. AuraOnce's curve also ensures that the patient's head remains in a natural supine position when the mask is in use without extra stress on the upper jaw. Moreover, Auraonce is specially designed to give the airway tube the flexibility needed to adapt to individual anatomical variances and wide range of head positions. AuraOnce has a D-shaped airway tube to give a firm and ergonomic grip during insertion. In short, positioning is fast and accurate, with least possible internal pressure.

- Packaged sterile and ready for use
- Colour coded pouch with directions for use
- Available in 5 sizes fitting a wide range of patients.



Cuff and airway tube moulded as single unit with built-in, anatomically correct curve

The airway tube is flexible at the cuff and rigid at the connector for easy, atraumatic insertion and removal

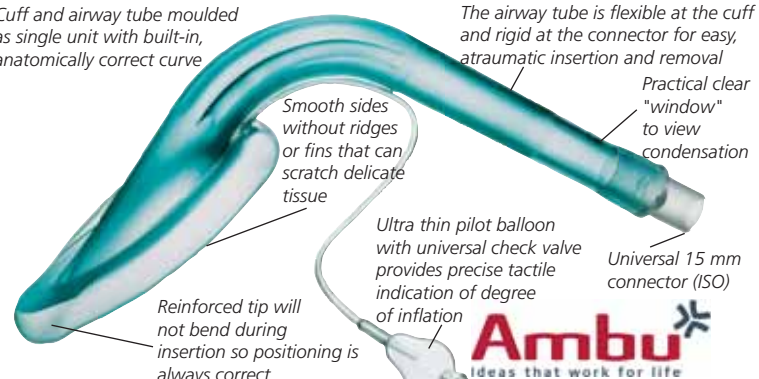

GIMA code	AMBU® AURAONCE™	Patient weight	Maximum cuff inflation volume
34406	Laryngeal Mask N 2 - pink	10-20 kg	10 ml
34407	Laryngeal Mask N 2.5 - pink	20-30 kg	14 ml
34408	Laryngeal Mask N 3 - green	30-50 kg	20 ml
34409	Laryngeal Mask N 4 - yellow	50-70kg	30 ml
34410	Laryngeal Mask N 5 - blue	70-100 kg	40 ml

# AMBU® AURA-i™ LARYNGEAL MASK VENTILATION & INTUBATION

## AMBU® AURA-i™ DISPOSABLE LARYNGEAL MASKS

Ambu® Aura-i™ is a disposable laryngeal mask designed for everyday use. Pre-formed to follow the anatomy of the human airway, the soft rounded curves of the Aura-i ensures fast and easy placement and guarantees long-term performance. Aura-i is the preferred everyday routine device for establishing an airway where an ET-tube is deemed unnecessary. At the same time it holds a place on the difficult airway cart. In case of a "Cannot Intubate - Cannot mask Ventilate" (CI-CV) situation, where the purpose is to intubate the patient, Aura-i can be used as conduit for direct endotracheal intubation assisted by a flexible scope.

The airway tube is designed to allow easy passage of an appropriately sized ET-tube. The recommended ET-tube size is indicated on the connector block of the mask. Aura-i comes in a complete range of 5 sizes, suitable for pediatrics and adults.

- packaged sterile and ready for use
- colour coded pouch with directions for use
- available in 5 sizes fitting a wide range of patients.

Direct endotracheal intubation using a flexible scope and standard ET-tubes



Built-in, anatomically correct curve for fast and easy insertion

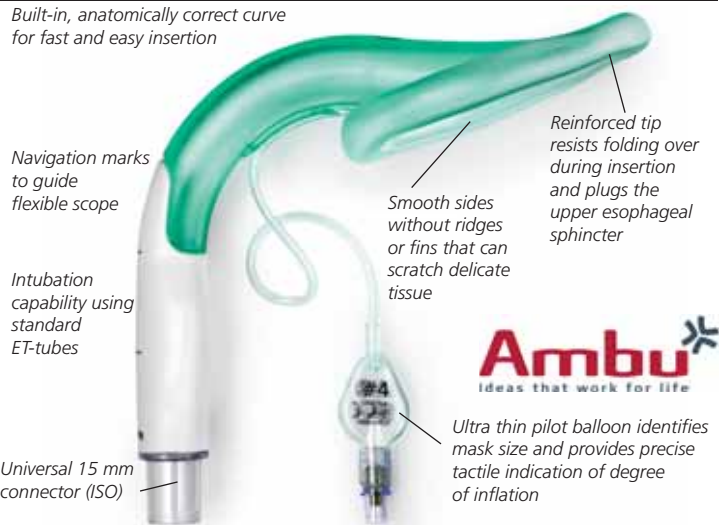

GIMA code	AMBU® AURA-i™	Patient weight	Maximum cuff inflation volume	Mask ET-Tubes
34593	Laryngeal Mask N 2 - pink	10-20 kg	10 ml	5.0
34594	Laryngeal Mask N 2.5 - violet	20-30 kg	14 ml	5.5
34595	Laryngeal Mask N 3 - green	30-50 kg	20 ml	6.5
34596	Laryngeal Mask N 4 - orange	50-70kg	30 ml	7.5
34597	Laryngeal Mask N 5 - blue	70-100 kg	40 ml	8.0

# STANDARD LARYNGOSCOPE BLADES AND SETS - 2.5 V

## McINTOSH BLADES

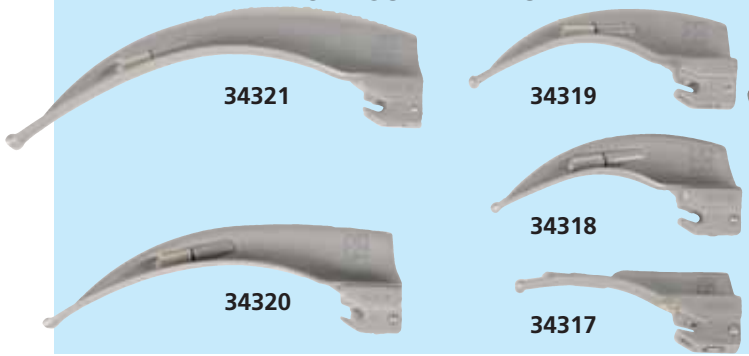

## MILLER BLADES

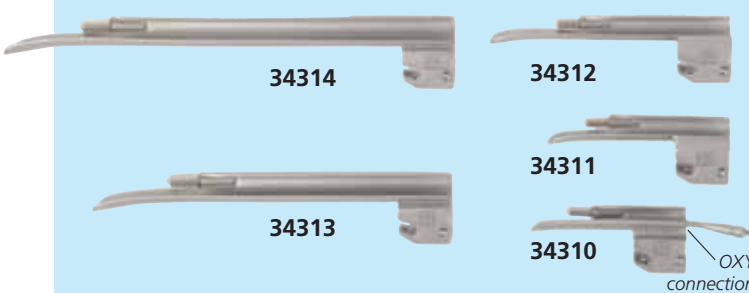

Great features of the unique GIMA blades and handles

- standard 2.5 V vacuum bulb
- light ergonomic, satin finish handle to reduce glare
- Stainless Steel contacts guarantee long working life
- easy sterilization ETO or steam
- full range of Mc Intosh & Miller blades, latex free
- ISO 7376 fittings allow use of blades with existing handles
- set is packaged in an anti-shock case and in cardboard box
- 2.5 V handles work with both alkaline batteries or rechargeable batteries
- good light transmission of 3,500 LUX with 2.5 V handles
- autoclavable up to 134° for 5 minutes (approx. 2,000 times)
- non magnetic blades and handles

### GIMA code STANDARD RECHARGEABLE SETS (HANDLE+BLADES)

<b>34301</b>	Pediatric set	2 blades MILLER 0-1
<b>34307</b>	Pediatric set	3 blades MILLER 00-0-1
<b>34305</b>	Pediatric set	3 blades MILLER 0-1, Mc INTOSH 0
<b>34306</b>	Doctor set	3 blades MILLER 1, 2, 3
<b>34302</b>	Adult set	3 blades Mc INTOSH 2-3-4
<b>34303</b>	Adult set	4 blades Mc INTOSH 1-2-3-4

### GIMA code BULBS, BATTERIES AND RECHARGEABLE HANDLES

<b>34352</b>	Small rechargeable handle - pediatric (2xAA) - 2.5 V
<b>34354</b>	Large rechargeable handle - adult (2XC) - 2.5 V
<b>34466</b>	Pediatric rechargeable Li-ion battery 2.5 V AA
<b>34467</b>	Adult rechargeable Li-ion battery 2.5 V "C"
<i>Charging time 2.5 hours (34466), 5 hours (34467)</i>	
<b>31542</b>	Charging station (including pediatric adaptor, wall support, UK, US and EU plug) 100-240 V
<b>34324</b>	Small Bulbs for MAC N°0 and MILLER N°00,0,1
<b>34325</b>	Large Bulbs for MAC N°1,2,3,4 and MILLER N°2,3
<i>compatible with Kawe and Riester</i>	



GIMA code	STANDARD BLADES	Overall Length mm	Distal Width mm
<b>34310</b>	Blade N° 00 MILLER OXY - premature	65	12.5
<b>34311</b>	Blade N° 0 MILLER - premature/newborn	78	11.5
<b>34312</b>	Blade N° 1 MILLER - babies	102	11.5
<b>34313</b>	Blade N° 2 MILLER - adults	155	16.5
<b>34314</b>	Blade N° 3 MILLER - adults/large	195	16.5
<b>34317</b>	Blade N° 0 Mc INTOSH - newborn	80	13
<b>34318</b>	Blade N° 1 Mc INTOSH - babies	92	14
<b>34319</b>	Blade N° 2 Mc INTOSH - infants	100	14
<b>34320</b>	Blade N° 3 Mc INTOSH - adults	130	18
<b>34321</b>	Blade N° 4 Mc INTOSH - adults/large	155	18

# DISPOSABLE F.O. LARYNGOSCOPE BLADES MILLER AND MC INTOSH

## SINGLE-PATIENT USE LARYNGOSCOPE F.O. BLADES

Choice of 5 different blades: Mc Intosh N° 2, 3, 4 and Miller N° 0,1. All blades are tested for tensile strength. Individually packed, non sterile.

**COMPATIBILITY WITH ALL "GREEN" F.O. SYSTEMS**

GIMA code	DISPOSABLE BLADES NON STERILE	Overall Length mm	Distal Width mm
<b>34481</b>	Metal handle		
<b>34364</b>	Plastic handle		
<b>34365</b>	N° 0 Miller - infant	90	22
<b>34366</b>	N° 1 Miller - child	100	23.3
<b>34375</b>	N° 2 Mc Intosh - adult small	115	34.4
<b>34376</b>	N° 3 Mc Intosh - adult	132	40.6
<b>34377</b>	N° 4 Mc Intosh - adult large	155	58.7
<b>34359</b>	Bulb for old plastic handle sold up to may 2016		
<b>34358</b>	Bulb for new plastic handle sold since june 2016		



- **34381 EMERGENCY PACK:** plastic handle +3 disposable blades Mc Intosh N° 2,3,4
- **34382 NYLON BAG - empty**
- **34384 EMERGENCY CASE:** plastic handle+6 disposable blades Miller 0,1,2 and Mc Intosh 2,3,4.



# GIMA GREEN F.O. XENON/HALOGEN AND LED LARYNGOSCOPES



## GIMA GREEN LARYNGOSCOPES

- maximum light transmission thanks to durable and high quality fibres
- specially designed blades for easy intubation
- matt finished to reduce glare
- autoclavable up to 134°C for 5 minutes. Blades autoclavable up to 2,000 times
- compatible to plasma sterilization
- all blades are compatible to BS EN ISO 7376 Green standard handles
- all blades are made from Austenitic Stainless steel thereby making them rust proof
- long life blades. GIMA offers 3 years Warranty
  - a large selection of power sources to use: 'AA' and 'C' type batteries or 2.5 V and 3.5 V rechargeable batteries
  - 2.5 V handles can be used with standard or rechargeable batteries
  - handles are available with 2.5 V and 3.5 V Xenon/Halogen and LED bulbs
  - all blades and handles are non magnetic

### Mc INTOSH BLADES

### MILLER BLADES

### HALOGEN/XENON BATTERY HANDLE

### LED BATTERY HANDLE

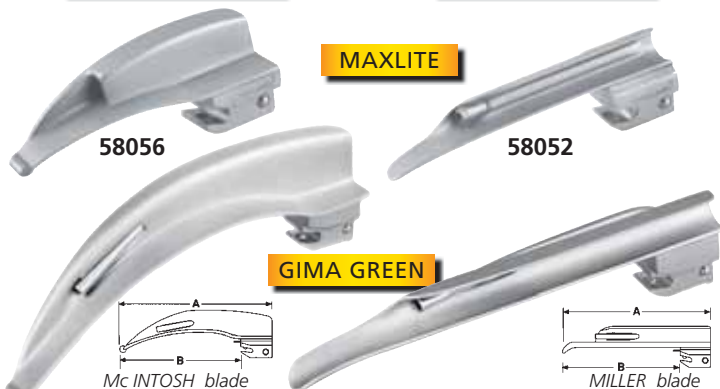

### Gima Green and Maxlite: Miller and Mc-Intosh blades

- Gima Green 4.0 mm Ø F.O. bundle with more than 5,500 individual fibre strands
- Miller Maxlite 3.0 mm Ø bundle with more than 5,000 individual fibre strands
- McIntosh Maxlite 4.5 mm Ø bundle with more than 6,500 individual fibre strands

### High quality fibres ensuring excellent light transmission Gima Green and Miller

Maxlite: 7,000 lux with 2.5 V Xenon/Halogen lamp, 12,500 lux with 3.5 V Xenon/Halogen lamp, 18,000 lux with 2.5 LED lamp, 30,000 lux with 3.5 V LED lamp

McIntosh Maxlite: 8,000/14,000/20,000/40,000 lux

GIMA code	"GIMA MAXLITE" FIBRE OPTIC BLADES	A	B
58051	MILLER N° 0 blade - Newborn	80	55
58052	MILLER N° 1 blade - Infant	100	75
58056	Mc INTOSH N° 0 blade - Newborn	82	57
58057	Mc INTOSH N° 1 blade - Infant	93	68
58058	Mc INTOSH N° 2 blade - Child	115	90
58059	Mc INTOSH N° 3 blade - Adult	135	110
58060	Mc INTOSH N° 4 blade - Adult large	155	130
58061	Mc INTOSH N° 5 blade - Adult x-large	176	151

GIMA code	"GIMA GREEN" FIBRE OPTIC BLADES*	A	B
34460	MILLER N° 00 OXY blade - Premature	65	40
34461	MILLER N° 0 blade - Newborn	78	53
34462	MILLER N° 1 blade - Infant	102	77
34463	MILLER N° 2 blade - Child	155	130
34464	MILLER N° 3 blade - Adult	195	170
34469	Mc INTOSH N° 0 blade - Newborn	80	55
34470	Mc INTOSH N° 1 blade - Infant	92	67
34471	Mc INTOSH N° 2 blade - Child	100	75
34472	Mc INTOSH N° 3 blade - Adult	130	105
34473	Mc INTOSH N° 4 blade - Adult large	155	130
34474	Mc INTOSH N° 5 blade - Adult x-large	175	150

\*equipped with detachable fibre optic light guide

### F.O. LIGHT GUIDE FOR GIMA GREEN BLADES

34483	F.O. Light guide for "GIMA Green" N°3
34484	F.O. Light guide for "GIMA Green" N°4
34486	F.O. Light guide for "GIMA Green" other - specify code

• 31542 GIMA GREEN CHARGING STATION - 100/200 V - 50/60 Hz  
It can charge either 2.5 V / 3.5 V NiCa, NimH or Li-ion rechargeable batteries independently of their status of charge. Unit is designed to prevent over charging of batteries. Simultaneously charging of pediatric and adult handle.



Charging station includes pediatric adaptor, wall support, UK, US and EU plug

### Xenon/Halogen and LED handles 2.5 V and 3.5 V

- closed battery compartment prevent liquid penetrating inside the battery
- handles are supplied with lamp. Battery not included
- solid metal handle of chromium plated metal

GIMA GREEN RECHARGEABLE BATTERY HANDLES						
GIMA code	F.O. XENON/HALOGEN BATTERY HANDLES - 2.5 V					
34480	Pediatric rechargeable metal handle (2xAA) - 2.5 V					
34481	Adult rechargeable metal handle (2xC) - 2.5 V					
34466	Pediatric rechargeable Li-Ion battery 2.5 V 1,000 mAh					
34467	Adult rechargeable Li-Ion battery 2.5 V 2,200 mAh					
34485	Halogen bulb 2.5 V (minimum order 6 pcs)					
"GIMA GREEN" RECHARGEABLE HANDLES AND BATTERIES 3.5 V - OLD up to lot 8 (ped handle) up to lot 7 (adult handle)						
34487	Pediatric rechargeable metal handle (3.5 V) - old					
34488	Adult rechargeable metal handle (3.5 V) - old					
34489	Pediatric rechargeable NiCa battery 3.5 V/700 mAh for 34487					
34490	Adult rechargeable NiCa battery 3.5 V/1,300 mAh for 34488					
34491	Halogen Bulb 3.5 V					
F.O. XENON/HALOGEN BATTERY HANDLE 3.5 V						
34456	Pediatric rechargeable metal handle (3.5 V)					
34457	Adult rechargeable metal handle (3.5 V)					
31540	Pediatric rechargeable Li-ion battery** 3.5 V for 34456					
31541	Adult rechargeable Li-ion battery** 3.5 V for 34457, 34482					
**for handles sold after may 2013						
34491	Halogen Bulb 3.5 V					
F.O. LED BATTERY HANDLES 2.5 V AND 3.5 V						
34476	Pediatric LED rechargeable handle 2.5 V					
34477	Adult LED rechargeable handle 2.5 V					
34482	Adult rechargeable metal handle - LED light 3.5 V					
COMPATIBILITY HANDLE - BATTERY - BULB						
GIMA code	Handle		V	Battery		Bulb
	Xenon	LED		Standard 2xAA	Rechargeable 2xC Li-ion*	
34480	Ped.	-	2.5	yes	no	34466
34481	Adult	-	2.5	no	yes	34467
34456	Ped.	-	3.5	no	no	31540
34457	Adult	-	3.5	no	no	31541
34476	-	Ped.	2.5	yes	no	34466
34477	-	Adult	2.5	no	yes	34467
34482	-	Adult	3.5	no	no	31541

\*Li-ion batteries have twice the capacity of an equivalent size NimH batteries.

# GIMA GREEN F.O. XENON/HALOGEN, LED LARYNGOSCOPE SETS



## GIMA F.O. XENON/HALOGEN AND LED SETS

- Mc Intosh or Miller blades
- F.O. laryngoscopes provide cool bright illumination
- Gima Green F.O. blades with detachable fibre or Maxlite F.O. blades with integrated fibre
- Xenon/Halogen or LED F.O. rechargeable battery handle
- 2.5 V or 3.5 V rechargeable battery handle (battery not included). 2.5 V rechargeable battery handle can be used with standard or rechargeable batteries. Rechargeable battery handles should be used with charging station 31542 (not included).
- non magnetic blades and handles

### LARYNGOSCOPE SET WITH F.O. BLADES

GIMA code	GIMA GREEN F.O. XENON/HALOGEN SET - 2.5 V	
34451	Pediatric set	2 blades Miller 0-1
34454	Pediatric set	3 blades Miller 0-1, Mc Intosh 0
34452	Adult set	3 blades Mc Intosh 2-3-4
34453	Adult set	4 blades Mc Intosh 1-2-3-4
34455	Doctor set	3 blades Miller 1-2-3
34485	Halogen bulb 2.5 V (minimum order 6 pcs)	
34450	Empty box without sponge	
GIMA code	GIMA GREEN F.O. LED SET - 2.5 V OR 3.5 V	
34327	Adult set	3 blades Mc Intosh 2-3-4 - 2.5 V
34328	Adult set	4 blades Mc Intosh 1-2-3-4 - 2.5 V
34329	Adult set	3 blades Mc Intosh 2-3-4 - 3.5 V
34330	Adult set	4 blades Mc Intosh 1-2-3-4 - 3.5 V

## MAXLITE F.O. BLADE WITH INTEGRATED FIBRE

Built with an integrated F.O. bundle with no cavities to trap dirt or body fluids, this allowing the blade to be easily cleaned and decontaminated.



GIMA GREEN F.O. BLADE

### TECHNICAL SPECIFICATIONS - BLADES AND BULBS

	Gima Green F.O. blade	Maxlite F.O. Mc Intosh blade
Fibre light carrier:	detachable	integrated
F.O. bundle Ø:	4.0 mm	4.5 mm
Individual fibre strands:	> 5,500	> 6,500
Light transmission with 2.5 V (Xenon):	7,000 lux	8,000 lux
Light transmission with 2.5 V (LED):	18,000 lux	20,000 lux
Light transmission with 3.5 V (Xenon):	12,500 lux	14,000 lux
Light transmission with 3.5 V (LED):	30,000 lux	40,000 lux
Autoclavable at 134 °C:	2,000 times	2,000 times
LED bulb life:	50,000 hours	50,000 hours

### LARYNGO SET WITH F.O. BLADES - INTEGRATED FIBRE

GIMA code	MAXLITE F.O. XENON/HALOGEN SET - 2.5 V	
34332	Pediatric set	3 blades Miller 00-0-1
34333	Adult set	3 blades Mc Intosh 1-2-3
34334	Adult set	4 blades Mc Intosh 1-2-3-4
34485	Halogen bulb 2.5 V (minimum order 6 pcs)	
GIMA code	MAXLITE F.O. LED SET - 2.5 V or 3.5 V	
34336	Pediatric set	3 blades Miller 00-0-1 - 2.5 V
34335	Adult set	3 blades Mc Intosh 2-3-4 - 2.5 V
34337	Adult set	4 blades Mc Intosh 1-2-3-4 - 2.5 V
34338	Adult set	4 blades Mc Intosh 1-2-3-4 - 3.5 V
GIMA code	BATTERIES for GIMA GREEN and MAXLITE	
34466	Pediatric rechargeable Li-ion battery 2.5 V 1,000 mAh	
34467	Adult rechargeable Li-ion battery 2.5 V 2,200 mAh	
31541	Adult rechargeable Li-ion battery 3.5 V*	

\*Packed and shipped at half charged state

# FLEXTIP F.O. XENON/HALOGEN AND LED SETS FOR DIFFICULT INTUBATIONS

## F.O. SET FOR DIFFICULT INTUBATION

Deluxe boxed set including one F.O. rechargeable handle, one or two F.O. Mc Intosh blades N° 3 or N° 3 and 4, for difficult intubations and bulb. The movable blade tip facilitates lifting of the epiglottis and enables a perfect visibility of the intubation process even in case of difficult anatomical conditions. A better visibility and a lower lever force reduce the risk of injury of the larynx and the teeth. Autoclavable at 134° C.

- stainless steel construction, matt finish
- can be used with all Green Spec Handles
- compatible with ISO 7376 Green Standards
- channel provides improved viewing area
- 4.0 mm fibre bundles (GimaGreen) or 4.5 mm fibre bundle (Maxlite) for maximum light output
- 2x"C" batteries or rechargeable batteries



GIMA code	FLEXTIP F.O. SET - 2.5 V	
34492	GIMA GREEN FLEXI F.O. SET 1 blade Mc Intosh 3	
34495	GIMA GREEN FLEXI F.O. SET 2 blades Mc Intosh 3-4	
34498	MAXLITE F.O. LED FLEXI SET 2 blades Mc Intosh 3-4 with integrated fibre	

GIMA code	ACCESSORIES AND SPARES	
34493	FLEXI F.O. BLADE N° 3 Mc Intosh (130x105 mm)	
34494	FLEXI F.O. BLADE N° 4 Mc Intosh (155x130 mm)	
34485	Bulb 2.5 V - spare	
34467	Adult rechargeable Li-ion battery 2.5 V	
31542	Charging station 100-240 V - see page 327	

# HEINE CLASSIC+® F.O. XHL OR LED<sup>HQ</sup> LARYNGOSCOPES

## HEINE CLASSIC+® F.O. XHL OR LED<sup>HQ</sup> LARYNGOSCOPES

The "Classic+" range of F.O. blades with HEINE HiLite® Fibre bundle with over 6,500 individual micro-fibres offer improved light transmission and longer life. Together with the innovative HEINE LED<sup>HQ</sup> light in the handle or the traditional XHL Xenon Halogen Bulb, the exclusive HEINE HiLite® Fibre Optic bundle with up to 4.3 mm of Ø offers 3X or 40% brighter light as with other conventional halogen bulbs.

**5 years warranty** 5-years guarantee or 4,000 standard autoclave cycles of 134°C/5 min. with more than 1,000 lux on all blades with HEINE HiLite® fibre bundle.

**Long lasting bulbs** HEINE XHL® Xenon Halogen bulbs incorporate the latest Xenon Halogen Technology to give you up to 40% more light! HEINE XHL Xenon Halogen 3.5 V bulbs last up to twice as long as 2.5 V bulbs and give up to three times the light of conventional 2.5 V Halogen laryngoscope bulbs. HEINE LED<sup>HQ</sup> handles offer even three times the light intensity of the 3.5V Xenon Halogen bulbs for an outstanding and constant bright illumination.

**Long lasting 3.5 V rechargeable batteries** HEINE 3.5 V systems (LED<sup>HQ</sup> or XHL) use a long-lasting 3.5 V lithium rechargeable battery which avoids the need to replace non-rechargeable batteries at frequent intervals. HEINE F.O. laryngoscope blades and handles are compatible with the ISO 7376 (green standard).

For fast charge in 2 hours

Size: 14x6x6.6 cm



34374

• 34374 NT 4 CHARGER UNIT FOR 2 HANDLES - X-002.99.494

Two independent charging compartments:

- fast charge capability: 2 hours for Li-ion handle
- automatic charging
- charger indicator



GIMA code	HEINE code	HEINE FIBRE OPTIC BLADES	Overall length	Distal length
34411	F-000.22.119	MILLER 00	76 mm	9.5 mm
34412	F-000.22.120	MILLER 0	80 mm	10.5 mm
34413	F-000.22.121	MILLER 1	100 mm	11.5 mm
34414	F-000.22.122	MILLER 2	152 mm	13 mm
34415	F-000.22.110	PAED 0	82 mm	12 mm
34416	F-000.22.111	PAED 1	95 mm	13 mm
34417	F-000.22.100	MAC 0	82 mm	9 mm
34418	F-000.22.101	MAC 1	93 mm	11 mm
34419	F-000.22.102	MAC 2	115 mm	13 mm
34420	F-000.22.103	MAC 3	135 mm	15 mm
34421	F-000.22.104	MAC 4	155 mm	15 mm
34422	F-000.22.105	MAC 5	176 mm	15 mm
34423	F-000.22.313	MAC 3 - Flex Tip+	115 mm	13.2 mm
34368	F-000.22.314	MAC 4 - Flex Tip+	137 mm	13.2 mm

**HEINE STANDARD LARYNGOSCOPE HANDLES AND ACCESSORIES**

34430	F-001.22.800	Slim F.O. handle 2.5 V - pediatric
34400	F-001.22.812	Short F.O. handle 2.5 V - pediatric and obese
34401	F-001.22.860	Standard F.O. handle 2.5 V
34405	F-008.22.860	Standard F.O. handle 2.5 V LED
31769	X-001.88.035	Spare bulb 2.5 V for 34400, 34401, 34430
31768	X-002.88.044	Spare bulb 3.5 V for 34369

**HEINE RECHARGEABLE LARYNGOSCOPE HANDLES AND BATTERIES**

34371	F-008.22.804	Pediatric LED handle 2.5 V Li-ion rechargeable*
34372	F-007.22.894	Standard F.O. handle 3.5 V Li-ion - rechargeable*
34373	F-008.22.894	Standard LED handle 3.5 V Li-ion - rechargeable*
34378	X-007.99.104	Re-chargeable 2.5 V battery pediatric for 34371
34448	X-007.99.383	Re-chargeable 3.5 V battery for 34372-3, 34402, 34367

**HEINE CLASSIC+® FIBRE OPTIC LARYNGOSCOPE SETS\*\* with 2.5V handle**

34403	F-119.10.860	3 blades set with paed 1, mac 2, mac 3, XHL handle
34404	F-120.10.860	4 blades set with paed 1, mac 2, mac 3, mac 4, XHL handle
34446	F-120.18.860	4 blades set with paed 1, mac 2, mac 3, mac 4, LED HQ handle
<b>with 3.5V rechargeable handle</b>		
34367	F-119.94.865	3 blades set with paed 1, mac 2, mac 3, LED HQ rechargeable handle

\*\*Set includes spare bulb and F.O. handle 2.5 V (34401) or F.O. LED handle 2.5 V

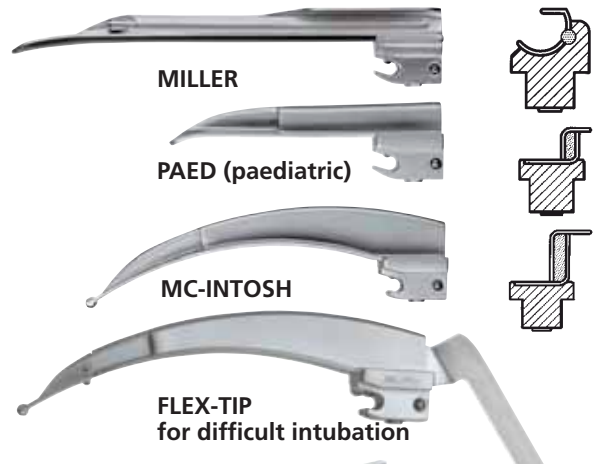

**STANDARD HANDLE 3.5V LED Li-ion®**

Rechargeable 3.5V F.O. LED handle with charge status display in bottom cap. State of charge is indicated for 10 seconds after switching on or after removing from the charger. Two hours charging time with NT4 charger, up to 13 hours ON time.

**LED HANDLE:**  
- 5,000 Kelvin  
- 12,000 LUX at 40 mm  
- 50,000 hours bulb life

Handle with charge status display

**LED HQ**  
LED NOW IN HEINE QUALITY.



# AMBU® KING VISION® VIDEO LARYNGOSCOPE

## • 58101 KING VISION® VIDEO LARYNGOSCOPE SET

The King Vision® video laryngoscope is especially designed to visualize, in the most reliable way, the airways for routine and difficult intubations.

The reusable display is lightweight, water resistant, non-glare, smudge-proof, packaged in a protective foam case and is battery operated.

The blades are disposable and are individually packaged, eliminating cross contamination risks. It can be used continuously about 80 minutes, making it highly portable.

Video output compatible with external monitor and recording devices.

**Two blade types:** a standard blade that requires the use of a stylet to direct the ET tube and a channeled blade where you can guide the ET tube with the blade.

Made in the U.S.A.

- 58104 STANDARD VISION BLADE - size 3 - spare
- 58105 CHANNELED VISION BLADE - size 3 - spare

### STANDARD ACCESSORIES

- Vision display
- 3 channeled vision blades - size 3
- 1 standard vision blade - size 3
- AAA batteries
- Case



Full colour TFT LCD display anti-reflective

Protective gasket

Ergonomic design. Integrated blade/handle design for complete control

Channeled and standard disposable blades for guided or standard insertions

Guiding channel for easy ETT placement and removal

New optics and light in every blade

58101

New anti-fog lens in every blade

# USB F.O. LARYNGOSCOPE HANDLE

## • 34468 USB F.O. LARYNGOSCOPE HANDLE

Universal USB handle for green fibre optic blades. This handle is a charging unit including lithium-ion rechargeable battery and USB port for easy recharging without charging station.

Features:

- glass bead blasted, matt chromium plated surface for a high quality optic
- no surface structure, lateral grooves for hygienic use and secure grip in the hand
- metallic lamp case
- quick and easy removal of bulb
- autoclavable up to 134° (without batteries)
- handle in accordance with ISO 7376 (green standard)

Made in Germany.



USB port

IN ACCORDANCE WITH ISO 7376 FOR ALL GREEN F.O. BLADES



34468



Handle supplied in a rigid case with 3 adapters (US, GB, EU)

# F.O. LARYNGOSCOPE BLADES AND BATTERY HANDLES SINGLE PATIENT STERILE

## SINGLE PATIENT USE F.O. LARYNGOSCOPE BLADES

Choice of 6 blades Miller 0.1 and McIntosh 1, 2, 3, 4 for everyday hospital use. Compatible to ISO 7376 Green System. Light conductor made from material with excellent light transmission: 4,000 lux with 2.5 V Xenon handle and 10,000 lux with LED handle. Need F.O. handle.

A high impact resistant plastic block coupled with metal spatula provides great strength to the whole blade comparable to all metal reusable blades



GIMA code	SINGLE PATIENT F.O. BLADES	A	B
58001	MILLER N° 0 blade - Newborn	78	54
58002	MILLER N° 1 blade - Infant	105	80
58006	Mc INTOSH N° 1 blade - Infant	90	66
58007	Mc INTOSH N° 2 blade - Child	100	76
58008	Mc INTOSH N° 3 blade - Adult	130	106
58009	Mc INTOSH N° 4 blade - Adult large	155	131

## SINGLE PATIENT USE BATTERY HANDLES

- lightweight, suitable for everyday hospital use
- single patient use, prevent cross infection
- compatible to ISO 7376 Green System
- perfect solution to cleaning problems confronting EMS field
- Ready To Use (RTU) handles are supplied with preloaded batteries, thus eliminating the hessel of loading batteries
- the 'C' type handles are identified with yellow colour bottom cap, supplied without batteries
- suitable also for reusable blades
- made in ABS



58012

58014

58015

GIMA code	SINGLE PATIENT USE F.O. LED BATTERY HANDLES 2.5 V
58012	Battery handle "C" type - adult
58014	Battery handle "RTU" (ready to use) - pediatric
58015	Battery handle "RTU" (ready to use) - adult

**EMERGENCY KITS COMPLETE WITH STANDARD EMERGENCY DEVICES**



34173

**SMART BAGS - medium - blue**

- 27152 SMART BAG - medium empty - 55x35xh 32 cm
- 34173 "GIMA 3" EMERGENCY BAG - filled - without cylinder



34174

**SMART BAGS - large - red**

- 27153 SMART BAG - large empty - 65x35xh 35 cm
- 34174 "GIMA 7" EMERGENCY BAG - filled



34163

**LOGIC 2 RUCKSACKS - red**

- 27171 LOGIC 2 RUCKSACK - empty - 40x25xh 47 cm
- 34162 "GIMA 8" EMERGENCY RUCKSACK - filled
- 34163 "GIMA 9" EMERGENCY RUCKSACK - filled
- 34164 "GIMA 10" EMERGENCY RUCKSACK - filled - without cylinder
- 34175 "GIMA 11" EMERGENCY RUCKSACK - filled

**LOGIC 2 RUCKSACKS PVC COATED - red**

- 27172 LOGIC 2 RUCKSACK PVC COATED - empty - 40x25xh 47 cm
- 34165 "GIMA 12" EMERGENCY RUCKSACK PVC COATED - filled - same as "GIMA 9", without cylinder

27172



**EMERGENCY ALUMINIUM CASE**

- 34159 ALUMINIUM CASE - empty - 40x35x10 cm
- 34161 "GIMA 2" EMERGENCY CASE - filled

34161

Aluminium emergency case



34156

**EMERGENCY BAGS - red**

- 27165 EMERGENCY BAG - empty - 35x45x21 cm
- 34155 "GIMA 6" EMERGENCY BAG - filled - without cylinder
- 34156 "GIMA 4" EMERGENCY BAG - filled
- 34157 "GIMA 5" EMERGENCY BAG - filled

**EMERGENCY BAGS PVC COATED - blue**

- 27167 EMERGENCY BAG PVC COATED - empty - 35x45xh 21 cm
- 34154 "GIMA 13" EMERGENCY BAG PVC COATED - filled - same as "GIMA 4", without cylinder

27167



34176

**IP67 CERTIFIED DURABLE CASE - waterproof and dustproof**

- 27222 LARGE DURABLE CASE - empty - 55x43xh 21 cm
- 34176 "GIMA 1" EMERGENCY DURABLE CASE - filled

## EMERGENCY KITS - BAGS, RUCKSACKS, CASES

KIT CONTENTS	Size cm	34155	34156	34157	34154	34173	34174	34161	34176	34162	34163	34164	34175	34165
		GIMA 6 bag	GIMA 4 bag	GIMA 5 bag	GIMA 13 bag	GIMA 3 bag	GIMA 7 bag	GIMA 2 al case	GIMA 1 pl case	GIMA 8 rucksack	GIMA 9 rucksack	GIMA 10 rucksack	GIMA 11 rucksack	GIMA 12 rucksack
<b>Container (bag, rucksack or case)</b>														
Smart bag - medium - blue 600D polyester (27152)	55x35xh 32					•								
Smart bag - large - red 600D polyester (27153)	65x35xh35						•							
Emergency bag - red 600D polyester (27165)	35x45xh 21	•	•	•										
Emergency bag - blue 600D polyester PVC coated (27167)	35x45xh 21				•									
Logic 2 rucksack - red 600D polyester (27171)	40x25xh 47								•		•		•	
Logic 2 rucksack - red 600D polyester PVC coated (27172)	40x25xh 47													•
Durable case - orange (27222)	55x43xh 21								•					
Aluminium case (34159)	40x35xh 10							•						
<b>Products included in kits</b>														
Emergency cover (34085)		•	•	•	•	•	•	•	•	•	•	•	•	•
Universal scissors - 15 cm (34128)		•	•	•	•	•	•	•	•	•	•	•	•	•
Facemask n. 2 - child/small (34222)		•	•	•	•	•	•	•	•	•	•	•	•	•
Silicone resuscitator bag with mask n 4 - adult (34245)		•	•	•	•	•	•	•	•	•	•	•	•	•
Teeth screw driver (34273)		•	•	•	•	•	•	•	•	•	•	•	•	•
Tongue holding forceps (34274)		•	•	•	•	•	•	•	•	•	•	•	•	•
Oxygen tube - 120 cm (34276)		•	•	•	•	•	•	•	•	•	•	•	•	•
Mixed Guedel airways - box of 10 (34439)		•	•	•	•	•	•	•	•	•	•	•	•	•
Oxygen therapy mask - adult (34166)		•	•	•	•	•	•	•	•	•	•	•	•	•
0.5 l oxygen cylinder (empty) with reducer UNI std (34500)		•	•	•	•	•	•	•	•	•	•	•	•	•
Yton nurse stethoscope (32514)		•	•	•	•									
Jotarp dual head stethoscope - black (32580)					•	•	•	•	•	•	•	•	•	•
Yton sphygmomanometer (32720)		•	•		•									
London sphygmomanometer (32725)				•		•	•	•	•	•	•	•	•	•
Welch Allyn DURASHOCK sphygmomanometer (32700)														•
Emergency pack - 3 F.O. single-use blades+plastic handle (34381)		•	•		•					•				
Laryngoscope set 3 Mc-Intosh blades 2-3-4 (34302)				•		•	•		•		•	•		•
"Gima green" F.O. laryngoscope set 4 Mc-Intosh blades 1-2-3-4 (34453)														•
Hand suction unit (28180)		•				•	•						•	
Res-q-vac hand suction unit (28124)				•					•				•	•
Delta pen light (25629)				•		•	•		•			•	•	•
Fast tourniquet - green (25728)				•		•	•		•			•	•	•
Magill forceps - 20 cm (34002)				•		•	•		•			•	•	•
Gima digital thermometer °C (25560)				•		•	•		•			•	•	•
Disinfectant wipes - tube 100 wipes (36625)				•		•	•		•			•	•	•
Emocontrol elastic bandage (34782)				•		•	•		•			•	•	•
Gauze bandage 3.5 m x 7 cm - box of 10 (34841)				•		•	•		•			•	•	•
Sterile adhesive dressing 10 x 10 cm - box of 6 (34851)				•		•	•		•			•	•	•
Oxy-4 fingertip oximeter (35092)						•	•		•			•	•	•
Instant ice - bag 3 pcs. (34111)						•	•		•			•	•	•
Burn dressing - 10x10 cm (34871)									•					•
3 E3 padded pouches with window red (27188), blue (27189), green (27191)									•			•	•	
2 E4 pouches with window red (27192), yellow (27194)									•					

## INTUBATION BAG WITH EMERGENCY ACCESSORIES

- 27133 INTUBATION BAG - empty
  - 34152 INTUBATION KIT - complete
  - 34153 INTUBATION KIT F.O. - complete
- Compact nylon bag suitable for various uses:  
2 internal zip pockets, 9 elastic retainers for instruments, made in water-resistant anti-scratch 600D polyester, blue colour.  
Size: 32x22.5xh 7.5 cm.

STANDARD ACCESSORIES	34152	34153
Mc Intosh Laryngoscope	3	3 F.O.
s/s blades N 1, 2, 3		
Laryngoscope metal handle	1	1
Magill forceps	1	2
Tongue holding forceps	1	1
Guedel cannula	3	5
Mouth opener	1	1
Scissors cm 14.5	1	1
Endotracheal tubes	-	4



## MEDICATION FIRST AID BAG

- 27132 MEDICATION FIRST AID BAG - empty - 31x22x11 cm
  - 34149 MEDICATION FIRST AID BAG - filled
- First aid bag provided with 2 internal transparent pockets, one external pocket, internal division with 2 zip on both sides, handle and carrying belt.

### STANDARD ACCESSORIES

- London palm sphygmomanometer (32725)
- Yton single head stethoscope (32514)
- Delta Led pen light (25629)
- Fast tourniquet (25728)
- Digital thermometer (25560)
- Sterile adhesive dressing 10x10 cm - box of 6 (34851)
- Liester bandage scissors - 15 cm (34129)
- CPR mask (34218)
- Disinfectant wipes
- 3M Steri strips (34915 - 34916 - 34917 - 34918)
- Emergency cover (34085)



## GIMA RESUSCITATION KITS

- 34181 SPEED 1 RESUSCITATION KIT - UNI cylinder
- 34182 SPEED 2 RESUSCITATION KIT - NF cylinder
- 34183 SPEED 3 RESUSCITATION KIT - without cylinder
- 34180 SPEED EMPTY CASE - with sponge
- 34222 FACEMASK N° 2 - child small



First aid kits for reanimation, very useful for medical and dental rooms, sport clubs, factories, ambulances... Case made of anti-shock plastic. Size: 43 x 37 x 11 cm.

STANDARD ACCESSORIES	SPEED 1	SPEED 2	SPEED 3
Silicone resuscitation bag - autoclavable	•	•	•
Silicone Face mask n° 4	•	•	•
Oxygen cylinder 0.5 l (empty). UNI standard	•	•	•
Oxygen cylinder 0.5 l (empty). NF standard	•	•	•
High pressure manometer	•	•	•
Guedel airways (small + medium + large)	•	•	•
Helicoidal mouthwedge + Tongue holding forceps	•	•	•
Atoxing tubing for connection to oxygen cylinder	•	•	•
Plastic case	•	•	•



34181

## SPLINTER REMOVAL KIT



34190

Small metallic splinters, eye tool remove



Anti-abrasive nylon loop

34192

"NEODIMIO" magnetic point

The body is made of anodised aluminium and the neoprene seals guarantee a better pencil hold. Supplied in a box and CE marked.

- 34190 SPLINTER REMOVAL KIT

Includes everything to remove splinters and for first aid medications. In a polypropylene box size 235x190x43 mm:

- 1 Eye wash solution 100 ml with an eye glass
- 1 magnifying glass, 2 sterile gauze pads 18x40 cm
- 1 Professional removal pencil, 1 mirror.
- 1 stainless steel tweezers 11.5 cm

- 34192 PROFESSIONAL REMOVAL PENCIL

Small metallic splinters eye tool remover. On one side a magnetic point to remove any metallic splinter avoiding any risk for the eye. On the other side an antiabrasive nylon loop for non metallic splinters.

## EYE WASH SYSTEMS

- 34889 DROP - eye wash station

Thermo-formed wall kit with all necessary items for an efficient first emergency eye wash:

- 2 sterile saline solutions of 500 ml
- 2 integrated eye cups and one mirror.

- 34888 EYE WASH SOLUTION 500 ml
- sterile - spare



34889

## FIRST AID FAMILY CASE



Size: 235x190x43 mm

34136



Case in polypropylene

Guidance in: GB, FR, IT, ES, DE, TR

- 34136 FAMILY FIRST AID CASE

- 34450 EMPTY CASE

Small first aid case suitable for use anywhere and anytime: (at home or office, in the car or boat...). Made in Italy

### STANDARD ACCESSORIES

- |  |                                   |
|--|-----------------------------------|
| 2 sterile gauze pads 18x40 cm          | 3 antiseptic wipes                |
| 1 pair of scissors. 1 plastic tweezers | 1 adhesive dressing 10 x 6 cm     |
| 1 sterile bandage 60x40 cm             | 1 gauze bandage 5 cm              |
| 1 cotton wool pack 5 g                 | 1 adhesive plaster roll 2 cm x 1m |
| 1 pack of 10 adhesive plasters         | 1 pair of protection gloves       |
| 1 tissue pack 10 pcs                   | Guidance Leaflet 6 languages      |

## MEDICAL SPORT BAG



- 34135 MEDICAL SPORT BAG
- Special kit designed for first aid in sporting clubs (tennis clubs, swimming pools, gymnasium,....).

Soft nylon bag has 2 side pockets and zip closure.

Size: 470x240x190 mm  
Weight: 6.5 kg

### STANDARD ACCESSORIES

- |   |   |
|---|---|
| 1 isothermic blanket Gold/Silver 160x210 cm | 1 pack of 20 adhesive plasters 2x7 cm   |
| 1 Disinfectant liquid 250 ml                | 8 adhesive plasters 10x6 cm             |
| 2 adhesive plasters 5 m x 2,5 cm            | 1 sterile TNT bandage 60x40 cm          |
| 2 pairs of sterile gloves                   | 1 sterile TNT bandage 60x80 cm          |
| 2 VENTO mouth to mouth resuscitators        | 6 sterile TNT pads 10x10 cm             |
| 6 sterile gauze pads 18x40 cm               | 5 instant ice packs                     |
| 2 instant ice sprays 150 ml                 | 1 hydrogen peroxide solution            |
| 3 triangular TNT bandages 96x96x136 cm      | 1 elastic net bandage                   |
| 3 Elastic bandages 6 cm                     | 1 haemostatic lacet                     |
| 3 Elastic bandages 8 cm                     | 1 sterile tweezers                      |
| 1 cotton wool pack                          | 5 ammonia towelettes                    |
| 1 pair of LISTER scissors 14,5 cm           | 1 sterile saline solution bottle 250 ml |
| 2 compressive pad bandages 80x100 mm        | 1 gel hands disinfectant 100 ml         |
| 2 compressive pad bandages 100x120 mm       | guidance leaflet 5 languages            |

## FIRST AID CASE AND BAG



34184

Advised for offices or workshops of 2 people  
Meets Italian law 388-Art. 2

- 34184 SMALL KIT - plastic case

Size: 290x215x90 mm - 1.4 kg  
See content of kit at page 334

- 34188 REFILL PACK for 34184-34185-34194

- 34186 EMPTY PLASTIC CASE 290x215x90 mm

- 34185 MIZAR BAG - nylon

Size: 250x180x90 mm  
Same contents as 34184 see page 334

34185



# FIRST AID PLASTIC CASES AND METAL CABINETS



34196



34197

- 34196 MEDIUM KIT - plastic case Size: 275x240x123 mm - 2 kg
- 34197 MEDIUM KIT - metal cabinet Size: 370x300x140 mm - 3.8 kg
- 34187 REFILL PACK for code 34196-97
- 34141 EMPTY METAL CABINET 370x300x140 mm



34198



34195



34199

- 34195 LARGE KIT - plastic case 1 Size: 460x345x135 mm - 6.2 kg
- 34198 LARGE KIT - plastic case 2 Size: 395x270x135 mm - 6.2 kg
- 34199 LARGE KIT - metal cabinet Size: 460x300x140 mm - 7.5 kg
- 34189 REFILL PACK for code 34195-34198-34199 without sphygmomanometer
- 34191 EMPTY PLASTIC CASE 1 460x345x135 mm
- 34138 EMPTY PLASTIC CASE 2 395x270x135 mm



- 34143 METAL CABINET  
Supplied with 3 internal metal shelves, removable bottle floor support, 2 small shelves on the door, lock and key.  
Size 402x582x202 mm - 12.9 kg
- 34145 EMPTY METAL CABINET 402x582x202 mm

STANDARD CASES / CABINETS CONTENT	34194 34184-5	34196 34197	34195 34198-9	34143	34151	SPARES see page
Bags liquid soap		3		3		348
Bags antiseptic wipes		3		3		349
Bottle antiseptic solution 125 ml	1	1				-
Bottle antiseptic solution 250 ml				1		349
Bottle antiseptic solution 500 ml			2	3	2	-
Oxygenated water bottle				1		349
Ammonia bag		2		2		-
Pair protective gloves, sterile	2	2	5	5	5	19
Box of 10 assorted plasters	1	1	2		2	345
Box of 100 assorted plasters Plastosan				1		345
Box of 100 assorted 7x2 cm Plastosan				1		345
Adhesive plaster roll 2,5 cm x 5 m	1	1	2	2	2	343
Elastic bandage with clip 4,5 cm x 7 m				1		339
Pack of 8 assorted gauze bandages				1		339
Gauze bandage 10 cm x 3,5 m	1	1				339
Tubular net gauze			1	1	1	336
Pack of sterile compress 10 x 10 cm	3	3	10	10	10	341
Pack of sterile compress 18 x 40 cm	1	3	2	6	2	341
Pack of cotton wool	1	1	1	3	1	342
Mask with face shield			1	1	1	16
Pair of scissors cm 14,5	1	1	1	1	1	335
Sterile forceps	1	1	2	2	2	38
Haemostatic lacet	1	1	3	3	3	56
Sphygmomanometer + Stethoscope			1	1	1	229-250
Sterile blanket 40x60 cm		1	2	2	2	-
Pack of instant ice, single use	1	1	2	2	2	347
Digital thermometer			1	1	1	78
Trash bag	1	1	2	5	2	-
First aid multilanguage booklet	1	1	1	1	1	-
Guidance leaflet	1	1	1	1	1	-
Irrigating solution 250 ml	1	1				349
Irrigating solution 500 ml			3	3	3	-
Triangular blanket 96x96x136 cm		1		4		-
Isothermic blanket gold/silver 160x210 cm				1		347
Sterile burn gel sachet 3.5 g				3		347
Compressive Emocontrol bandage				1		339
Pinocchio helicoidal open mouth Vento				1		324
Autoclavable resuscitator with facemask N° 4					1	322
Oxygen bottle 0.5 l empty - UNI standard					1	320
Guedel airways					3	323
Atoxic tube for oxygen					1	324
Mouth opener					1	324

- 34151 GIMA 3 - FIRST AID CASE + OXYGEN CYLINDER  
Advised for up to 50 people Size: 32x44.5x15 cm  
Meets Italian law D.M. 388 (15.7.03) art. 1 + emergency kit.  
Emergency kit includes:  
- autoclavable resuscitation with security valve, and silicone mask n. 4.  
- oxygen bottle 0.5 l (empty) with reductor and oxygen distributor - UNI standard.  
- 3 guedel airways, atoxic tube for connection to oxygen, mouth opener and wall support.
- 34148 GIMA 3 - EMPTY PLASTIC CASE



34151

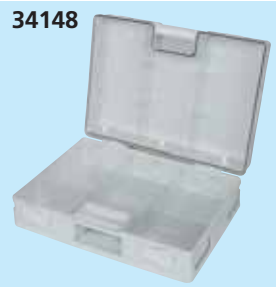

34148

## MASK FOR MOUTH-TO-MOUTH REANIMATION



**Ambu**  
Ideas that work for life

• **34216 LIFEKEY MASK**  
Pocket mask for mouth-to-mouth reanimation. Its special one-direction valve allows oxygen to flow straight to the patient and minimizes risks of cross-contamination. Single-use, non-sterile, made in atoxic transparent material, easy to use and carry. Suitable for adults and children.



**GIMA**

• **34218 CPR MASK - pocket resuscitator**  
The CPR pocket mask is a non-invasive, latex free mask with an integral non-rebreathing valve and efficient filter to prevent direct mouth contact with the patient's face when providing mouth-to-mouth resuscitation. It can be used on adult, child and infant. Supplied in a compact plastic box with a corrugated tube for an easier use.

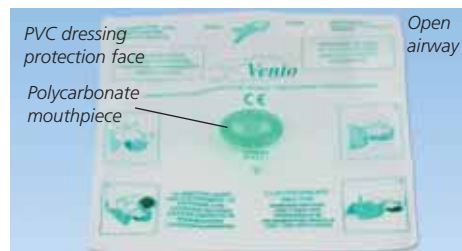

• **34211 VENTO AIRWAYS - Poly-bag**  
• **34213 VENTO AIRWAYS - Key-holder box**  
Disposable mouth to mouth airway with a one way polycarbonate valve and non-toxic pvc protective foil to avoid any direct contact between patient and rescuer. Available in 2 versions: in poly-bag or key-holder box. Instructions in GB, IT, FR, DE.

## EMERGENCY



• **34127 EMERGENCY SCISSORS**  
23.5x10.8 cm  
Autoclavable Stainless steel AISI 420. Made in Italy.

## LISTER BANDAGE S/S SCISSORS

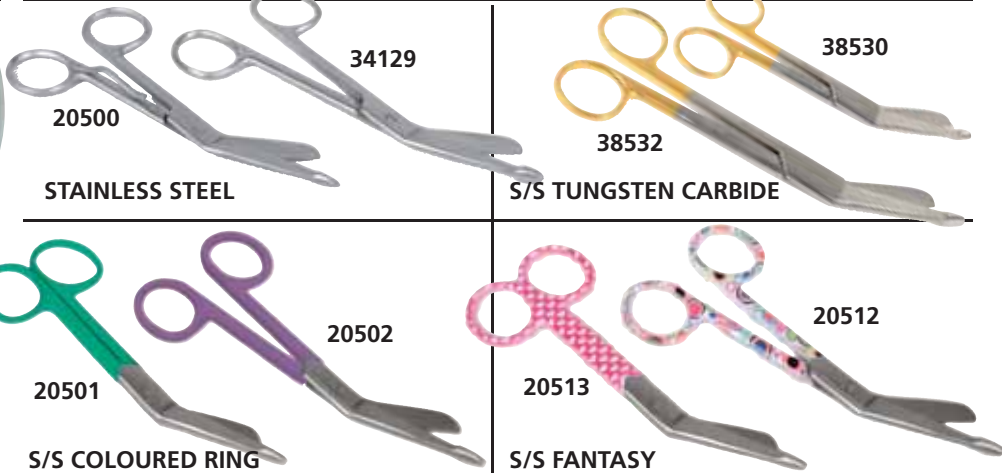

LISTER BANDAGE SCISSORS			
GIMA code	STAINLESS STEEL	GIMA code	FANTASY - COLOURED RING
34125	Lister - 11 cm	20501	Lister - Green ring - 14 cm
34129	Lister - 15 cm	20502	Lister - Lilac ring - 14 cm
34130	Lister - 18 cm	20509	Lister - Foot print - 14 cm
20500	Lister with belt clip - 14 cm	20511	Lister - Leopard - 14 cm
38530	Lister tungsten carbide - 14 cm	20512	Lister - Bubble - 14 cm
38532	Lister tungsten carbide - 18 cm	20513	Lister - Hearts - 14 cm

## STAINLESS STEEL UTILITY AND BANDAGES SCISSORS



All purpose, first aid scissors, easily cut bandages, leather and plaster casts. Autoclavable at 136°C

UTILITY SCISSORS			
12 cm - 4.7"	16.5 cm - 6.5"	19 cm - 7.5"	Colour
20560	20570	20580	Black
-	20571	20581	Blue
-	20572	20582	Red
-	20573	20583	Purple
-	20574	20584	Pink
20590	Steel chain for scissors and forceps		



## LEUKOTAPE® K NEUROMUSCULAR TAPE



### NEUROMUSCULAR TAPE

Elastic adhesive tape for neuromuscular taping. 100% cotton fabric coated with a strong acrylic adhesive mass. Water resistant. Latex-free. Multilanguage GB, FR, IT, ES, DE, PT, NL.



GIMA code	BSN code	LEUKOTAPE® K NEUROMUSCULAR TAPE
59010	72978-11	LEUKOTAPE® K 5 m x 5 cm - skin
59011	72978-16	LEUKOTAPE® K 5 m x 5 cm - red
59012	72978-21	LEUKOTAPE® K 5 m x 5 cm - blue
59013	72978-23	LEUKOTAPE® K 5 m x 5 cm - black
59014	72978-24	LEUKOTAPE® K 5 m x 5 cm - light blue
59015	72978-25	LEUKOTAPE® K 5 m x 5 cm - pink

## KINTAPE KINESIOLOGY TAPES

High quality Kinesiology tape conforms to all areas of the body. Provides firm support and compression. Ideal for treatment of muscular symptoms, stimulus to blood circulation and lymph and fascia diversion. Reduce pain improving athletic performance. Easy to tear and unwinds to the core. Individually packed in a plastic bag and cardboard box. - soft hypoallergenic cotton cloth, elasticity up to 160%

- 70% water proof (level 3) and sweat proof  
- supersticky: up to 7 days, over 10 days for kinesiology PRO  
**Kinesiology PRO:** supersoft and quick drying

GIMA code	KINESIOLOGY STANDARD TAPES - thickness 0.48 mm	Minimum order
34745	Kinesiology tape 5 m x 5 cm - black	box of 1
34746	Kinesiology tape 5 m x 5 cm - ceil blue	box of 1
34747	Kinesiology tape 5 m x 5 cm - red	box of 1
34749	Kinesiology tape 5 m x 5 cm - green	box of 1
34750	Kinesiology tape 5 m x 5 cm - pink	box of 1
34751	Kinesiology tape 5 m x 5 cm - skin	box of 1
34752	Kinesiology tapes 5 m x 5 cm - mix colours	box of 6
KINESIOLOGY PRO TAPES - thickness 0.32 mm		
34757	Kinesiology PRO tapes 5 m x 5 cm - skin	box of 1

Mixed colours box includes 6 rolls in different colours: ceil blue, red, pink, green, black, beige



Multilanguage box and instructions (GB, FR, IT, ES)

Made of 97% cotton, 3% spandex

34752

## FABRIC SPORT TAPES



34755

34754



Made in Italy

GIMA code	WHITE ZINC OXIDE FABRIC TAPE NON ELASTIC ADHESIVE BANDAGE	Minimum order
34753	Tape 14 m x 2.5 cm - for finger	box of 48
34754	Tape 14 m x 3.8 cm - for wrist	box of 30
34755	Tape 14 m x 5 cm - for ankle	box of 24

## ELASTICATED TUBULAR NET

Elastic tubular net for the application of gauze and medication. Versatile, suitable for all parts of the body. The special structure of the material allows a stretching which holds without compressing. Made in Italy.



GIMA code	Range	Length under tension: 25 m		
34701	1		4	
34702	2		5	
34703	3	1		7 small
34704	4		6	
34705	5		7	
34706	6	2		8 medium
34707	7		8	
34708	8	3		9 large
34709	9		9	

## STRAPPAL® SPORT TAPE

### STRAPPAL® SPORT TAPE

Inelastic adhesive bandage (tape) indicated in traumatology to limit the joint movements.

High quality fabric made of inelastic viscose fibres coated with a strong adhesive mass. Hand tearable. Latex free.

Multilanguage GB, FR, IT, ES, DE, PT, NL.



GIMA code	BSN code	STRAPPAL® SPORT TAPE	Minimum order
59051	71490-00	STRAPPAL® 10 m x 4 cm	box of 24
59052	71493-00	STRAPPAL® 10 m x 5 cm	box of 18



## COMPRILAN® COMPRESSIVE BANDAGES



**COMPRILAN® COMPRESSIVE BANDAGES**  
Short stretch compression bandage (90%) for phlebological and lymphological application. 100% cotton fabric (flesh colour). Stretched length 5 m. Washable and sterilizable. Latex-free.

GIMA code	BSN code	COMPRILAN® COMPRESSIVE BANDAGES	Minimum order
59150	01026-00	COMPRILAN® 5 m x 6 cm	box of 1
59151	01027-00	COMPRILAN® 5 m x 8 cm	box of 1
59152	01028-00	COMPRILAN® 5 m x 10 cm	box of 1
59153	01029-00	COMPRILAN® 5 m x 12 cm	box of 1

## ELASTIC COMPRESSION BANDAGES - LIGHT TO STRONG COMPRESSION



**STRONG COMPRESSION BI-ELASTIC**

**PREVIBIELASTICA**  
- medical prescription bandage  
- ideal for bandaging when support and strong, constant compression is required  
- used in the treatment of varicose veins and post-operative patients  
- its ability to stretch in any direction makes it ideal for bandaging joints.



**STRONG COMPRESSION**

**PREVIFORTE**  
- medical prescription bandage  
- compression bandage for phlebitis treatment  
- support bandage with strong, constant compression, ideal for varicose veins, for the prevention and cure of sport and work injuries. Suitable for distortions, light fractures and sprains.



**MEDIUM COMPRESSION**

**PREVINOVA**  
- universal compression bandage  
- protects and supports all types of medication  
- to fix medications, support light fractures, distortions, sprains, sport and work injuries with medium compression.

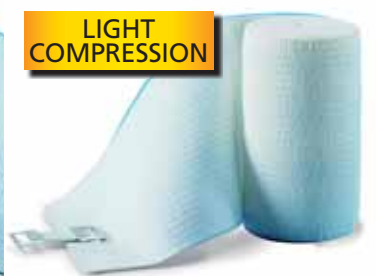

**LIGHT COMPRESSION**

**PREVIMEDICAL**  
- universal compression bandage  
- protects and supports all types of medication  
- to fix medications, for support and relief in case of contusions and haematomas with medium-light compression.

GIMA code	ELASTIC COMPRESSION BANDAGES individually packed, with clip	Minimum order
<b>PREVIBIELASTICA - strong compression</b>		
34644	PreviBielastica 7 m x 8 cm	box of 10
34645	PreviBielastica 7 m x 10 cm	box of 10
<b>PREVIFORTE - strong compression</b>		
34647	PreviForte 7 m x 8 cm	box of 10
34648	PreviForte 7 m x 10 cm	box of 10
<b>PREVINOVA - medium compression</b>		
34650	PreviNova 4.5 m x 6 cm	box of 10
34651	PreviNova 4.5 m x 8 cm	box of 10
34652	PreviNova 4.5 m x 10 cm	box of 10
<b>PREVIMEDICAL - medium light compression</b>		
34654	PreviMedical 5 m x 8 cm	box of 10
34655	PreviMedical 5 m x 10 cm	box of 10

TECHNICAL SPECIFICATIONS				
	PREVIBIELASTICA	PREVIFORTE	PREVINOVA	PREVIMEDICAL
Composition:	Cotton 70%	92%	69%	60%
	polyamide 19%	-	25%	33%
	polyurethane 11%	8%	6%	7%
Extensibility	longitudinal 160%	170%	250%	160%
	transversal 80%	-	-	-

## CO-PLUS® BANDAGES



**CO-PLUS® BANDAGES**  
Flexible cohesive bandage. Sticks only to itself, not on skin. Indications: support and compression in traumatology and phlebology. Longer than competitors (6.3 m stretched instead of 4.5 m). Multilingual box: GB, FR, IT, ES, DE, NL.



GIMA code	BSN code	CO-PLUS® BANDAGES	Minimum order
59182	72100-09	CO-PLUS® 6.3 m x 7.5 cm - skin	box of 1
59183	72100-04	CO-PLUS® 6.3 m x 10 cm - skin	box of 1
59186	72102-03	CO-PLUS® 6.3 m x 7.5 cm - mix colours*	box of 24
59187	72102-02	CO-PLUS® 6.3 m x 10 cm - mix colours*	box of 18

\*Mix of bandages in 6 colours (blue, light blue, red, violet, neon green, neon pink)

## 3M COBAN™ ELASTIC WRAP



Self-adherent cohesive elastic wrap

GIMA code	3M code	3M COBAN™ SELF ADHERENT COHESIVE ELASTIC WRAP - LATEX	Minimum order
34923	1583	COBAN™ 7.5 cm x 2 to 4.57 m	box of 24
34924	1584	COBAN™ 10 cm x 2 to 4.57 m	box of 18

## ELASTOMULL® HAFT COHESIVE BANDAGES



Multilanguage box:  
GB, FR, IT, ES, DE,  
PT, NL, SE

### ELASTOMULL® COHESIVE BANDAGES

Elastic retention bandage. It provides wound care splint retention and light support. Comfortable non woven fabric (cotton, viscose and polyamide) coated with synthetic latex. Stretched length 4 m.



GIMA code	BSN code	ELASTOMULL® HAFT COHESIVE BANDAGES	Minimum order
59211	45471-00	Elastomull® Haft 4 m x 6 cm	box of 10
59212	45472-00	Elastomull® Haft 4 m x 8 cm	box of 10
59213	45473-00	Elastomull® Haft 4 m x 10 cm	box of 10
59214	45474-00	Elastomull® Haft 4 m x 12 cm	box of 10
59218	45477-00	Elastomull® Haft 20 m x 8 cm	box of 1
59219	45478-00	Elastomull® Haft 20 m x 10 cm	box of 1

## ELASTIC COHESIVE BANDAGES

- to fix dressings.
- ideal for supporting light joint fractures.
- this bandage does not require clips because perfectly adherent.

### TECHNICAL SPECIFICATIONS

Composition: 42% cotton, 29% viscose,  
29% polyamide, latex or latex free  
Width: 6 - 8 - 10 - 12 cm  
Length: stretched length 4 m  
Extensibility: approx. 50%



GIMA code	ELASTIC COHESIVE BANDAGE	Minimum order
34657	Cohesive bandage 4 m x 6 cm	box of 10
34658	Cohesive bandage 4 m x 8 cm	box of 10
34659	Cohesive bandage 4 m x 10 cm	box of 10
34660	Cohesive bandage 4 m x 12 cm	box of 10
34661	Cohesive bandage 20 m x 6 cm	box of 1
34662	Cohesive bandage 20 m x 8 cm	box of 1
34663	Cohesive bandage 20 m x 10 cm	box of 1
GIMA code	ELASTIC COHESIVE BANDAGE - LATEX FREE	Minimum order
59201	Cohesive bandage 4 m x 8 cm	box of 10
59202	Cohesive bandage 4 m x 10 cm	box of 10
59206	Cohesive bandage 20 m x 8 cm	box of 1
59207	Cohesive bandage 20 m x 10 cm	box of 1

## COHESIVE BANDAGES

### ELASTIC COHESIVE BANDAGES

Cohesive bandage with instantaneous and lasting fixation.

It adheres only to itself and not to the skin, hair or clothing.

Doesn't slip, is air-permeable, with stretchability of approx 115%.

Comfortable, well tolerated by skin, it adapts perfectly to part to be treated.

Versatile to use, easy to apply, permits free movement. Made in Italy.



GIMA code	COHESIVE BANDAGE	Minimum order
34710	Cohesive bandage size 4 m x 6 cm	box of 72 pcs
34711	Cohesive bandage size 4 m x 8 cm	box of 72 pcs
34712	Cohesive bandage size 4 m x 10 cm	box of 36 pcs
34713	Cohesive bandage size 4 m x 12 cm	box of 36 pcs

## ELASTIC COLOUR COHESIVE BANDAGES - EXTENSIBILITY 90%

Cohesive bandages through microfine latex dots

- for fixing dressings
- ideal for supporting joint treating light fractures
- this bandage does not require clips because it remains well-attached to itself.

### TECHNICAL SPECIFICATIONS

Composition: 42% cotton, 29% viscose,  
28% polyamide, 1% elasthan and latex  
Width: 6 - 8 - 10 cm Length: stretched length 4 m  
Extensibility: approx. 90%

### COHESIVE COLOUR BANDAGE

Size	Green	Blue	Red	Yellow	Colours*	Minimum order
4 m x 6 cm	-	34665	34666	-	34668	box of 10
4 m x 8 cm	34669	34670	34671	34672	34673	box of 10
4 m x 10 cm	34674	34675	34676	-	34678	box of 10

\*Mix 2 bandages x 5 colours (red, green, blue, yellow, white)



Cohesive through microfine latex dots

## PREVITNT COHESIVE NON WOVEN ELASTIC BANDAGES

### PREVITNT NON WOVEN ELASTIC BANDAGES

For fixing dressings.

Ideal for supporting joints, treating light fractures.

This bandage does not require clips because it remains well-attached to itself.

Particularly suitable for use on joints, for sports and veterinary use.

Composition: 85% polypropylene - 15% spandex and latex.

Extensibility: approx 100%.

### COHESIVE COLOUR NON WOVEN BANDAGE

Size	Blue	Red	Colours*	Minimum order
4.5 m x 7.5 cm	34734	34735	34736	box of 10
4.5 m x 10 cm	34738	34739	34740	box of 10

\*Mix 2 bandages x 5 colours (red, green, blue, yellow, skin)



## TENSOPLAST® ELASTIC ADHESIVE BANDAGES



**TENSOPLAST® BANDAGES**  
Elastic adhesive bandage. High quality elastic fabric, soft edges and porous adhesive mass. Yellow center line. It provides strong support and compression in traumatology and phlebological disease. Stretched length 4.5 m. Multilanguage box: GB, FR, IT, ES, DE, PT, GR, NL, SE.



GIMA code	BSN code	TENSOPLAST® BANDAGES
59250	71545-00	TENSOPLAST® 4.5 m x 5 cm
59251	71546-00	TENSOPLAST® 4.5 m x 7.5 cm
59252	71547-00	TENSOPLAST® 4.5 m x 10 cm

## GAUZE BANDAGES

For fixing dressing and for absorption of exudates. 100% cotton wool. Latex free. Made in Europe.



GIMA code	Threads	GAUZE BANDAGES - DISPOSABLE	Minimum order
34840	20	Gauze bandage 3.5 m x 5 cm	box of 12
34841	20	Gauze bandage 3.5 m x 7 cm	box of 10
34842	20	Gauze bandage 3.5 m x 10 cm	box of 6
34844	20	Gauze bandage 5 m x 5 cm	box of 100
34846	20	Gauze bandage 5 m x 7 cm	box of 100
34847	20	Gauze bandage 5 m x 10 cm	box of 100

## FIXATION ELASTIC BANDAGES

For fixing dressing, for support and light compression. Its characteristic crepe like touch enables the bandage to remain well-attached to itself. Well-tolerated by the skin, it ensures a high level of breathing. Washable at 60°C. Made of 99% cotton - 1% lycra. Made in Europe.



GIMA code	PREVICREPE S FIXATION ELASTICATED BANDAGES - 75 g <sup>2</sup>	Minimum order
34725	Previcrepe bandage 4 m x 5 cm	box of 10
34726	Previcrepe bandage 4 m x 7 cm	box of 10
34727	Previcrepe bandage 4 m x 10 cm	box of 10
34728	Previcrepe bandage 4 m x 15 cm	box of 10

## ELASTICATED BANDAGES

Elasticated **non adhesive** bandages for containment, individually cellophane wrapped, in a box. Non adhesive bandages are made of 65% cotton and 35% polyamide fibre. Provided with clasp. Made in Italy.



GIMA code	ELASTICATED BANDAGES	Minimum order
34720	Bandage size 4.5 m x 5 cm	box of 20 pcs
34721	Bandage size 4.5 m x 7 cm	box of 20 pcs
34722	Bandage size 4.5 m x 10 cm	box of 20 pcs

## ELASTICATED ADHESIVE BANDAGES

Elasticated **adhesive** bandages for containment, individually cellophane wrapped, in a box. Adhesive bandages are made of 99.7% cotton and 0.3% polyamide. Made in Switzerland.



GIMA code	ELASTICATED ADHESIVE BANDAGES
34730	Adhesive bandage size 4.5 m x 6 cm
34731	Adhesive bandage size 4.5 m x 8 cm
34732	Adhesive bandage size 4.5 m x 10 cm

## HYPOR-PLAST

**Extensible adhesive bandage**  
White extensible non-woven 100% polyester bandage roll. Extremely breathable and conformable. Hypoallergenic, reliable skin friendly acrylic adhesive.

**Indications:** suitable to fix dressings and other medical devices.

GIMA code	EXTENSIBLE ADHESIVE BANDAGE
34863	roll m 10 x 5 cm
34864	roll m 10 x 10 cm
34865	roll m 10 x 15 cm



## EMOCONTROL

• **34782 EMOCONTROL**  
Emocontrol is an easy, quick and effective elastic bandage for injuries and small haemorrhages. Length 4.5 m, width 10 cm with a 10x10 cm pad and 2 clips. English and Italian instructions. Made in Italy.



## ZINC-OINTMENT BANDAGE



- 34715 ZINC-OINTMENT ELASTIC BANDAGE 5 m x 10 cm
  - 34717 ZINC-OINTMENT ELASTIC BANDAGE 10 m x 10 cm
- Homogeneously soaked in zinc ointment ready for use and stretchable (in length).  
Each band is packed in sealed aluminium foil bag and cardboard box.  
Made in Italy.

### TEXTILE COMPOSITION

Viscose 71% - Polyamide 29% - Soaked with zinc oxide, gelatine, glycerin, propyl-hydroxybenzoate, methyl-hydroxybenzoate, water. Elasticity: 60% (±10%)

## PREVIZINC A and E

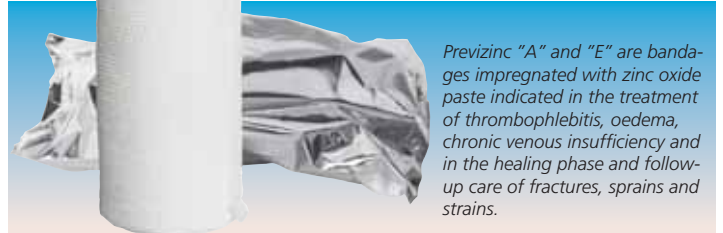

Previzinc "A" and "E" are bandages impregnated with zinc oxide paste indicated in the treatment of thrombophlebitis, oedema, chronic venous insufficiency and in the healing phase and follow-up care of fractures, sprains and strains.

GIMA code	PREVIZINC "A" INELASTIC BANDAGES	Minimum order
34714	Previzinc "A" 6 m x 8 cm	box of 10
34716	Previzinc "A" 5 m x 10 cm	box of 10
PREVIZINC "E" ELASTIC BANDAGES		
34718	Previzinc "E" 6 m x 8 cm	box of 10
34719	Previzinc "E" 5 m x 10 cm	box of 10

### TEXTILE COMPOSITION

Previzinc A: 100% cotton zinc oxide paste  
Previzinc E: 54% polyamide, 46% viscose zinc oxide paste

## PLATRIX® HIGH QUALITY PLASTER OF PARIS BANDAGES



**PLATRIX® PLASTER OF PARIS**  
High quality plaster of Paris bandages. Economic thanks to the high strength and the minimal plaster loss.  
Multilanguage box: GB, FR, IT, ES, DE, NL.

GIMA code	BSN code	PLATRIX® PLASTER OF PARIS	Minimum order
34686	71996 - 05	Platrix® 2 m x 15 cm	box of 40
34688	71996 - 14	Platrix® 3 m x 20 cm	box of 20
34691	71996 - 28	Platrix® 4 m x 20 cm	box of 20

## P.O.P. (PLASTER OF PARIS) BANDAGES

### PLASTER OF PARIS BANDAGES

Absorbent 100% cotton gauze 170 threads/cm<sup>2</sup> complying with British Pharmacopoeia requirements.

GIMA code	CELLONIT - PLASTER OF PARIS BANDAGE	Minimum order
34692	P.O.P. Bandage 2 m x 10 cm	box of 100
34693	P.O.P. Bandage 2 m x 15 cm	box of 50
34694	P.O.P. Bandage 2 m x 20 cm	box of 50
34695	P.O.P. Bandage 2.7 m x 10 cm	box of 80
34696	P.O.P. Bandage 2.7 m x 15 cm	box of 40
34697	P.O.P. Bandage 2.7 m x 20 cm	box of 40

Individually packed in a plastic bag and cardboard box



## OSCILLATING PLASTER SAW



59100

**SCHREIBER** INSTRUMENTE

Made in Germany

- 59100 SG - 600 PLASTER SAW
- 59101 SAW BLADE Ø 50 mm
- 59102 SAW BLADE Ø 65 mm

German made professional plaster saw, ideal for cutting plasters and synthetic bandages. Adjustable oscillating speed.

### STANDARD ACCESSORIES

Saw blade Ø 50 mm  
Saw blade Ø 65 mm  
One pair of wrenches  
Locking screw  
Fixation ring  
User manual: GB, IT, ES  
(DE on request)



59101



59102

### TECHNICAL SPECIFICATIONS

Voltage:	220-240 V, 50-60 Hz
Power:	250 W
Strokes:	12,000 - 21,000 oscillations/min
Length without cord:	340 mm
Weight with/without cable:	1.3/1.7 Kg
Noise:	68-82 dB
Cord length:	4.5 m
IP code:	IP2X

## COTTON GAUZE SWABS



CE 0373

34772      34790-1-2

GIMA code	Plies	Threads	GAUZES - NON STERILE	Minimum order
34770	16	20	Cotton gauze swab 5x5 cm	pack of 100
34771	16	20	Cotton gauze swab 7.5x7.5 cm	pack of 100
34772	16	20	Cotton gauze swab 10x10 cm	pack of 100
34773	12	20	Cotton gauze swab 10x20 cm	pack of 150
34790		20	Cotton gauze pad 10x10 cm - 1 kg	1 pack
34791		20	Cotton gauze pad 20x20 cm - 1 kg	1 pack
34792		20	Cotton gauze pad 30x30 cm - 1 kg	1 pack

## GAUZE SWABS: COTTON, NON-WOVEN

Gauze swabs pure cotton, 20 threads, yarn 40/40, folded and hemmed without X-ray thread, non-sterile.  
 Non woven swabs, 30% polyester, 70% viscose 30 g/m<sup>2</sup> folded and hemmed without X-ray thread.  
 Carton of 10 packs of 100.



Cotton	Plies	Non Woven	Plies	GAUZE SWABS NON STERILE	Minimum order
35005	16	35010	4	Size 5x5 cm	box of 1,000 (10 packs of 100)
35006	12	35011	4	Size 7.5x7.5 cm	box of 1,000 (10 packs of 100)
35007	16	35012	4	Size 10x10 cm	box of 1,000 (10 packs of 100)

## COTTON GAUZE SWABS - STERILE



CE 0476

34762      34761      34760

34764      34763

GIMA code	Threads	COTTON GAUZE SWABS - STERILE Made in Italy	Minimum order
34760	12/8	Size 10x10 cm	carton of 150 bags of 25 pcs
34761	12/8	Size 15x15 cm	carton of 100 bags of 25 pcs
34762	12/8	Size 20x20 cm	carton of 100 bags of 25 pcs
34763	12/8	Size 18x40 cm	carton of 50 box of 12 pcs
34764	12/8	Size 36x40 cm	carton of 50 box of 12 pcs

## NON WOVEN GAUZE SWABS - STERILE



CE 0476

35025      35028      35029

GIMA code	NON WOVEN GAUZE SWABS - STERILE Made in Italy	Minimum order
35025	Size 10x10 cm	carton of 100 bags of 25 pcs
35028	Size 18x40 cm	carton of 30 box of 12 pcs
35029	Size 36x40 cm	carton of 30 box of 12 pcs

## COTTON GAUZE SWABS - STERILE



100% cotton gauze, 17 threads / 59 cm<sup>2</sup>, according to European Pharmacopoeia and EN 14079. Each dispenser contains sterile packs of 5 gauze swabs.

CE 0373

35035      35037      35039      35038

GIMA code	Plies	Threads	GAUZE SWABS - STERILE	Minimum order
35035	12	17	5x5 cm	dispenser of 350 (70 packs of 5 swabs)
35036	12	17	5x5 cm - X-ray	dispenser of 350 (70 packs of 5 swabs)
35037	12	17	7.5x7.5 cm	dispenser of 250 (50 packs of 5 swabs)
35038	12	17	7.5x7.5 cm - X-ray	dispenser of 250 (50 packs of 5 swabs)
35039	12	17	10x10 cm	dispenser of 150 (30 packs of 5 swabs)
35040	12	17	10x10 cm - X-ray	dispenser of 150 (30 packs of 5 swabs)

## COTTON GAUZE BALLS - STERILE



CE 0373 100% cotton gauze, 20 threads / 59 cm<sup>2</sup> according to European Pharmacopoeia and EN 14079. Each dispenser contains sterile packs of 5 gauze balls.

Pack of 5

GIMA code	Threads	GAUZE BALLS - STERILE	Minimum order
35045	20	Gauze balls Ø 30 mm	dispenser of 250 (50 pack of 5)
35046	20	Gauze balls Ø 40 mm	dispenser of 200 (40 pack of 5)
35047	20	Gauze balls Ø 50 mm	dispenser of 300 (60 pack of 5)

## COTTON GAUZE BALLS



34780      34781

GIMA code	COTTON GAUZE BALLS	Minimum order
34780	Cotton gauze balls Ø 30 mm	100 pcs. (1 bag of 100)
34781	Cotton gauze balls Ø 50 mm	100 pcs. (1 bag of 100)

## COTTON GAUZE BALLS

Pure hydrophilic cotton gauze balls 20 threads, yarn 40/40, without X-ray thread, non sterile package. Carton of 10 bags of 100 balls.



35017      35016      35015

Cotton	Non Woven	GAUZE ROUND BALLS	Open size	Minimum order
35015	35020	Gauze ball Ø 15 mm	11x11 cm	1,000 pcs (10 bags of 100)
35016	35021	Gauze ball Ø 25 mm	12x15 cm	1,000 pcs (10 bags of 100)
35017	35022	Gauze ball Ø 50 mm	30x40 cm	1,000 pcs (10 bags of 100)

## GAUZE LAPAROTOMIC SPONGE

100% cotton gauze according to the European Pharmacopoeia and EN 14079, non sterile. X-ray detectable apx 60% Barium Sulphate.



GIMA code	Plies	Threads	LAPAROTOMIC SPONGE GAUZE	Minimum order
34775	4	17	Size 20x20 cm	box of 100
34776	4	17	Size 30x30 cm	box of 100
34777	4	17	Size 40x40 cm	box of 100
34778	4	17	Size 50x50 cm	box of 100

## DENTAL COTTON ROLLS

• 35000 COTTON ROLLS 1x3.8 cm  
100% cotton interior, soft, pliable, non-linting, non-irritating, highly absorbent up to 6 times their weight. Will not adhere to mucous membranes, maintains shape better when wet, non sterile. Minimum order: carton of 10 boxes of 1,000 pcs.



35000



## 100% COTTON WOOL



GIMA code	COTTON WOOL
34837	Cotton wool 100 g - box of 50 packs
34832	Cotton wool 250 g - box of 20 packs
34838	Cotton wool 1000 g - box of 10 packs

## STERILE ABSORBENT PADS



Multilanguage box:  
GB, FR, IT, ES,  
PT, DE, NL, SE

Ideal for situations where a great capacity of absorption is needed, such as bleedings and chronic wounds. Made of cellulose pulp, white and blue polypropilene and tissue paper.

GIMA code	STERILE ABSORBENT PADS	Minimum order
59402	10x10 cm	box of 60
59403	10x20 cm	box of 30
59404	20x20 cm	box of 30
59405	20x40 cm	box of 25

## 100% COTTON GAUZE ROLLS



59412

59411

59410

### GAUZE ROLLS

100% cotton gauze rolls with 20 threads sq cm according to European Pharmacopoeia and EN 14079. X-Ray detectable thread (approx. 60% barium sulphat) 80 cm width, folded 8 to 10 cm ply. Multilanguage box: GB, FR, IT, ES, PT, DE, NL, SE.

GIMA code	GAUZE ROLLS		Plies	Threads sq cm
	Extended width	Folded width		
59410	80 cm x 1 m	10 cm x 1 m	8	20
59411	80 cm x 2 m	10 cm x 2 m	8	20
59412	80 cm x 10 m	10 cm x 10 m	8	20

## 100% COTTON RIBBON GAUZE



- Latex and PVC free  
- Absorption of fluids inside cavities  
- Wound care during surgery

Multilanguage box:  
GB, FR, IT, ES,  
PT, DE, NL, SE

GIMA code	GIMA code	100% COTTON RIBBON GAUZE weight 33 g/sq. m 22 threads/sq. m	Minimum order
-	X-Ray*		
59420	59430	5 m x 1.25 cm	box of 24
59421	59431	5 m x 2.5 cm	box of 12
59422	59432	5 m x 5 cm	box of 12
59423	59433	5 m x 7.5 cm	box of 8
59424	59434	5 m x 10 cm	box of 6
59440	-	5 m x 1.25 cm - sterile	box of 60
59441	-	5 m x 2.5 cm - sterile	box of 30
59442	-	5 m x 5 cm - sterile	box of 26

\*X-Ray: approx. 60% barium sulphat contents

## 3M RESTON™ FOAM PAD

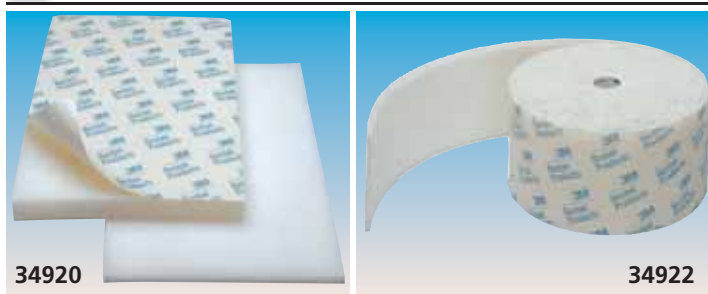

34920

34922

Self-adhering open cell foam designed to protect skin from splints, casts and prostheses. Not intended to be used as a pressure reducing device. It can also be used as a padding for beds and chairs. Can be cut, layered and shaped.



GIMA code	3M code	3M RESTON™ FOAM PAD	Minimum order
34920	1560	RESTON™ 30x20x1.1 cm	box of 10
34921	1561	RESTON™ 30x20x2.5 cm	box of 5
34922	1563	RESTON™ ROLL 10cmx5mx4mm	1 roll

## ADHESIVE DRESSING



GIMA code	STERILE - NON WOVEN ADHESIVE WOUND DRESSING HYPOALLERGENIC	Minimum order
34860	Sterile adhesive dressing 5x7 cm	box of 100 pcs
34861	Sterile adhesive dressing 8x10 cm	box of 50 pcs
34862	Sterile adhesive dressing 8x15 cm	box of 50 pcs

## STERILE ADHESIVE DRESSINGS



- **34848 OCULAR ADHESIVE DRESSING**  
Sterile, extremely absorbent ocular dressing on hypoallergenic permeable adhesive backing. Suitable for a safe and comfortable eye medication. Size 6.5x9.5 cm - box of 10 pcs
- **34845 STERILE ADHESIVE DEVICE for cannula fixation**  
Size 8x5.8 cm - box of 50 pcs

## ADHESIVE DRESSINGS



GIMA code	STERILE HYPOALLERGENIC ADHESIVE DRESSING WITH CENTRAL NON-WOUND-STICKING ABSORBANT PAD	Minimum order
34850	Sterile adh. dressing 7.2x5 cm	box of 8 pcs
34851	Sterile adh. dressing 10x10 cm	box of 6 pcs
34852	Sterile adh. dressing 10x15 cm	box of 4 pcs
34853	Sterile adh. dressing 10x8 cm	box of 50 pcs
34854	Sterile adh. dressing 10x15 cm	box of 50 pcs
GIMA code	HYPOALLERGENIC EXTENSIBLE NON WOVEN ADHESIVE DRESSING TO BE CUT, WITH HIGHLY ABSORBENT CENTRAL WOUND PAD	Minimum order
34855	Size 1 m x 6 cm	1 roll
34856	Size 5 m x 6 cm Recommended for sensitive skin	1 roll

## BWT ADHESIVE DRESSING



GIMA code	STERILE HYPOALLERGENIC ADHESIVE DRESSING WITH CENTRAL NON-WOUND-STICKING ABSORBANT PAD
34857	Sterile adh. BWT dressing 8x6 cm - box of 50 pcs
34858	Sterile adh. BWT dressing 10x10 cm - box of 50 pcs
34859	Sterile adh. BWT dressing 10x15 cm - box of 50 pcs

## SILK PLASTER ROLL

- **34787 SILK PLASTER ROLL 10 m x 2.5 cm - box of 12**
  - **34788 SILK PLASTER ROLL 10 m x 5 cm - box of 6**
- Silk surgical tape, white colour.

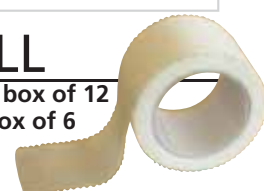

## PLASTER ROLLS



Each roll is supplied with a plastic roll cover except code 34798

PLASTER ROLLS - MADE IN ITALY			
Skintone fabric	Hypoallergenic Non woven	Size	Minimum order
34803	34804	5 m x 2.5 cm	box of 12 rolls
-	34798	9.14 m x 2.5 cm	box of 12 rolls
34806	34807	5 m x 5 cm	box of 6 rolls
34799	Shop Display: for showing up to 88 boxes (32 x 25 xh 63 mm)		

## NON WOVEN PAPER TAPE ROLL



GIMA code	NON WOVEN PAPER TAPE ROLL HYPOALLERGENIC ADHESIVE	Minimum order
34795	Tape roll h 25 mm x 5 m	box of 12 pcs
34796	Tape roll h 25 mm x 9.14 m	box of 12 pcs
34797	Tape roll h 50 mm x 9.14 m	box of 6 pcs

## 3M TAPES: MICROPOR<sup>™</sup>, MEDIPORE<sup>™</sup>, DURAPORE<sup>™</sup>, TRANSPOR<sup>™</sup>

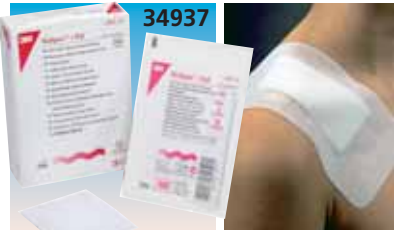

A latex-free, hypoallergenic paper tape that is gentle to the skin and doesn't leave adhesive upon removal. Highly breathable and economical. Can be used on wet skin.



GIMA code	3M code	3M MICROPOR <sup>™</sup> PAPER TAPES	Minimum order
34904	1530-0	MICROPOR <sup>™</sup> - h 12.5 mm x 9.14 m	box of 24 rolls
34905	1530-1	MICROPOR <sup>™</sup> - h 25 mm x 9.14 m	box of 12 rolls
34906	1530-2	MICROPOR <sup>™</sup> - h 51 mm x 9.14 m	box of 6 rolls
34907	1530-3	MICROPOR <sup>™</sup> - h 76 mm x 9.14 m	box of 4 rolls

Latex-free, hypoallergenic soft cloth tape. Gentle, breathable and easy-tear. Excellent cross and diagonal stretch to accommodate swelling and body movements. Available also with unique non-adherent pad.

GIMA code	3M code	3M MEDIPORE <sup>™</sup> SOFT CLOTH TAPES and 3M MEDIPORE <sup>™</sup> + PAD	Minimum order
34930	2991-1	MEDIPORE <sup>™</sup> - h 50 mm x 10 m	box of 1 roll
34931	2991-2	MEDIPORE <sup>™</sup> - h 100 mm x 10 m	box of 1 roll
34932	2991-3	MEDIPORE <sup>™</sup> - h 150 mm x 10 m	box of 1 roll
34933	2991-4	MEDIPORE <sup>™</sup> - h 200 mm x 10 m	box of 1 roll
34936	3562E	MEDIPORE <sup>™</sup> + PAD - 5x7 cm	box of 25 pcs
34937	3566E	MEDIPORE <sup>™</sup> + PAD - 10x10 cm	box of 25 pcs
34938	3569E	MEDIPORE <sup>™</sup> + PAD - 10x15 cm	box of 25 pcs
34939	3570E	MEDIPORE <sup>™</sup> + PAD - 10x20 cm	box of 25 pcs



A silk tape with a latex-free, hypoallergenic adhesive that offers high strength and adhesion to skin.



GIMA code	3M code	3M DURAPORE <sup>™</sup> SILK TAPES	Minimum order
34925	1538-1	DURAPORE <sup>™</sup> - h 25 mm x 9.14 m	box of 12 rolls
34926	1538-2	DURAPORE <sup>™</sup> - h 51 mm x 9.14 m	box of 6 rolls



Latex-free, hypoallergenic, transparent and perforated plastic tape that offers strong adhesion. Elastic and water-resistant.

GIMA code	3M code	3M TRANSPOR <sup>™</sup> PLASTIC TAPES	Minimum order
34941	1527-1	TRANSPOR <sup>™</sup> - h 25 mm x 9.14 m	box of 12 rolls
34942	1527-2	TRANSPOR <sup>™</sup> - h 51 mm x 9.14 m	box of 6 rolls

## BSN TAPES: LEUKOPOR<sup>®</sup>, LEUKOPLAST<sup>®</sup>, HYPAFIX<sup>®</sup>



The gentle tape for highly sensitive skin. For the fixation of dressings of all types and sizes. Non woven fabric and skin friendly adhesive mass.

GIMA code	BSN code	LEUKOPOR <sup>®</sup>	Minimum order
59501	02454-00	LEUKOPOR <sup>®</sup> 25 mm x 9.2 m	box of 12 rolls
59502	02455-00	LEUKOPOR <sup>®</sup> 50 mm x 9.2 m	box of 6 rolls



Highly adhesive tape for normal skin indicated when a strong adhesion is needed. Viscose fabric coated with traditional adhesive mass (natural rubber).

GIMA code	BSN code	LEUKOPLAST <sup>®</sup>	Minimum order
59504	01532-00	LEUKOPLAST <sup>®</sup> 25 mm x 5 m	box of 12 rolls
59505	01534-00	LEUKOPLAST <sup>®</sup> 50 mm x 5 m	box of 6 rolls



Non woven dressing retention sheet for the retention of dressings especially on highly contoured and frequently moved parts of the body. Conformable non woven fabric coated with a polyacrylic adhesive mass



Pad not included

GIMA code	BSN code	HYPAFIX <sup>®</sup>	Minimum order
59510	71443-01	HYPAFIX <sup>®</sup> 50 mm x 10 m	box of 1
59511	71443-02	HYPAFIX <sup>®</sup> 100 mm x 10 m	box of 1
59512	71443-03	HYPAFIX <sup>®</sup> 150 mm x 10 m	box of 1
59513	71443-04	HYPAFIX <sup>®</sup> 200 mm x 10 m	box of 1

## 3M STERI-STRIP™ - SKIN CLOSURE STRIPS

Adhesive skin closures made of non-woven backing coated with a pressure-sensitive hypoallergenic adhesive. Sterile, breathable and comfortable to wear.



34912



34912

STERI-STRIP™

### ELASTIC STERI-STRIP™

Stretches with body movement or edema. Mostly suited for special applications (e.g. joints) or plastic surgery. Skin tone.



GIMA code	3M code	3M REINFORCED STERI-STRIP™ - sterile - skin closure	Minimum order
34909	R1540	STERI-STRIP™ - 3x75 mm	50 bags of 5 strips
34910	R1541	STERI-STRIP™ - 6x75 mm	50 bags of 3 strips
34908	R1542	STERI-STRIP™ - 6x38 mm	50 bags of 6 strips
34911	R1546	STERI-STRIP™ - 6x100 mm	50 bags of 10 strips
34913	R1549	STERI-STRIP™ - 12x50 mm	50 bags of 6 strips
34912	R1547	STERI-STRIP™ - 12x100 mm	50 bags of 6 strips
34914	R1548	STERI-STRIP™ - 25x125 mm	25 bags of 4 strips

GIMA code	3M code	3M ELASTIC STERI-STRIP™ - sterile	Minimum order
34987	E4540	STERI-STRIP™ - 3x75 mm	50 bags of 5 strips
34988	E4541	STERI-STRIP™ - 6x75 mm	50 bags of 3 strips
34989	E4542	STERI-STRIP™ - 6x38 mm	50 bags of 6 strips
34990	E4546	STERI-STRIP™ - 6x100 mm	50 bags of 10 strips
34991	E4549	STERI-STRIP™ - 12x50 mm	50 bags of 6 strips
34992	E4547	STERI-STRIP™ - 12x100 mm	50 bags of 6 strips
34993	E4548	STERI-STRIP™ - 25x125 mm	25 bags of 4 strips

## SUTURE STRIPS

• 34997 STERILE SUTURE STRIPS - box of 8  
Sterile adhesive strips for cut and wound suture.  
Cut to measure.  
Dermatologically tested.  
It contains 5 small strips (3x75 mm) and 3 medium strips (6.4x80 mm).  
Multilanguage box: GB, FR, IT, ES, DE.



34997

## SOOTHING PATCH

• 34830 PREVIDOL SOOTHING PATCH  
9x14 cm - pouch of 5  
Previdol is a Medical Device patch adjuvant in the treatment of pains in the joints and the muscular-skeletal system. It acts on the affected part, keeping the skin protected and helping to give relief in presence of pain. To improve the cutaneous tolerability of the patch, some plant extracts like Arnica Montana, Devil's Claw and Boswellia were inserted, as well as some essential oils of Mint and Menthol to give a pleasant fragrance. Box: GB, IT.



## 3M SKIN CARE SOLUTIONS - CAVILON™

A complete range of barrier products to protect the skin from body fluids and friction. Cavilon™ products create on the skin a highly breathable, long lasting transparent coating to prevent maceration and trauma. Alcohol-free, hypoallergenic and non irritating, can be used on broken skin and under any tapes and dressing.

GIMA code	3M code	3M CAVILON™	Minimum order
34974	3346E	Cavilon™ no sting barrier film - spray 28 ml	box of 12
34973	3346P	Cavilon™ no sting barrier film - spray 28 ml	box of 1
34975	3392G	Cavilon™ durable barrier cream 92 g	1 dispenser
34976	9274	Cavilon™ continence care wipes	12 boxes of 8

3M CAVILON™ NO STING BARRIER FILM  
Up to 72 hours of protection for peri-wound and peri-ostomy skin.



3M CAVILON™ DURABLE BARRIER CREAM  
Zinc-oxide free barrier cream for continence care. Apply twice a day.

3M CAVILON™ CONTINENCE CARE WIPES  
«All in 1» wipes for cleansing, moisturizing and protecting the skin.



34974

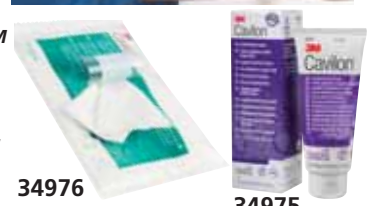

34976

34975

## ADHESIVE PLASTERS AND SPRAY - PLASTER DISPENSER



34817

34814

34809

34823

GIMA code	HYPOALLERGENIC ADHESIVE PLASTERS	Minimum order
34809	Water resistant - 19x72 mm	2,000 (100 boxes of 20)
34814	Water resistant - 4 mixed sizes	2,000 (100 boxes of 20)
34817	Sensitive skin - 5 mixed sizes	3,200 (80 boxes of 40)
34823	Spray plaster - bottle of 30 ml	box of 12



34828

Made in Italy

34826

Size 230x120x38 mm

• 34826 PLASTER DISPENSER - with 2 refills (one each type)  
• 34827 REFILL 42 TEXTILE PLASTERS 19x72 mm - box of 6  
• 34828 REFILL 38 TEXTILE PLASTERS 25x72 mm - box of 6  
Dispenser for adhesive plasters ready for use. It allows operator to extract plaster with one hand and apply directly on the wound. Transparent cover protects plaster and shows residual quantities. Lockable and with fixing wall kit included.

## 3M TEGADERM™ DRESSINGS



### TEGADERM™

Transparent, sterile waterproof dressing. Highly breathable. Frame style for easy application also available in non-sterile roll.

### TEGADERM™ + PAD

Transparent, sterile waterproof dressing. Highly breathable. Frame style for easy application. With a non-adherent absorbent PAD. Ideal for surgical wounds.



GIMA code	3M code	3M TEGADERM™ FILM	Minimum order
34900	1624W	TEGADERM™ - 6x7 cm - sterile	box of 100 pcs.
34901	1626W	TEGADERM™ - 10x12 cm - sterile	box of 50 pcs.
34902	1627	TEGADERM™ - 10x25 cm - sterile	box of 20 pcs.
34903	1628	TEGADERM™ - 15x20 cm - sterile	box of 10 pcs.
34899	16004	TEGADERM™ - 10 cmx10 cm non sterile	1 roll

GIMA code	3M code	3M TEGADERM™ PAD	Minimum order
34895	3582	TEGADERM™ + PAD 5x7.2 cm - sterile	box of 50 pcs.
34896	3586	TEGADERM™ + PAD 9x10 cm - sterile	box of 25 pcs.
34897	3589	TEGADERM™ + PAD 9x15 cm - sterile	box of 25 pcs.
34898	3591	TEGADERM™ + PAD 9x25 cm - sterile	box of 25 pcs.

## 3M VASCULAR ACCESS SOLUTIONS - TEGADERM™ IV

A complete range of sterile, waterproof, highly-breathable transparent film dressings to protect IV sites from water, virus and bacteria. With antifriction backing and reinforced non-woven borders for longer wearing time and minimized catheter dislodgement risk.



### TEGADERM™ IV

A cost-effective solution for peripheral and central vascular lines with strong hold and gentle removal.

### TEGADERM™ IV ADVANCED

A reinforced, 100% waterproof, advanced solution for better securement and longer wearing time.

GIMA code	3M code	3M TEGADERM™ IV - STERILE	Minimum order
34945	1633	7x8.5 cm - for peripheral lines	box of 100
34946	1635	8.5x10.5 cm - for central lines	box of 50

GIMA code	3M code	3M TEGADERM™ IV ADVANCED - STERILE	Minimum order
34947	1683	6.5x7 cm for peripheral lines	box of 100
34948	1685	8.5x11.5 cm for central lines	box of 50

## 3M SOLUTIONS FOR CHRONIC WOUNDS

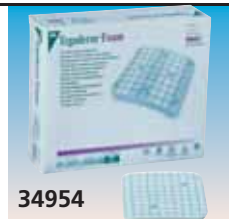

34968

34969

34954

34957

34955

### TEGADERM™ HYDROCOLLOID

Sterile hydrocolloid dressing for low to moderate draining wounds. Also available in sacral shape with highly breathable waterproof border.

### TEGADERM™ HIGH PERFORMANCE FOAM

Sterile, multi-layer foam dressing that combines high absorbency with high breathability to reduce the risk of wound maceration. Well suited for changing levels of exudate to maintain moisture balance for optimal wound healing. Highly breathable and waterproof, also available in heel/elbow shape with adhesive border and simplified application system

GIMA code	3M code	3M TEGADERM™ HYDROCOLLOID	Minimum order
34968	90002	HYDROCOLLOID™ 10x10 cm square	box of 5
34969	90007	HYDROCOLLOID™ 16x17 cm sacral	box of 6

GIMA code	3M code	3M TEGADERM™ FOAM - non adhesive or adhesive dressing	Minimum order
34954	90601	TEGADERM™ FOAM - 10x10 cm	box of 10
34955	90604	TEGADERM™ FOAM - 9x9 cm for tracheostomy	box of 10
34957	90619	TEGADERM™ FOAM ADHESIVE for heel and elbow - 14x14 cm	box of 5



### TEGADERM™ ALGINATE

High integrity, gel forming alginate dressing for moderate to heavily exuding wounds. Compact and comfortable.

### TEGADERM™ ALGINATE AG

Antimicrobial, highly absorbent wound dressing with calcium alginate, carboxymethyl cellulose and ionic silver complex. To prevent and treat wound infections.



### TEGADERM™ HYDROGEL

Preservative-free hydrogel wound filler, easy to apply. Formulated to help provide a moist wound healing environment. Single use tube.



GIMA code	3M code	3M TEGADERM™ ALGINATE and ALGINATE AG	Minimum order
34964	90112	TEGADERM™ ALGINATE - 10x10 cm	box of 10
34965	90312	TEGADERM™ ALGINATE AG - 10x10 cm	box of 10

GIMA code	3M code	3M TEGADERM™ HYDROGEL	Minimum order
34972	91110	TEGADERM™ HYDROGEL 15 g	box of 10

## BURNFREE® - BURN CARE PRODUCTS



A complete range of burn care products with superior benefits:

- dissipates heat on contact
- cools the burn site, relieves pain, calms the burn victim, helps stop the burn process
- covers the burn, helps to prevent contamination
- accommodates swelling or the need to flex joints thanks to elastic texture

### Sterile burn and wounds dressings

Made of a soft open-cell, non-adherent, inert foam, saturated with Burnfree® gel, does not leave residues imbedded in the wound.

### Pain relieving gel

Ideal for all minor burns (including sunburns), cuts and abrasions, available in bottle or single use dose 3.5 g. Without lidocaine, which makes it suitable for children.

GIMA code	BURNFREE® PRODUCTS
34869	Burn Dressing - 5x5 cm - box of 120 pcs
34870	Burn Dressing - 5x15 cm - box of 10 pcs
34871	Burn Dressing - 10x10 cm - box of 10 pcs
34872	Burn Dressing - 20x20 cm - box of 5 pcs
34873	Burn Dressing - 30x30 cm - box of 20 pcs
34875	Pain Relieving Gel - bottle 120 ml
34883	Pain Relieving Gel - 3.5 g sachets - box of 20 pcs
34882	Pain Relieving Gel - 3.5 g sachets - box of 1,000 pcs
34878	Burn Kit (2 sterile dressing 5x15 cm and 2 10x10 cm, 1 gel bottle 120 ml, 20 gel sachets 3.5g and 2 rollers gauzes)

## HYPOTHERMIC BLANKET

### • 34086 HYPOTHERMIC BLANKET

Reflects and retains over 80% of radiated body heat to keep a person warm and protected even at subzero temperature. Waterproof, reusable, wind proof, lightweight.



Size  
200x150 cm

Made of polypropylene Fralom fibre coupled to a metallized polyethylene fibre.

Blanket colour may change in the time

## ISOTHERMIC COVER

### • 34085 EMERGENCY COVER

Suitable for protection against cold and heat. Silver side in keeps the warmth of the body, gold side out reflects sunbeams.



Radio transparent

Size: 160x210 cm.  
Weight: 67 g

## BURNFREE® - FIRE BLANKET

Bags with strap for easy transport (34880-1 only)

34879

Supplied with bag



34880

34881

### BURNFREE FIRE/TRAUMA BLANKETS

Provides physical protection from heat, fire and smoke. Cools and soothes burn area. Fire resistant, are a protective shield for a person trapped by fire.

GIMA code	Blanket Size	Weight
34879	91x76 cm	2.3 kg
34880	183x152 cm	6.9 kg - 15 lbs
34881	244x152 cm	10.9 kg

## FIRE RETARDANT BLANKET

### • 34087 FIRE RETARDANT BLANKET

Made in glass fibre. Can be used to extinguish small fires. Size: 150x180 cm



34087

## INSTANT ICE: SPRAY OR BAG IN TNT OR PE



- 34110 INSTANT ICE - TNT 14x18 cm bag (non woven fabric)
  - 34111 INSTANT ICE - PE 14x18 cm bag (polyethylene)
- minimum order: pack of 25 bags.

Icy-pack "instant ice" is recommended for cryotherapy. Excellent in case of traumas to soothe the pain and to prevent haematomas, swellings, etc.

### Easy and quick to use anywhere and anytime.

Press the bag to break the inner bubble and shake to mix contents. The blend you obtain drops temperature of the pack down. Activates at -6°C, reaches 0°C in 30 minutes (at environment temperature of 20 °C).

### • 34112 SPRAY INSTANT ICE - bottle 400 ml

Ecological, useful for small bruises, haematomas or trauma, in first aid or sport applications. Spray on the injured area at 20 cm distance. (see the reference temperature chart). Content: Ammonium nitrate + water.

## ANTIBACTERIAL HAND CLEANING GEL



### ANTIBACTERIAL HAND CLEANING GEL

Antibacterial hand cleaning gel, cleans the hands and prevents the settlement of bacteria.

It is effective against bacteria, virus, fungi.

No need of water. Gima range includes 4 sizes and 4 different flavours (neutral transparent, apple, strawberry, lemon).

GIMA code	ANTIBACTERIAL HAND CLEANING GEL	minimum order
36580	Antibacterial gel 85 ml tube - transparent	box of 48
36581	Antibacterial gel 85 ml tube - green - apple	box of 48
36582	Antibacterial gel 85 ml tube - red - strawberry	box of 48
36583	Antibacterial gel 85 ml tube - yellow - lemon	box of 48
36590	Antibacterial gel 500 ml bottle* - transparent	box of 15
36591	Antibacterial gel 500 ml bottle* - yellow - lemon	box of 15
36595	Antibacterial gel 1 l bottle* - transparent	box of 12
36597	Antibacterial gel 5 l bag - transparent	box of 4
33283	Dispenser pump for 36597	1

\*Each bottle includes dispenser pump

## MULTIUSI GEL

- 36646 MULTIUSI GEL - 50 ml - box of 24 tubes
- 36647 MULTIUSI GEL - 75 ml - box of 24 tubes
- 36645 MULTIUSI GEL - 65 ml - spray - box of 36 pcs.
- 36642 MULTIUSI GEL - 150 ml - box of 24 pcs.
- 36644 MULTIUSI GEL - 1000 ml\*
- 36692 DISPENSER PUMP - for 36644

Cleanser hygienic for hands without water. Ready-to-use product, which contains 62% ethyl alcohol for a rapid and effective hands disinfection. It has been studied to sanitize and clean hands without using water.

It dries fast and leaves hands soft and fresh. Its disinfecting power is combined with an effective skin-protecting action, it guarantees hygienic protection in few seconds. Made in Italy.

36644



\*Sold in box of 12 pcs, only 2 pieces come with dispenser pump

## BARRIER CREAM - HANDS PROTECTION

- 36578 BARRIER CREAM - 500 ml
- White barrier cream, enriched with vitamins and ingredients which protect the skin from everyday risks. It acts as an **invisible barrier** that allows regular perspiration and prevents from irritation, pricking, redness, cracking and from contact with liquids such as detergents, greases and oils. Waterproof: its film barrier resists even after several washing with water. Can be used many times during the day. The cream is also ideal to avoid skin's maceration due to the use of gloves. For professional use. Made in Italy.

36578



## SURGERY DISINFECTANT

- 36632 NEO STERIXIDINA SOAP - 1 l
- 36690 DISPENSER PUMP

Recommended for preparation of hands before surgical intervention and for complete washing of patients. Direct action towards bacteria Gram<sup>+</sup>, Gram<sup>-</sup>.

Made in Italy.

4% CHLORHEXIDINE

### CHEMICAL COMPOSITION

100 g contains: Chlorhexidine digluconate 4 g - Isopropyl alcohol 4 g - Coformulants - Depurated water as needed for 100g

Italian Health Ministry registration 18980



## MEDICAL SOAP

- 36629 MEDICAL SOAP - 0.5 l - box of 12
- 36630 MEDICAL SOAP - 1 l
- 36690 DISPENSER PUMP

Antiseptic liquid for disinfection of skin and hands. It is studied for people who need frequent washing as surgeons, medical and hospital attendants also before surgical operations.

2 dispenser pump every 12 bottles

Instruction: GB, IT.

Made in Italy.

Italian Health Ministry registration 19570



36629

36630

## DENTAL PROTECTION

- 36650 GERMOXID MOUTHWASH - 1 l with chlorhexidine

Specifically formulated to guarantee the highest hygienic standards and oral cavity disinfection. Chlorhexidine is the most widely used and effective germicidal agent and acts against Gram<sup>+</sup> and Gram<sup>-</sup> bacteria, giving an overall anti-plaque and anti-gingivitis action.

Germoxid with its anti-plaque action guarantees efficient and long-lasting protection up to 12 hours.

Its alcohol-free formula assures that neither gum irritation nor a burning sensation will be felt. It contains Aloe Vera in its formula: this is a particularly suitable extract for oral hygiene with high cicatrizing power.

Made in Italy.

36650



## NOVALCOL SKIN DISINFECTANT

- 36609 NOVALCOL - 250 ml - box of 12 bottles
- 36611 NOVALCOL - 1 l
- 36613 NOVALCOL - 3 l

Novalcol must be used pure before and after the injection, or in the preoperative cleaning of the patient (or for those confined to bed). Novalcol is non irritant and non inflammable. It does not stain or burn. Efficient against gram<sup>+</sup>, gram<sup>-</sup>. Instructions on the bottle in GB, IT.

CHEMICAL COMPOSITION	
Benzalkonium Chloride	0.1 g
O-phenilphenol	0.02 g
Isopropyl Alcohol, Coformulants, deperated water as needed to	100 g
Made in Italy.	

Italian Health Ministry  
Registration 13428

36611



36609

36613

## FLOW PACK WIPES

- 36627 FLOW PACK 20 WIPES

Disinfectant detergent perfumed wipes for hands and body disinfection. Active against bacteria to guarantee hygiene and total protection. Suitable to fight against effects of perspiration, eliminating bacteria that cause bad smells. Good for children and in case of insects bites. Ready to use, they do not stain and do not grease.

Minimum order: 1 display of 16 flow pack with 20 wipes

Italian Health Ministry. Registration 12671

36627



36606



36604

## HYDROGEN PEROXIDE

- 36604 OXYGENATED WATER (Hydrogen peroxide) - 250 ml - box of 12
  - 36606 OXYGENATED WATER (Hydrogen peroxide) - 1 l
- Hydrogen peroxide (3% diluted solution) 10 volumes. Colourless, odourless. 100% biodegradable. Made in Italy.

## ALCOHOL SWABS/PADS

- 36601 QUICKPAD DISPENSER

Fleece pads saturated with 70% Isopropyl Alcohol. The tight fitting lid prevents evaporations. Size 50x50x80 mm contains 150 pads, size: 44x44 mm.

U.S. and International Patents FDA Reg. #8010920

150 ALCOHOL SWABS



## DISINFECTANT WIPES

### DISINFECTANT WIPES

- 36625 tube of 100 wipes
  - 36626 box of 400 bags
- Active against bacteria are ideal for children since they do not burn. Indispensable in the house, the car, in sporting events. Indicated for the disinfection of:
- insect bites
  - skin before and after injections
  - disinfection of hands and other body parts.
- Instructions on the box in GB, IT.

Italian Health Ministry  
Registration 12671

36626



36625

CHEMICAL COMPOSITION	
100 g contain:	Benzalkonium Chloride 0.5% - O-phenilphenol 0.01% - Coformulants and water as needed to 100 g.
Made in Italy.	

## ALCOHOL SWABS/PADS

- 36598 ALCOMED PADS - box of 100
  - 36599 ALCOMED PADS - carton of 10,000 (100 boxes of 100 pads)
- Alcohol saturated pads with 70% isopropyl alcohol for skin preparation prior to injection.
- Bag size 50x50 mm, folded pad 32.5x30 mm, open pad 65x30 mm.

36598



## NaCl 0.9% B-BRAUN STERILE IRRIGATION SOLUTIONS



GIMA code	B-BRAUN code	B-BRAUN	Minimum order
36550	3570310	B-BRAUN ECOLAV® - 30 ml	box of 100
36551	3570350	B-BRAUN ECOLAV® - 100 ml	box of 20
36552	3570380	B-BRAUN ECOLAV® - 250 ml	box of 20
36554	3570110	B-BRAUN ECOTAINER® - 250 ml	box of 12
36555	3570130	B-BRAUN ECOTAINER® - 500 ml	box of 10
36558	3513576	B-BRAUN OMNIFLUSH® - 10 ml	box of 100

### ECOLAV®

The spray nozzle of Ecolav® allows a precise and direct irrigation of the target area by simply applying a slight pressure on the container, helping optimize the time for irrigation processes. Multilanguage manual and box: GB, FR, IT, ES, DE, PT, NL.

### ECOTAINER®

Ecotainer® non-drip pouring characteristics help reduce contamination risks during the irrigation process. Suggested for quick irrigation with high volume of solution. Multilanguage manual and label: GB, FR, IT, ES, DE, PT, NL, DK, FI, NO, SE.

### B-BRAUN OMNIFLUSH®

**PREFILLED FLUSH syringe 10 ml with NaCl 0.9% - box of 100 - EM-3513576**

The Omniflush® syringe is designed specifically to minimize unintended blood reflux into the catheter lumen thus reduces the risk of catheter blockage. With Omniflush® the fluid amount used for flushing can be reduced to the required minimum. For flushing of all intravenous accesses. Multilanguage manual and label: GB, FR, IT, ES, DE, PT, PL, CZ, BG, DK, EE, FI, GR, HU, LT, LV, NL, NO, RO, SK, SI, SE.



36558



36558

## SURGICAL SCRUB BRUSHES/SPONGES



36570

• **36570 SCRUB KIT - sterile - dispenser of 30 pcs**  
Sterile hand-cleaning hospital kit. It includes a scrub, a sponge and a plastic nail cleaner. Dry, without detergent. Sterilization method: ETO. Multilanguage label (blister and dispenser): GB, FR, IT, ES, DE, PT, PL, NL, GR, RU, Arab. Made in Italy.

All scrub kits are individually blistered in 30 pieces dispenser



36570



36571, 36572

• **36571 IODO-POVIDONE SCRUB KIT dispenser of 30 pcs - IT**  
Italian Health Ministry registration PMC 19575  
• **36572 IODO-POVIDONE SCRUB KIT dispenser of 30 pcs - Multilanguage\***  
*\*Label: GB, FR, ES, DE, PT, PL, NL, GR (blister and dispenser), PL, RU, Arab (blister only)*  
Same as 36570 with solution of PVP Iodine 7.5 g in 100 ml. Made in Italy.



36571



36572



36573, 36574

• **36573 CHLOREXIDINA SCRUB KIT dispenser of 30 pcs - IT**  
Italian Health Ministry registration PMC 19531  
• **36574 CHLOREXIDINA SCRUB KIT dispenser of 30 pcs - Multilanguage\***  
*\*Label: GB, FR, ES, DE, PT, NL, GR (blister and dispenser), PL, RU, Arab (blister only)*  
Same as 36570 with solution of Chlorhexidine Gluconate 20% 4 g in 100 ml Made in Italy.



36573



36574

## PERFECTION BRUSHES



STERILIZABLE IN AUTOCLAVE

• **25715 PERFECTION BRUSHES**  
Nylon brushes for cleaning before and after operation. These brushes are autoclavable (at 100°C for not more than 5 minutes) and can be stored in any standard brush dispenser in hospitals. Resistant and reliable. Handle in PP. Supplied in boxes of 12 units.

## IODO-POVIDONE ANTISEPTIC

- 36614 IODO-POVIDONE ANTISEPTIC 125 ml
- 36608 IODO-POVIDONE ANTISEPTIC 500 ml
- 36619 IODO-POVIDONE ANTISEPTIC 1,000 ml

Wide spectrum disinfectant for the disinfection and cleaning of the skin in hospital wards with high risk of infection. Medical-Surgical Presidium n.19661. The range of action includes Gram<sup>+</sup> and Gram<sup>-</sup> germs, acid and acid resistant bacteria and virus. Its activity is maintained in the presence of organic materials. Label: GB, IT. Made in Italy.

IODO-POVIDONE  
10% IODINE

### CHEMICAL COMPOSITION

Each 100 ml contains: polyvinylpyrrolidone iodine 10 g, coformulants and purified water needed to 100 ml



36614

36608

36619

## CHLORHEXIDINE DISINFECTION LINE



14x20 cm wipe suitable for hands skin disinfection (bag 6x8 cm)

36638

36634

- 36637 GERMOXID SPRAY DISINFECTION - 100 ml - box of 12
- 36635 GERMOXID DISINFECTION - 250 ml - box of 12
- 36636 GERMOXID DISINFECTION - 1,000 ml - box of 12
- 36634 GERMOXID WIPE - 12 boxes of 10 wipes
- 36638 GERMOXID WIPE - box of 400 wipes

Germoxid is a ready-to-use disinfectant for skin that contains Chlorhexidine with long-lasting bactericidal action. Chlorhexidine has a proven broad-spectrum effectiveness against Gram<sup>+</sup> and Gram<sup>-</sup> bacteria. The molecular structure of Chlorhexidine is very similar to that one of epidermis proteins and it is therefore rapidly and constantly absorbed by the skin. Chlorhexidine is particularly suitable for skin disinfection. It is particularly safe for medical operators thanks to its high epidermis compatibility, it neither irritates the skin nor stains or burns. Available in 3 versions: liquid (250 or 1,000 ml), spray (spray dispenser allows a quick and efficient action and is eco-friendly) or wipes (ready-to-use disinfecting wet wipes containing chlorhexidine). Italian Health Ministry registration 11571



Label in GB, IT

36636

36635

36637

## BARRYCIDAL "30 PLUS": A WIDE-SPECTRUM DISINFECTANT



CE 0426

Manual in:  
GB, IT, FR, ES.

- 35761 BARRYCIDAL "30 PLUS" - diluted 5% - bottle 1 l
- 35759 BARRYCIDAL "30 PLUS" - diluted 5% - bottle 1.2 l

minimum order: box of 12 bottles  
minimum order: box of 6 bottles

Ready for use 1 or 1.2 l bottle with 10 cc measurer cap.

- 35763 BARRYCIDAL "30 PLUS" - concentrate, to be diluted - tube 224 ml
- 35764 BARRYCIDAL "30 PLUS" - concentrate, to be diluted - tank 3.785 l (1 Gallon)

Barrycidal 30 Plus is a water-based solution with glutaraldehyde and phenols, suitable to cleanse and disinfect surgical instruments and thermosensitive, non-autoclavable endoscopes, with good property to dissolve blood and organic traces. Colourless liquid emulsion. The product diluted by 5% is not classified as hazardous pursuant to the provisions set in Regulation 1272/2008 (CLP). Medical Device according to Class IIb - Directive 93/42 EEC.

**Tested action-spectrum in "clean" conditions:** bactericide (EN 13727 and EN 14561), fungicide (Candida Albicans, Aspergillus Niger; EN 13624 and EN 14562), mycobactericidal and tuberculocidal (Mycobacterium Avium, Mycobacterium Terrae; EN 14348 and EN 14563), virucidal (EN 14476).  
30 Plus concentrate acts in 15 min. if diluted by 5%, 60 min. if diluted by 2.5%. Diluted by 2.5% results in 9 l of ready to use product.

### CHEMICAL COMPOSITION

**30 Plus concentrate:** 100 ml contain: glutaraldehyde (<2%), 2-benzil-4-chlorophenol 4.5%, 2-phenylphenol 7%, coformulants and purified water.

**30 Plus standard:** contains less than 0.2% at 5% dilution glutaraldehyde, phenols, surfactants.



## DISINFECTANT POWDER

- 36639 GERMOCID PERACETIC POWDER - bag 16 g - box of 50 bags
- 36640 GERMOCID PERACETIC POWDER - box of 500 g

CE 0546

Cold sterilizer disinfectant: the peracetic acid which forms from the reaction of sodium percarbonate and tetracetylendiammine (which is obtained after dissolving the product into water) carries on an efficacious biocidal action against **spores, virus (HIV, HBV, HCV), bacteria, mycobacteria and fungi**. At the concentration of 0.3% it carries on **sterilization in 10 minutes**.

The product is active in 15 minutes from dissolution, solution remains active for max 24 hours. Suitable for a cold rapid sterilization and disinfection of endoscopes, surgical and dental instruments, transducer, etc. The product is active also in presence of organic materials.

In this case it is better to previously clean the device with suitable detergent, better if with enzymatic base.

It can also be used with automatic washing machines for endoscopes. No environmental impact: once in contact with discharge water, it degrades immediately into acetic acid, water, oxygen.

Chemical composition: peracetic acid precursors and coformulants. Made in Italy.



36640

## SPRAY DISINFECTANT

- 36620 GERMOCID SPRAY DISINFECTANT - 400 ml

minimum order: 12 pcs

Spray disinfectant with bactericidal power. Disinfects and deodorizes surfaces and objects of crowded and smoky areas (hospitals, classrooms, examination and surgery rooms, bathrooms, cars, trailers). Instructions on box in GB, IT.

### CHEMICAL COMPOSITION

100 g contain: O-phenilphenol 0.02 g; benzalkonium chloride 0.1 g. Coformulants and propellants as needed to 100 g. Made in Italy.

Italian Health Ministry registration 7604



36620

## BOXES FOR COLD STERILIZATION



35770



35772 autoclavable

- 35770 STERILIZATION BOX - 1.5 l (internal: 10x25.5xh 7.5 cm)
  - 35772 STERILIZATION BOX - 3 l (internal 18.3x29xh 9 cm) - autoclavable
- Useful plastic box, with an internal removable perforated instrument tray, specially developed for cold sterilization of medical instruments. White colour. Made in Italy.

## GERMOCID TABS

- 36622 GERMOCID TABS CHLORINE TABLETS - 1 kg

White round effervescent chlorine tablets for cleaning, disinfecting and deodorizing. The dilution of 1 tablet in 7-8 litres of water or 2 tablets if you need stronger disinfection allows to hygienize rubber, plastic or glass. Germocid tabs can be used for many other purposes:

wc sanitizing, dishwasher, floor cleaning and also for mopping bars, restaurants, hospitals. Rinsing required. Packed in 1 kg jar, containing approx: 300 tabs. Label/instruction in GB, IT. Made in Italy.



36622

## ENZYME-BASED DETERGENT

- 36618 ENZYME-BASED DETERGENT - 3 l

Medical device enzymatic based detergent for invasive surgical instruments. This clear liquid detergent is very useful to improve the cleaning of orthodontic and surgical instruments, glassware, plastic and metal objects. Also suitable for ultrasound cleaners. Dilute in 1 litre warm water, immerse the instruments for 10 minutes and rinse. Label/instruction in GB, IT. Made in Italy.

CE 0546

### CHEMICAL COMPOSITION

100 g contain: proteolytic enzymes 0.5 g, non-ionic surfactant agents 10-15 g, coformulants, water as needed to 100 g



36618

## MULTILAYER DECONTAMINATING MAT WITH ANTIBACTERIAL



- 36685 DECONTAMINATING MAT 45x90 - box of 5 - blue
- 36686 DECONTAMINATING MAT 60x90 - box of 5 - blue

### DECONTAMINATING MATS

Mats to be used in all environments that require total absence of contaminating agents and the preservation of high hygienic levels. GIMA mat, thanks to antibacterial glue captures and retains dust and bacteria and substantially reduces bacteria growth and spreading. A full length adhesive sheet on the bottom of the mat provides a firm grip to the floor. Easy removability without leaving any adhesive trace.

Each mat includes 30 numbered polythene sheets and a non-adhesive edge strip to allow easy removal of each used layer. Medical disposable device CE Classe 1 non-sterile. Packed in a stylish dispenser folder with handle for easy carriage and vertical storage. Each mat can be easily picked leaving the others perfectly stored. Total mat thickness: 1.5 mm. Box of 5 mats with 30 sheet each. On request (minimum 10 boxes) available in white or green and size 60x95 cm or 90x95 cm.

- 36693 DECONTAMINATING MAT 45x115 - box of 5 - blue
- 36694 DECONTAMINATING MAT 60x115 - box of 5 - blue
- 36695 DECONTAMINATING MAT 90x115 - box of 5 - blue
- 36696 DECONTAMINATING MAT 45x115 - box of 5 - white



## GERMOCID WIPES FOR SURFACES, MEDICAL DEVICES

- 36680 GERMOCID WIPES - 120 wipes - tube

Ready to use wipe, it contains a Chlorhexidine and Quaternary Ammonium Salt based alcoholic solution. With a fast and effective disinfectant action against Bacteria Gram<sup>+</sup> Gram<sup>-</sup> Yeasts, Moulds, Fungi, Tuberculous Mycobacteria (TBC). Lipophilic and hydrophilic Viruses (HIV - HVB - HVC). The product has a high detergent power and it quickly evaporates.

It is not inactivated by organic residuals.

Suitable for cleaning and disinfection of non-invasive medical devices and surfaces disinfection in medical and dental medical offices.

Wipe size: 200x240 mm.

CE 0546



36680

## GERMOCID BASIC SPRAY

### CHEMICAL COMPOSITION

100g of product contain	
Chlorhexidine digluconate	0.1 g
Benzalkonium chloride	0.1 g
Ethanol	45 g
2-Propanol	15 g
Coformulants	
and deperated water as needed for	100 g
Appearance: green liquid	
Smell: characteristic pine	

CE 0546

- 36615 GERMOCID BASIC - 750 ml

For disinfection and fast cleaning of every kind of medical surface materials which are not sensitive to alcohol like arms, handles and different dentistry objects.

- **Disinfectant action:** the association between Chlorhexidine and Quaternary ammonium Salt and the high alcoholic content guarantee a large action spectrum towards:

- Bacteria gram<sup>+</sup> and gram<sup>-</sup>, fungi and virus HIV, HBC, HCV (HEPATITIS B and C) in **1 minute of contact**.

- Fungi, microbacteria and TBC in **5 minutes of contact**.

Strong detergent power and fast evaporation.

It is not de-activated by organic substances.

- **Bactericide, virucide and fungicide activity.**

Sold in box of 12 - only 2 bottles come with vaporizer.

- 36691 VAPORIZER



## ENVIRONMENT DISINFECTANT

- 36616 ENVIRONMENT DISINFECTANT - bottle of 1 litre
- 36617 ENVIRONMENT DISINFECTANT - tank of 3 litres

Concentrated liquid detergent-disinfectant for environments.

Dilute it in water to a ratio of 0.5% for the disinfection and the cleaning of surfaces, counter, tiles, floors, sanitary fixtures, also using floor-washing machines.

Suitable in large areas (hospitals, clinics, rest homes, gyms, swimming pools) for the disinfection and cleaning of surfaces.

- **Disinfectant action:** guarantees a wide protection against virus, fungi, bacteria Gram<sup>+</sup> and Gram<sup>-</sup>.

- **Detergent action:** contains non-ionic surface active agents to enhance the cleaning of surfaces.



### CHEMICAL COMPOSITION

100 g of product contain:	
Quaternary ammonium compound	10 g
Isotyzolinone magnesium chloride	0.2 g
Coformulants and deperated water	100 g

Appearance: pale yellow liquid

Smell: citrus flavour

Biodegradability: detergent according to rules CE n° 648/2004

Italian Health Ministry authorization N° 9658

# BRANSON ULTRASONIC CLEANERS

## Precision cleaning power

Ultrasonic cleaning is faster and safer than any other method. It's powerful enough to remove heavy oils and waxes, penetrating enough to deflux circuit boards, yet gentle enough to clean tiny precision assemblies. Ultrasonic sound waves moving through a cleaning solution create an effect called cavitation, the rapid formation and implosion of microscopic bubbles. Heat enhances the process. The deep-cleaning action of ultrasonics removes even the most stubborn dirt and contaminations.

## Branson: pioneer in ultrasonic cleaning

We have selected Branson because their cleaners incorporate years of experience in ultrasonic cleaning:

- easy to handle and safe to fill
- frequency higher than average for a deep cleaning
- less noise - longer lifetime.

All Branson cleaners are supplied with tank cover, and multi-language manual (GB, FR, IT, ES, DE, PT, SE, NL, RU). Recommended use with optional perforated tray.

## M Series: M (Mechanical timer) or MH (Mechanical timer with heater)

Includes 60-minute mechanical timer and continuous operation with heating capability (MH only).

## CPXH Series (Digital control with heater)

Are the most technologically advanced ultrasonic cleaners available. With programmable features, digital operation with power tracking capabilities to adjust for light or heavy loads, high/low power control and degassing. The CPXH is the most versatile system available.

CPX series is completely programmable, so engineers can choose temperature, start, and stop times for "set-it-and-forget-it" operation

Degassing periods of up to 99 minutes also allow for various sample prep applications.

Digital timer allows for continuous ultrasonic operation up to 99 minutes

Temperature can be set for either Fahrenheit or Celsius up to 69 °C/156.2 °F

Ultrasonic power tracking maintains steady, consistent activity in the bath when condition change



Feature	M Series Mechanical	MH Series Mechanical	CPXH Series Digital
Timer	60 minutes	60 minutes	60 minutes
Cover	•	•	•
Continuous mode	•	•	•
Sweep frequency	•	•	•
Heater	•	•	•
Dual power	•	•	•
Power tracking	•	•	•
Degas wave modulation	•	•	•
°C or °F temp selection	•	•	•
Auto ultrasonic activation	•	•	•
High-temp alarm	•	•	•
Front panel auto temp calibration	•	•	•
Operating parameters stored and saved	•	•	•

High/low power control provides safer cleaning of delicate components. 100% power for normal or 70% for delicate applications

	TECHNICAL SPECIFICATIONS			
	Branson 2800	Branson 3800	Branson 5800	Branson 8800
Tank size: mm	230x140x100	290x150x150	290x240x150	495x290x150
Overall size: mm	337x304x302	397x317x377	397x401x378	596x466x391
Tank capacity: litres (gal)	2.8 (0.75)	5.7 (1.5)	9.5 (2.5)	20.8 (5.5)
Drain and valve kit	No	Included	Included	Included
Weight: kg (lbs)	4.1 (9)	5.4 (12)	6.4 (14)	11.8 (26)
Frequency	40 KHz	40 KHz	40 KHz	40 KHz
Power supply	230-240 V	230-240 V	230-240 V	230-240 V

4 SIZES: 2.8, 5.7, 9.5, 20.8 LITRES.

3 MODELS: MECHANICAL, MECHANICAL + HEATER, DIGITAL + HEATER



ULTRASONIC CLEANERS	BRANSON 2800 2.8 litres	BRANSON 3800 5.7 litres	BRANSON 5800 9.5 litres	BRANSON 8800 20.8 litres
M Mechanical timer	35501	35510	35520	35531
MH Mechanical timer with heater	35502	35511	35521	35532
CPXH Digital timer with heater	35503	35512	35522	35533
ACCESSORIES	Branson 2800	Branson 3800	Branson 5800	Branson 8800
Tank cover, plastic* or stainless steel**	35507*	35517*	35527*	35537**
Perforated tray	35508	35518	35528	35538
Tray	35505	35515	35525	35535
Beaker positioning cover	35506 2x 250 ml	35516 3x 250 ml	-	-
Beaker positioning cover 600 ml	35509 2x 600ml	35519 2x 600ml	35529 4x 600ml	35539 6x 600ml
Glass beaker 250 ml	35540	35540	-	-
Glass beaker 600 ml	35541	35541	35541	35541



## FREE AND BASIC ULTRASONIC CLEANERS



35553

35550

ULTRASONIC CLEANERS	BASIC	FREE	BASIC	FREE
	3 l	3 l	9 l	9 l
Tank size mm	235x100x135		332x120x227	
Overall size mm	305x248x168	305x248x178	418x268x259	418x268x269
Weight kg	3.7	4	7.1	7.4
Ultrasonic power W	150	150	300	300

### ULTRASONIC CLEANERS

The ultrasonic tub is designed to wash instruments used in the medical, dental, cosmetic, veterinary fields. The ultrasound cleaning (cavitation) allows to thoroughly clean instruments difficult to clean manually.

#### Heating - FREE only

The device heats the detergent and stops automatically when the preset temperature is reached.

#### Degassing (degas) - FREE and BASIC

This process reduces the gas dissolved in the liquid, thus improving the efficiency of the subsequent washing.

#### Ultrasonic cleaning - FREE and BASIC

Washing phase through ultrasonic cavitation.

#### Sweep - FREE and BASIC

Ultrasonounds are modulated in frequency, thus reducing the negative effects of stationary waves, increasing the distribution of ultrasonic energy within the washing liquid.

#### Discharge - FREE only

Tub of Basic has to be manually emptied, tub of Free can be emptied by opening the appropriate valve.

All ultrasonic cleaners are supplied with basket and lid.

GIMA code	FREE AND BASIC ULTRASONIC CLEANERS
35550	Basic ultrasonic cleaner 3 l
35551	Free ultrasonic cleaner 3 l - with heating and discharge
35552	Basic ultrasonic cleaner 9 l
35553	Free ultrasonic cleaner 9 l - with heating and discharge

## ULTRASONIC CLEANER



### • 35549 GIMA 50 ULTRASONIC CLEANER 0.6 l

This ultra-compact cleaner is very easy to use, efficient and economic. Ideal to clean small objects. Electronic, non adjustable timer with plastic cover and basket. No heating. Internal size: 168x89x55 mm. Supersonic wave 46,000 cycles per second.

## GENERAL PURPOSE CLEANER

### • 35544 BRANSON GENERAL PURPOSE CLEANER - bottle 1 l concentrate

BRANSON PURPOSE is a cleaning solution developed for use with ultrasonic cleaners. Removes general soils, fingerprints, dust, light oils and greases.

Branson cleaning liquid has been specially developed to provide optimal transfer of acoustic energy.

Mainly used in: dentistry, medical and optical applications, laboratory, electronics, gold and silver works.



#### CHEMICAL SPECIFICATIONS

Concentration: 10-12%  
Biodegradability: yes  
Phosphate free  
Concentration PH: 13.5  
Rinsability: good

## GIMA QUICK: STERILIZATION IN 2 MINUTES

### • 35640 GIMA QUICK - hot bead sterilizer

### • 35642 GIMA QUICK PLUS with thermometer

GIMA QUICK hot bead sterilizer has been designed and developed specifically for medical use. Also recommended for dentistry, podology, veterinary, tattoo and beauty studios. It ensures a quick and effective sterilization.

It sterilizes files and mirrors in 2 minutes, surgical instruments in 2 minutes, curettes and forceps in 3 minutes.

Its constant temperature over 230°C ensures the total destruction of micro-organisms and spores in few seconds.

GIMA QUICK has epoxydic powders painted steel casing; the inside cylinder is completely isolated by fibres and glass, which prevents heat from being transmitted to the external casing.

It can work continuously for the whole day.

Supplied with a pack of glass beads (220 g).

Made in Italy.

### • 35645 PYREX BASIN

### • 35646 PACK OF GLASS BEADS



CE 0425

35640

35642

#### TECHNICAL SPECIFICATIONS

Outer structure in white painted steel	Weight: 2.8 kg
Size: 130x130x190 mm	Power consumption: 150 W
Copper plated basket: diameter 5.5 cm	Operating voltage: 220 V - 50 Hz.
depth 7.5 cm	Warranty: 12 months
	Made in Italy

## DIGITAL OR THERMOVENTILATED DRY HEAT STERILIZERS



35584

Outer case and front completely made of stainless steel, included the drummed door strongly insulated with non-conducting material

TITANOX dry heat sterilizers 20, 60, 120 litres. Inner structure and height adjustable inner shelves completely made of stainless steel. Door with lock and key.

**Thermovenilated unit:** to guarantee the uniformity of the temperature in the heating room and to allow the circulation of the air, the device is provided with a ventilation motor that results always in operation, both during the cycle of heating and during the pauses of cooling.

**Digital unit:** adjustable aeration tunnels, placed on the bottom of the right side and on the top of the left side for hot air adjustment and circulation, which is useful for a quick cooling of the device.

GIMA code Thermoventilated	GIMA code Digital	Capacity	Outside dimensions (mm)	Inside dimensions (mm)
35583	35586	20 l	570x345xh 400	405x255xh 210
35584	35587	60 l	705x450xh 475	535x320xh 345
35585	35588	120 l	835x565xh 555	670x420xh 415



35586

Outer case made of steel, hinged door completely made of stainless steel

Supplied with manual in: GB, FR, IT, (ES on request) and 2 height adjustable trays. Made in Italy.

### TECHNICAL SPECIFICATIONS

**Thermovenilated:**

- Timer 0-120 minutes that switches off the oven at the end of the planned time
- Probe thermometer from 0° to 200°
- Probe thermoregulator from 0° to 200°
- Safety thermostat
- Ventilator for forced ventilation
- Double check up light bulb

**Digital:**

- Electronic running C.P.S.
- Use modality: continuous (stand by) or timed
- Timer from 0 to 250 minutes
- Optimum heat distribution
- Automatic indication for possible problems of feeding (in case of mains tension lack, the program will start again from the beginning)



35586

Operating voltage: 230 V - 50/60 Hz (110 V on request with surcharge for 35583-5)

## TAU STERIL AUTOMATIC DRY HEAT STERILIZERS 1.6, 6, 18 LITRES



35600

35606

35606

0426

- 35600 TAU STERIL 1.6 - automatic hot air sterilizer
- 35606 TAU STERIL 6 - automatic hot air sterilizer
- 35619 TAU STERIL 18 - automatic hot air sterilizer

TAU sterilizers have been designed to satisfy all daily medical requirements in the field of sterilization.

Extremely robust, totally automatic, guarantee complete working safety.

**TAU 1.6 and 6** have double wall and inner insulation, outside is made of stove-enamelled sheet steel, inside of stainless steel 18/8 (double cover, sterilization chamber and removable perforated tray).

**TAU 18** comes complete with safety fuses, neon warning lights to control timer and thermostat, power cable, 3 itallumac treated shelves (375x200 mm), shelf extracting tongs.

Shining 18/8 stainless steel non corrosive, almost indestructible sterilization chamber which reflects the heat to reach rapidly desired temperature.



Front door, side and back in epoxy powder painted

35619

### TECHNICAL SPECIFICATIONS

	TAU 1.6	TAU 6	TAU 18
Inside dimensions (mm):	245x115xh 55	385x170xh 90	375x230xh 200
Outside dimensions (mm):	310x180xh 180	495x310xh 220	440x310xh 380
Weight:	5 kg	10.5 kg	14 kg
Operating voltage:	220 V	220 V	220 V
	110V available on request		
Power consumption:	250 W	400 W	600 W
Fuses:			3.15 A
Thermostat:	Automatic capillary bulb type with self registration from 90° to 200°		
Timer:	from 0 to 120 minutes		
Thermometer:	high precision with capillary bulb		
Made in Italy			

# HOT AIR STERILIZERS: GIMETTE 1.5, 7, 21, 28 AND 50 LITRES



GIMETTE 1,5

35601

- 35601 GIMETTE 1.5 - hot air sterilizer
- 35607 GIMETTE 7 - hot air sterilizer



Automatic Gimette are compact and high quality hot air sterilizers with the same reliability and efficiency as larger models. Outside structure is made of painted plate with anti-scratch epoxy powder. Stainless steel lid and sterilization chamber with approx. Capacity of 1.5 l and 7 l. Removable, perforated for air circulation, tray with pliers. All components certified by most important European brands, assembling in compliance with EN-61010. A second safety thermostat triggers in case temperature should exceed 220°C. Red LED indicates any anomaly in thermoregulation and consequent starting of safety thermostat.

- 35631 RESISTOR 250 W for 35601 - spare
- 35632 RESISTOR 400 W for 35607 - spare
- 35612 GASKET for 35607 - spare
- 35613 GASKET for 35601 - spare



GIMETTE 7

35607

### TECHNICAL SPECIFICATIONS

#### GIMETTE 1.5

Inside dimensions: 245x120x50 mm = vol. 1.5 dm<sup>3</sup>  
 Outside dimensions: 310x180x180 mm Weight: 4.3 kg  
 Power consumption: 250 Watt Fuse: 1 A

#### GIMETTE 7

Inside dimensions: 410x180x90 mm = vol. 7 dm<sup>3</sup>  
 Outside dimensions: 490x310x180 mm Weight: 8 kg  
 Power consumption: 400 Watt Fuses: 2 x 2.5 A

Thermometer: high precision with capillary bulb

Same specifications for both models:

Operating Voltage: 230 V - 50 Hz  
 Thermostat: automatic, adjustable 0-200 °C  
 Timer: manual from 0 to 120 minutes  
 2° Thermostat: bi-metallic certified  
 Green LED: timer, orange LED: heating, red LED: alarm  
 Made in Italy - Warranty 1 year  
 User/Service manual in IT, GB, FR



GIMETTE 21

35621

- 35621 GIMETTE 21 - hot air sterilizer
- 35628 GIMETTE 28 - hot air sterilizer
- 35629 GIMETTE 50 - hot air sterilizer



Fully automatic hot air sterilizer, with adjustable temperature from 0°C to 200°C, kills off even particularly resistant micro-organisms. Stainless steel structure is powder painted, except for the door, to assure maximum heat and shock resistance over time. Four perforated, anodized aluminium trays make hot air circulation easier. Capacity approximately 20 l, 28 l and 50 l. A second safety thermostat triggers in case temperature should exceed 230°C.

### SPARE ACCESSORIES

STERILIZER	TRAY	GASKET	RESISTOR 600 W
Gimette 21	35610	35614	35639
Gimette 28	35611	35615	35639
Gimette 50*	-	35617	35639

\*Needs 2 resistors



GIMETTE 28

35628

Red LED indicates any anomaly in thermoregulation and consequent starting of safety thermostat.

### TECHNICAL SPECIFICATIONS

	GIMETTE 21	GIMETTE 28	GIMETTE 50
Inside dimensions mm:	300x250x260	380x250x260	405x340x350
Approx. volume	20 dm <sup>3</sup>	28 dm <sup>3</sup>	50 dm <sup>3</sup>
Outside dimensions mm:	440x340x400	550x340x400	605x460x480
Weight:	13 kg	17 kg	24.5 kg
Power consumption:	600 Watt	500 Watt	1200 Watt

Same specifications for 3 models:

Operating Voltage: 230 V - 50 Hz  
 Fuses: 2 x 4 A (35621, 35628) 2 x 8 A (35629)  
 Timer: manual from 0 to 120 minutes  
 Thermostat: automatic  
 Thermometer: high precision with capillary bulb  
 2° Thermostat: bi-metallic certified  
 Green LED: timer, orange LED: heating, red LED: alarm  
 Made in Italy - Warranty 1 year  
 User/Service manual in IT, GB, FR

## PRESTIGE CLINICAL AUTOCLAVES: EXCELLENCE THROUGH DESIGN



35709



Only 335 mm

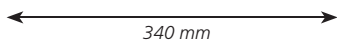

Manual in: GB, FR, IT, DE, ES, PT, NL, DK, NO, SE, GR

### PRESTIGE AUTOCLAVES - class N

Prestige is one of the world's largest selling and most cost effective automatic autoclave available, with an enviable reputation for reliability, durability, safety and quality.

- method recommended by healthcare professional worldwide including the World Health Organisation (WHO)
- each autoclave is computer tested and issued with a unique Performance Test Certificate
- at only 4.5 kg net weight, offers full device portability
- supplied with basket and multilingual user manual

Recommended for infection control not only in hospital and general medical and dental surgeries, but also in veterinary, chiropody, professional beauty, tattooists, acupuncture, laboratories and schools.

Comply with: IEC 61010 (product safety), BS3970 part 4 (pressure vessel only), BS 5500 (pressure vessel).

#### TECHNICAL SPECIFICATIONS

	35709	35712
Capacity:	9 l	12 l
Chamber internal dimensions (D/H)	210/236	210/328
Maximum instrument length (diagonal):	228 mm	290 mm
Maximum loading weight:	3 kg	4 kg
Width/height:	340/335	340/420

#### Same specifications for 2 models:

Sterilizing time: 11 minutes  
 Cycle time (nominal): 22 minutes  
 Operating pressure: 1.40 bar  
 Sterilizing temperature: 126 °C  
 Operating voltage: 230 V - 50-60 Hz - Power 1,250 Watt  
 Made in UK - Warranty: 1 year



35712

GIMA code	PRESTIGE MEDICAL AUTOCLAVES
35709	Prestige autoclave 9 litres
35712	Prestige autoclave 12 litres
35720	Silicone sealing gasket
35724	Depressurization valve - since 2011

## GIMA VERTICAL AUTOCLAVE H100 - 9 LITRES - CLASS N

• 35746 H100 GIMA AUTOCLAVE - 9 litres - 230 V

Safe and easy to use autoclave to sterilize surgical instruments and hand-pieces which can be sterilized up to 125°C, with a sterilization cycle of 15 minutes only. External frame of painted steel and stainless-steel 18/10 body without any welding. Equipped with three safety valves. Made in Italy.



### Safety systems

- safety lock to prevent opening of the door during the sterilization cycle; the door can only be opened when pressure inside the chamber is levelled to the ambient one
- safety valve for vapour exhaust in case of damage with inside overpressure > 2.5 bar. Safety valve TUV certified (PED IV)
- safety thermostat which occurs if the inner temperature of the chamber rises over 135°C
- safety valve kit to adjust pressure if it rises over 2.0 bar
- thermodynamic vacuum

Complies with 93/42/EEC Class IIb, IEC601, EMC

• 35747 SEALING GASKET for H100 with serial number: A, D, E, F, K, L. Please advise if different serial number.

#### STANDARD ACCESSORIES

- Stainless steel basket int: Ø 195xh 183 mm
- ext: Ø 210xh 210 mm with feet
- User manual in GB, IT, ES on request FR, DE
- Electric cable
- Distilled water bottle 1 l

#### TECHNICAL SPECIFICATIONS

External size: 250x385xh 310 mm  
 Size of the sterilizing chamber:  
 Ø 220 mm - h 235 mm  
 Removable basket: Ø 210 mm - h 210 mm  
 Sterilizing liquid: distilled water  
 Absorbed power: 1500 Watts  
 Operating voltage: 230 V - 50/60 Hz  
 Fuses: type 6.3 x 32 mm - 8A  
 Operating temperature: 125 °C  
 Sterilizing time: 15 minutes  
 Operational pressure:  
 1.3/1.6 bars (130/160 KPa)  
 Net weight: 13.3 kg  
 Warranty: 1 year



35746

Starting cycle knob

Safety bolt and valve indicating pressure

## GERMY GIMA PLUS: GERMICIDAL ULTRAVIOLET LAMPS



35751



AVAILABLE IN 3 SIZES

### GERMY GIMA PLUS: ULTRA VIOLET LAMPS

These instruments incorporate a germicidal ultra-violet lamp which rapidly destroys every micro-organism hit by its rays. Recommended to keep the instruments stored inside sterile. Instruments previously sterilized can be preserved for a long time and they are always ready for use (UV treatments do not generate heat).

An inside supporting grate keeps instruments raised from reflecting surface which enables both surfaces to be uniformly irradiated, improving the UV germicidal action.

Operator safety is guaranteed by a micro switch which extinguishes the lamp if door is opened.

Solid construction, painted steel outside and reflecting stainless steel inside.

Installation on table or wall.  
 Operating voltage: 230 V - 50/60 Hz - 1 A  
 Made in Italy.

- 35750 GERMYP GIMA PLUS 8 W - 38x20xh 17 cm
- 35751 GERMYP GIMA PLUS 15 W - 50x24xh 20 cm
- 35752 GERMYP GIMA PLUS 30 W - 96x24xh 20 cm
- 35754 SPARE NEON LAMP - 8 Watt
- 35755 SPARE NEON LAMP - 15 Watt
- 35756 SPARE NEON LAMP - 30 Watt

# HYDRA EVO ELECTRONIC 15 OR 18 L STEAM AUTOCLAVE - N

- 35658 HYDRA EVO AUTOCLAVE - 15 litres - 230 V
- 35659 HYDRA EVO PLUS AUTOCLAVE - 18 litres - 230 V

Automatic steam autoclaves for the sterilization of unwrapped instruments. Closure system with an operator safety pivot. Thermodynamic system for the ejecting of the "cool" air locks.

**Two sterilization cycles: 121°C and 134°C**

Automatic phases of pre-heating, sterilization cycle and drying.

**Pre-set, non-modifiable cycles**

All cycles are pre-set at the factory and guarantee perfect and safe sterilization of treated materials. There is no way the operator can manipulate or alter the cycles, and this safeguards against risks deriving from human error.

**Pre-set temperatures**

The temperatures set for our autoclave cycles are 134°C and 121°C. The 134°C cycles are normally used for the sterilization of solid and ferrous materials. 121°C cycles are normally used for sterilization of thermoplastic and delicate materials.

**Water tank**

Hydra EVO only has one water tank. This tank must be filled with distilled or demineralized water and acts as a container for collecting the used water which is then re-utilized for new cycles.

**Safety on the door**

Each door is equipped with 2 locks:

- a mechanical one which does not open when pressure is exerted
- a dynamic one, that operates thanks to a special form of door seal

**Safety devices installed**

- Certified safety valve
- PED on sterilization chambers
- Insulation of the chamber with certified ceramic material.



35658

93/42/EEC  
73/23/EEC  
93/336/EEC

Medical device  
Low tension  
Electromagnetic  
Compatibility



**Controls on the Autoclave**

- Control of the water that enters into the chamber
- Safety Thermostat
- Time Control

The sterilization chamber is completely stainless steel AISI 304 and it is heated by a band shaped heating element which grants uniformity of the heat. Supplied with four aluminium trays and one key for their extraction.

User manual available in English, French, Italian, Spanish.

- 35671 Sealing GASKET - spare
- 35669\* HEATING BAND DHY A035 for 35650, 35654
- 35670\* HEATING BAND DXB A835 for 35658, 35659

\*Need serial number of autoclave

Cycles	Materials	Sterilization time	Drying time	Max load	Working pressure
Not wrapped 121° C	•Fragile solids •Rubber solids •Glass •Turbines if indicated by producer	20 min.	5 min.	2.8 kg 700 g load in any tray	1.2±1.3 bars
Not wrapped 134° C	•Stainless metal solids •Turbines if indicated by producer	10 min.	5 min.	2.8 kg 700 g load in any tray	2.1±2.2 bars

**TECHNICAL SPECIFICATIONS**

Stainless steel chamber: Ø 24.5 x 32 cm Ø 24.5 x 40 cm (Plus)  
External size: 44 x 38 x 50 cm (W x H x D)  
Net weight: 35 kg  
2 sterilization cycles: 121°C and 134°C  
Operating Voltage: 230 V±10% - 50/60 Hz  
Power consumption: 1700W  
Class N  
Made in Italy - Warranty: 1 year



# NUBYRA 6 LITRES STEAM AUTOCLAVE - CLASS N



35647

- 35647 NUBYRA AUTOCLAVE - 6 litres - 230 V

Electronic steam autoclave for the sterilization of unwrapped instruments. 2 fully automatic, microprocessor controlled, sterilization cycles: at 134°C or 121°C with short or long automatic drying.

LCD display with visualization of temperature and pressure for total control of sterilization cycle. Easy closure system with double safety sensor. Air pockets automatic ejection system: thermodynamic system for the ejection of "cold" air pockets. Anodized aluminium chamber, 2 electronic temperature sensors (1 inside chamber and 1 outside) and electronic transducer for better control of pressure.

Supplied with 3 aluminium trays.

- 35648 GASKET - spare

93/42/EEC  
2014/35/UE  
2014/30/UE  
EN 13060

Medical device  
Compatibility



Cycles	Materials	Sterilization time	Drying time	Max load	Working pressure
Not wrapped 121° C	•Fragile solids •Rubber solids	18 min.	5 min. short dry or 15 min long dry	1 kg 500 g load in any tray	1.1±1.2 bars
Not wrapped 134° C	•Fragile solids •Rubber solids	6 min.	5 min. short dry or 15 min long dry	1 kg 500 g load in any tray	2.1±2.2 bars

**TECHNICAL SPECIFICATIONS**

Anodized aluminium chamber: Ø 17x26.5 cm - 6.1l  
External size: 44.5x48x35 cm  
Trays size: 1 large 15x24x2 cm  
2 small 11x24x2 cm  
Maximum load: 1 kg (short dry)  
0.5 kg (long dry)

2 sterilization cycles: 121°C and 134°C  
Operating voltage: 230V - 50/60 Hz  
Max absorbed power: 1,350 Watt  
Net weight: 27 kg Class N  
Made in Italy - Warranty: 1 year  
User manual: GB, IT (FR, ES on request).

# EUROPA B EVO: CLASS B AUTOCLAVE 15 AND 24 l

EN13060

Tray holder with 4 aluminium trays



Supplied with 1 closed tray holder, 4 aluminium trays, 1 double-use key for tray extraction and door adjustment, water loading and unloading hoses, chamber cleaning sponge and integrated osmosis system (35657 only)



35653



Constant control and monitoring of the entire autoclave functional system.



Sterilization Cycles 121°C-134°C suitable for both enveloped and free materials. All cycles are for type-B loads.

As regards to safety in health practice, sterilisation is the first aspect to consider. Autoclaves offer physical and legal safety. This is why autoclaves must be chosen according to rational logics and based on professional and not only cost-related evaluations.

With the new EN 13060 standard, the choice of the right autoclave is now easier for professionals: they must choose a certified, adequate model, based on the type of materials to sterilise. A B-type loads autoclave allows to sterilize hollow materials such as handpieces and turbines and porous materials (overall, gauze...).

### P.I.D. System (Proportional Integral Derivate)

It represents the top of closed loop controls. P.I.D. ensures a constant control and monitoring of the whole operating system of the autoclave, acting automatically in case of anomalies or incorrect technical and electronic parameters.

### Internal tanks

All the autoclaves are equipped with an internal tank for pure water and another for used water. Each tank is equipped with probes to detect the minimum and maximum water levels.

### Preset temperatures

The preset temperatures used in our autoclaves cycles are 134°C and 121°C. 134°C cycles are normally used for sterilization of solid and ferrous materials. 121°C cycles are normally used for sterilization of thermoplastic and delicate materials.

### Ease of use

Sterilization cycle is selected by pushing one button and activated by pushing another. First button allows to scroll and view data about all sterilization cycles on the display and select the cycle that suits your materials best, second button automatically starts the whole sterilization cycle. It is impossible to make mistake or choose an inadequate sterilization cycle. In case of any error or warning a series of messages and LEDs will inform you about the problem.

### Fully automatic cycles

All cycles are fully automatic, with all steps managed by the leading-edge computer board with a powerful microprocessor. Each step (vacuum, preheating, exposure time, drying) is automatically monitored, assisted and handled. There is no need for human intervention in cycle management.

**Cycles without operator intervention and with autoshtutdown** In sterilization cycles an automatic function will trigger an anti-

35657



Autoclave equipped with integrated printer

condensation process and auto-shutdown if the operator is not by the machine when the cycle ends.

### Test cycles

Our autoclaves are equipped with test cycles for periodic control by means of physical and functional tests.

Helix test, to assess vacuum capacity in hollow bodies.

Bowie & Dick test to evaluate vacuum capability in hollow bodies. Vacuum test to evaluate vacuum retaining capability.

### Constantly monitored cycles

A device constantly controls and monitors the sterilization cycles. Any anomaly or uncommon feature is quickly detected and immediately blocked if it jeopardises the sterilization cycles. The operator is warned of the anomaly by a message.

### All cycles ensure sterilization of B-type loads

All the sterilization cycles feature the fractional vacuum system as well as the controls of parameters that ensure sterilization of B-type loads. Therefore, even if the type of cycle chosen is incorrect the sterilization carried out on the material will be equally adequate.

### Integrated Osmosis system (35657 only)

Inverse osmosis is a safe water treatment system that eliminates even the tiniest polluting particle, to guarantee bacteriological purity. It works through an osmotic membrane which is able to filter water down the molecular levels.

GIMA code	CLASS B AUTOCLAVES
35653	Europa B Evo Autoclave - 15 l
35657	Europa B Evo Autoclave - 24 l with integrated osmosis system
SPARES	
35672	Bacterial filter for Europa B conical threading 1/8 Compatible also with W&H, Cominox, Mocom, Mediline, Euronda
33250	Thermal paper 57mm x 25m (pack of 5 rolls)

Cycles	Working pressure min-max	Minimum time of the total cycle* - minutes	
		Europa B EVO	Europa B EVO 24
121° C Wrapped	1.04 - 1.30	60 min. (25+18+17)	56 min. (25+18+13)
121° C Unwrapped	1.04 - 1.30	49 min. (25+18+6)	55 min. (25+18+12)
134° C Flash	2.02 - 2.38	31 min. (25+4+2)	33 min. (25+4+4)
134° C Wrapped	2.02 - 2.38	47 min. (25+5+17)	43 min. (25+5+13)
134° C Unwrapped	2.02 - 2.38	36 min. (25+5+6)	42 min. (25+5+12)
134° C Prion	2.02 - 2.38	62 min. (25+20+17)	58 min. (25+20+13)

\*The total time includes: vacuum, pre-heating time, cycle and drying phase.

The times are to be intended for a fully loaded autoclave.

All sterilization cycles have 3 stages of vacuum.

Vacuum and pre-heating time can vary depending on the conditions of autoclave from 25 to 35 minutes

### TECHNICAL SPECIFICATIONS

	35653 Europa B - 15 l	35657 Europa B - 24 l
External size mm (WxHxD):	510x390x590	510x390x730
Chamber size mm (Øxdept):	245x320	245x500
Operating voltage	230V - 50/60 Hz	230V - 50/60 Hz
Max absorbed power	1,700 W	2,200 W
Weight kg:	54	58
Built in printer:	yes	yes
Manual closing:	yes	yes
Fitting for pura deioniser:	yes	yes
PID system	yes	yes

# ANDROMEDA VACUUM XP AUTOCLAVE WITH PRINTER 15-21 LITRES

Twin tanks for pure and used water: by using always pure water, the internal components are protected, with benefits in maintenance and service costs

Door opening block with electromagnet



Door gasket

Bacteriological filter

**CLASS S**



Stainless steel chamber, uniformly heated by a band heating element

Electronic printer

Digital control

93/42/EEC  
73/23/EEC  
93/336/EEC

Medical device  
Low tension  
Electromagnetic  
Compatibility

Andromeda Vacuum is supplied with printer built into the drive board. The printer document certifies the sterilization by indicating all the data related to the cycle.

ANDROMEDA VACUUM XP  
Release: 1.01  
Ciclo: N° 000835  
Serial: N° 000181  
Date: 08-05-99  
Time: 09:39  
Ciclo: 5  
121°C 1.2 Bar 34 min.  
VOLUME INCHIAMO  
UNWRAPPED

TIME	TEMPERATURE	PRESSURE
09:39	045	0.0
09:44	049	-0.8
09:53	122	1.2
09:54	121	1.2
09:55	121	1.2
09:56	121	1.2
09:57	121	1.2
09:58	121	1.2
09:59	121	1.2
10:00	121	1.2
10:01	121	1.2
10:02	121	1.2
10:03	121	1.2
10:04	121	1.2
10:05	121	1.2
10:06	121	1.2
10:07	121	1.2
10:08	121	1.2
10:09	121	1.2
10:10	121	1.2
10:11	118	0.5
10:12	106	0.0
10:13	102	-0.1
10:14	100	-0.1
10:15	099	-0.1
10:16	096	-0.3
10:17	095	-0.3
10:18	095	-0.3
10:19	094	-0.4
10:20	092	-0.4
10:21	090	-0.5
10:22	090	-0.1
10:23	089	-0.1
10:24	092	-0.1
10:25	092	-0.1
10:26	092	-0.1
10:27	092	-0.1

END CYCLE OK  
Operator

- 35651 ANDROMEDA VACUUM XP - 15 litres - 230 V
  - 35662 ANDROMEDA VACUUM XP - 21 litres - 230 V
- Pre-and post-vacuum:** Andromeda Vacuum is provided with powerful vacuum pump which, at the beginning of the cycle, ejects the airpockets from the sterilization chamber, and at the end of the sterilization phase ensures a very good drying.
- Rapid preheating:** A very new method of preheating, through a special band heating element, gives a high reduction of the preheating times.
- Guaranteed sterilization:** A sophisticated electronic device gives a constant monitoring of pressure, temperature and time. In case of anomalies there will be an electronic lock of the autoclave and the display will indicate the anomaly.

**TECHNICAL SPECIFICATIONS**

External size: 45x39x54 cm (35651), 45x39x66 cm (35662)  
Chamber dimension: Ø 24.5x32 cm depth (35651),  
Ø 24.5x43 cm depth (35662)

Weight: 50 kg  
Operating Voltage: 230 V - 50/60 Hz  
Power consumption: 2000 Watt  
Made in Italy Class S

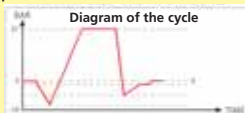

Andromeda Vacuum is provided with 5 cycles of sterilization: 121° C and 134° C for unwrapped and wrapped instruments, and a "Flash" cycle for the fast sterilizations.

Cycles	Temperature	Max load	Pressure	Total time*
Program 1 Unwrapped instruments	134° C	2.8 kg	2.2	33
Program 2 Wrapped instruments	134° C	2.8 kg	2.2	38
Program 3 Unwrapped instruments	121° C	2.8 kg	1.2	42
Program 4 Wrapped instruments	121° C	2.8 kg	1.2	46
Program 5 Flash	134° C	2.8 kg	2.2	16

\* pre-heating - vacuum - cycle - drying in vacuum

User manual available in English, French, Spanish, Italian, German

**"Night" cycle with anti-condensate device**

Andromeda Vacuum can work also without the operator presence as all functions are automatic. At the end of each cycle a special device eliminates the backwater of condensate, afterwards there is the automatic sign off, but with electronic storage.

**Safety of the operator:** Andromeda Vacuum has an electromagnetic block device on the door. The door opens only with atmospheric pressure into the chamber, and after having pressed the push button.

Completely computerized monitoring of all automatic functions, and auto-diagnosis of each component. The total automation of each phase of the cycle prevents any possible human error, also from inexperienced personnel

Timed start, with positioning in "Stand-by" at 80°C and automatic switch off after one hour not in use.

Automatic filling up of the water: a pump allows the filling up, and stops automatically when the maximum level is reached.



- 35671 SEALING GASKET - for Andromeda and Europa
- 35672 BACTERIAL FILTER - for Andromeda and Europa
- 35673 VAPOR LINE STERILIZATION INTEGRATOR - for Andromeda and Europa
- 35652 THERMAL PAPER 60 mm x 25 m

## DISTILLER: SYSTEM OF WATER DISTILLATION



Size Ø 20 cm x h 36 cm

35690

**35690 WATER DISTILLER**

The autoclaves must run with distilled or demineralised water to avoid problems on electrovalves and on internal mechanism and white traces of limestone on the sterilized tools and devices. Distiller produces 100% distilled water in a cheap and safe way. It produces 4 litres in about 7 hours. It is equipped with an automatic control thermostat with block system at the end of operation.

Supplied with 6 active coal filters, 1 detergent, 1 container for produced distilled water. Operating Voltage: 220 V - 50-60 Hz.

- 35691 COAL FILTERS FOR DISTILLER - box of 12
- 35692 DETERGENT FOR DISTILLER

## DIGITAL SEALING MACHINES WITH/WITHOUT DOT MATRIX PRINTER



35909, 35910

- 35909 D-400 SEALING MACHINE without printer
  - 35910 D-500 SEALING MACHINE with dot matrix printer
- Continuous sealing machines for medical pouches according to DIN rules 58953-7:2010 with or without dot matrix printer. They allow a 12 mm multi-line seal and features stand-by function and automatic infeed through photocell. D-500 is equipped with **built-in printer** to print different data on the bag (sterilization/expiry dates) during the sealing process in order to provide constant control on the sterility of your instruments, especially when the paper layer of the

sterilization bag is less tight, after 30 days, and consequently losing instruments sterility. Built in epoxy coated stainless steel. D-400 and D-500 are sophisticated units controlled by a microprocessor and equipped with a device to adjust temperature (displayed by LCD) and printing parameters. **The sealing pressure is automatically adjusted according to the material thickness.** It also guarantees 30 mm safety distance between seal and product, according to DIN rules. Easy to use and maintenance-free, they are the ideal solution for clinics and hospitals. Compatible for sealing with Tyvek rolls and envelopes. Made in Italy.



- 35912 INK-CARTRIDGE D-500/700 - spare part

TECHNICAL SPECIFICATIONS		
	35909	35910
Infeed speed	6 m/min	
Temperature control	by digital thermoregulator	
Sealing temperature	40°±200° C	40°±180° C
Temperature tolerance	±5°C	
Seal	Multiline	
Seal width	12 mm	
Adjustable free edge	0 ÷ 30	
Power supply	230 V-50 Hz-single phase	
Absorption	500 W	600 W
Dimensions	473x235xh 181 mm	
Net weight	11.5 kg	12 kg

## SEALING MACHINES WITH VALIDATION SYSTEM



35915, 35916

COMPLYING WITH  
ISO 11607 P.2,  
ISO/TS 16775

- 35915 D-600 ROTARY HEAT SEALER - without printer
  - 35916 D-700 ROTARY HEAT SEALER - with printer
- With validation system complying with ISO 11607 P.2 rule. GIMA 600 and GIMA 700 have been designed to continuously monitor, during the whole sealing phase, all critical process parameters: Temperature, Speed, Pressure. They guarantee sealing in full respect of EN 868-5 / ISO 11607 P.2 rules, provide real-time monitoring of working temperature, applied force

and running speed, time used during the sealing process. All sealing data can be recorded on an external carrier which can be linked to the sealer through a USB port placed on the unit. They are controlled by a microprocessor. Operator's interface is a clear 2 line display, integrated in an ergonomic keyboard placed at the upper side of the sealer in an extremely user friendly position. Simple use, high reliability, they are the ideal solution for hospitals and clinics. Compatible for use with Tyvek rolls and envelopes. Made in Italy.

- 35912 INK-CARTRIDGE D-500/700 - spare

TECHNICAL SPECIFICATIONS		
	35915	35916
Sealing width	12 mm	12.5 mm
Seal	multiline	
Sealing speed	6 m/min	8.5 m/min
Temperature adjustment/ tolerance	10-200°C ± 5 °C	
Alarms functioning out of tolerance	yes	yes
Automatic stand-by	yes	yes
4 key membrane keyboards	yes	yes
LCD display 2 lines	6 characters	8 characters
Multilanguage menu	yes	yes
USB port	yes	yes
Data storage on pendrive	yes	yes
Power	230 V / 50 Hz - single-phase (on request 110 V, 60 Hz)	
Max electrical input:	500 W	500 W
Dimensions - Weight:	473x235x181 mm - 12.5 kg	

## STEAM AND DRY HEAT ADHESIVE TAPE INDICATORS



35846

35842

MEET EN ISO 11140-1 : 2014  
FOR PART APPLICABLE TO TYPE 1 E1

### STEAM AND DRY HEAT TAPE INDICATORS

Gima range of tapes is specially formulated for packing purposes as well as to show visibly that the pack has undergone a sterilization cycle. The backing of the different tapes is made of strong, semicreped, impregnated paper which gives excellent conformability during the application. Sterile tapes unwind easily and can be torn by hand without difficulty.

Special adhesives formulated to withstand high temperature and humidity ensure excellent bond to paper, plastic, non-wovens, board, metal, glass and linen.

Each tape is individually packed with due date. Made in Italy.

TAPE INDICATOR - 50 m	Width 19 mm	Width 25 mm	Minimum order
Dry Heat Tape - hot air sterilizer	35842	-	12 rolls
Steam Tape - autoclave	35846	35847	12 rolls

## D-351 SEALING MACHINE: ELECTRO-MAGNETE OPERATION



35900



Electromagnet closing

• **35900 D-351 IMPULSE SEALING MACHINE**  
Compact impulse medical sealers, conform to DIN 58953 P.7 rules, specially designed to be used in medical, dental, oculistic surgeries and test laboratories.  
**Main features:** sealing and cutting length 35 cm - Safety check with alarm. Main board with temperature control to avoid overheating of the sealing wire - Sealing bars closed by electromagnet. Complete with foil-roll dispenser and built-in cutting device.

**Easy:** by the pressure of only one finger, without using levers, the bars close automatically. The electro-magnet guarantees a steady sealing pressure for the whole set period. The sealing bar opens automatically at the end of the cycle, requiring no action by the operator.

**Quick:** the electro-magnetic system allows a substantial saving of the packing time. Quick foil feeding.

**Safe:** the machine does not start the sealing cycle if there is an object with a thickness over 3 mm between the bars.

The electronic temperature control through a NTC probe provides a perfect temperature accuracy from seal to seal. The electronic alarm function avoids any overheating.

Made in Italy.

• **35902 TEFLON - spare**

• **35903 RESISTOR - spare**

### TECHNICAL SPECIFICATIONS

Sealed materials: paper/polyethylene/polyester  
Sealing length: 350 mm  
Sealing width: 8 mm as per DIN 58953-7:2010  
Electronically controlled sealing time: 0.5 sec.  
Cutting length: 350 mm Foil-roll dispenser 350 mm  
Power: 230V- 50/60 Hz single - phase  
Max absorption: 700W, only during the sealing time  
Dimensions: 44x17.5x31 cm Weight: 18 kg  
Built in accordance with CE Norms

## GD-301 EVO SEALING MACHINE FOR CONTINUOUS HEAT SEALING



35929

### TECHNICAL SPECIFICATIONS

Flat sealing 12 mm Sealing length 300 mm  
Thermo controlled continuous heat sealing  
Built-in cutting device  
Fixed sealing temperature and sealing time  
Manual actuation Power 230 V / 50-60 Hz, single phase  
Electrical input: 900 W Protection degree IP 20  
Sealer dimensions 452x248x146 mm  
Roll-holder dimensions 458x412x242 mm

• **35928 GD-301 EVO SEALING MACHINE - machine only**

• **35929 GD-301 EVO SEALING MACHINE - complete**

Manual heat sealer for medical pouches and reels according to DIN 58953-7:2008. New models with **3 ceramic heater elements** for a faster and more accurate sealing and **improved infeed and outfeed guide** to keep film flat (infeed) and prevent the film moving upward inside machine.

Available in 2 versions: compact without accessories (35928) or with sealer roll holder, cutter and plane (35929)

User friendly, reliable and extremely compact, ideal in dentistry, medical and veterinary laboratories.

Sealing bar 300 mm manually actuated by a lever.

Thermo controlled continuous heat sealing, to save consumables. Compact vertical design to reduce space at the minimum. Integrated, removable roll-holder, can stand alone apart from the sealer.

Usable only with polypropylene film coupled to medical grade paper and/or plastic envelopes suitable for steam sterilization.

• **35933 CERAMIC HEATING ELEMENTS - spare**

• **35935 BLADES - kit of 5 - spare**



35928

## TESTS FOR AUTOCLAVE

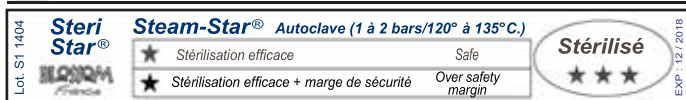

Notice "Stérilisé" and three stars drawing change colours

from white to dark brown to show safe sterilization of 121°C - 15 minutes or 134°C - 3.5 minutes

from white to black to show sterilization over safety margin 121°C - 20 minutes or 134°C - 5 minutes

• **35849 "STEAM STAR" INDICATOR - autoclave - box of 1,000**

Indicator for sterilization by autoclave with pressure 1 to 2 bar 120°C/135°C. No special stocking requirements. Safety and reliability. Made in Japan.

## BOWIE & DICK TEST READY FOR USE



35853

Colour change from dark to green



Test sheet before sterilization

Test sheet after sterilization Failed test

Test sheet after sterilization Correct test

• **35853 UPSTAR - "BOWIE & DICK" - test - 14x14x0.8 cm**

The Bowie & Dick ready to use test pack is designed to control the proper functioning of steam autoclave and to test its ability to sterilize porous devices (compresses, fields, gowns, woven or non-woven,...)

- High sensitivity: detects any default.

- Easy interpretation.

- Stability of color change.

- Waterproof aluminium packaging

EN 867 - Class B  
ISO 11140 - Class 2

## ROLLS FOR AUTOCLAVE, STEAM AND ETO

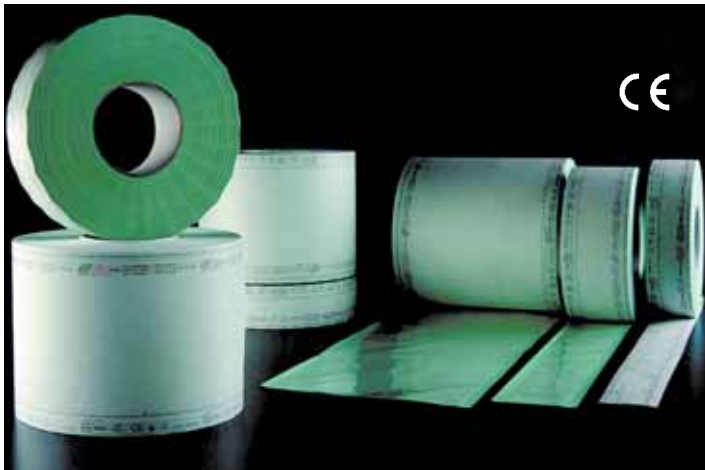

OTHER SIZES AVAILABLE

**FLAT ROLLS** for sterilization by steam or ethylene oxide gas  
Flat rolls consist of transparent, polyester-polypropylene film coupled to medical grade paper which permit steam and gas penetration during sterilization. Steam and gas indicators provide clear colour changes when exposed to sterilization process. **Each roll is 200 m long.**

FLAT ROLLS FOR AUTOCLAVE, STEAM AND ETO				
GIMA code		External m x mm	Internal m x mm	Minimum order
35810	Flat rolls	200x50	200x36	8 rolls
35811	Flat rolls	200x75	200x53	8 rolls
35812	Flat rolls	200x100	200x78	4 rolls
35813	Flat rolls	200x150	200x128	4 rolls
35814	Flat rolls	200x200	200x178	2 rolls
35817	Flat rolls	200x250	200x228	2 rolls
35815	Flat rolls	200x300	200x278	2 rolls
35816	Flat rolls	200x400	200x378	1 roll

GUSSET ROLLS FOR AUTOCLAVE, STEAM AND ETO				
GIMA code		External m x mm x mm	Internal m x mm x mm	Minimum order
35871	Gusset rolls	100x100x25	100x78x25	4 rolls
35872	Gusset rolls	100x150x25	100x128x25	4 rolls
35873	Gusset rolls	100x200x30	100x178x30	2 rolls
35874	Gusset rolls	100x250x32.5	100x228x32.5	2 rolls
35875	Gusset rolls	100x300x40	100x278x40	1 rolls
35876	Gusset rolls	100x400x40	100x378x40	1 rolls

**GUSSET ROLLS** for sterilization by steam or ETO  
Made with coated film PET 12/PP 40 green and 60 g medical white paper.  
For sterilization of voluminous objects.  
**Each roll is 100 m long.**

## FLAT AND SELF-SEAL POUCHES FOR AUTOCLAVE



**SELF-SEAL POUCHES**  
for sterilization by autoclave, steam or ethylene oxide gas

Self-seal pouches consist of light green, polyester-polypropylene transparent film coupled to medical grade paper which permit steam and gas penetration during sterilization.  
**Steam and gas indicators change colour when exposed to sterilization.**

1. Reinforced corners to prevent dust from collecting near to the opening, reducing the risk of contamination during opening.
2. The laminated transparent film complies with the German standard EN 10/204. The medical paper conforms to the following standards: DIN 58953 (German), Pharmacopoeia 589 (French), pr EN 868-3 (European) and BS 6256 (English).
3. The chevrons allow rapid and correct opening.

4. These consist of one layer of laminated transparent film (special type polyester and copolymer polypropylene) and white damp-resistant medical Kraft paper, specially designed to assure a high anti-bacterial protection.

5. The heat-sealed lines (Multiline) are highly resistant and spaced equally; the external welding runs along the entire length of the pouch.

Reels and pouches are certified and are manufactured according to international standards DIN 58953 BS 6871, EN 868-5, CN 13485

OTHER SIZES AVAILABLE  
minimum 10,000 pouches

FLAT POUCHES FOR AUTOCLAVE, STEAM AND ETO				
GIMA code		External mm	Internal mm	Minimum order
35880	Flat pouches	100x300	78x285	1,000
35881	Flat pouches	150x200	128x185	1,000
35882	Flat pouches	150x250	128x235	1,000
35883	Flat pouches	150x300	128x285	1,000
35884	Flat pouches	150x400	128x385	1,000
35885	Flat pouches	200x300	178x285	1,000
35886	Flat pouches	200x350	178x335	500
35887	Flat pouches	200x400	178x385	500
35888	Flat pouches	250x400	228x385	500
35889	Flat pouches	250x500	228x485	500
35890	Flat pouches	300x400	278x385	500
35891	Flat pouches	400x600	378x585	500
35895	Special size pouches			10,000

SELF-SEAL POUCHES FOR AUTOCLAVE, STEAM AND ETO				
GIMA code		External mm	Internal mm	Minimum order
35860	Self-seal pouches	90x165	68x150	1,800
35861	Self-seal pouches	90x230	68x215	1,800
35862	Self-seal pouches	140x250	118x235	1,200
35863	Self-seal pouches	190x330	168x315	1,200
35864	Self-seal pouches	190x400	168x385	1,200
35866	Self-seal pouches	300x450	278x435	400

## BOWIE DICK TEST PACK

Package and manual in: GB, IT, ES, FR, PT, GR, DE.



Dimensions: 123x123x16 mm

- **35950 BOWIE DICK TEST PACK - box of 20 pcs**  
Used for daily monitoring of pre-vacuum steam sterilizer. Based upon the Bowie Dick test result the steam sterilizer is released for usage during the day. The Bowie Dick test detect failures like air leaks, insufficient vacuum, inadequate steam penetration.
  - fulfill requirements of EN 285 and ISO 17665
  - conform to ISO 11140 - 4 Type 2 / EN 867 - 4 class B (EU standard 7 kilo)
  - independently tested to show performance similar to original pack
  - clear blue - violet colour change
  - easy to interpret and document
  - non-Toxic / lead free

## TYPE 5 MOVING FRONT

Conform to ISO 11140 - type 5



User manual: GB, IT, FR, ES,

Non-toxic / lead free

- **35952 TYPE 5 MOVING FRONT INTEGRATOR box of 1,000 pcs**  
Moving front integrators 134 °C - 3.5 min are giving you the best interpretation possible in case of any failure in your steam sterilization cycle. If temperature is not reached or holding time was too short the dark colour will not reach the accept area.
  - shelf life: 5 years after production
  - packed in white aluminium re.closable bags
  - very easy interpretation of result
  - complete indicator area sealed of by foil

## TYPE 4 STEAM INDICATOR



- **35954 TYPE 4 MULTI-VARIABLE STEAM STRIPS - box of 250 dual strips**  
Type 4 multi-variable steam indicator strips are designed to be used in steam sterilizers operating at 134 °C - 3.5 min. The indicator strips will provide assurance of steam penetration into the packs. The water based, non-toxic chemical indicator in compliance with ISO 11140-1 will show a clear colour change from blue to black after successful steam sterilization. Test indicator strips are cost effective and can be divided into two separate pieces for economical use.

## TYPE 6 STEAM INDICATOR



- **35955 TYPE 6 EMULATING STEAM STRIPS - box of 250 strips**  
Type 6 emulating steam indicator strips are designed to be used in steam sterilizers operating at 121 °C - 15 min and 134 °C - 3.5 min. The cycle verification indicators can be used in every pack and will provide assurance of steam penetration into the packs and presence of all critical parameters of steam sterilization cycle. The water based, non-toxic chemical indicator in compliance with ISO 11140-1 will show a clear and accurate colour change from blue to lilac after successful steam sterilization.

## BOWIE DICK HELIX TEST

Includes: cotton bag, helix device (tube 1.5 m), 100 tests and user manual GB, FR, IT, ES.



- **35951 BOWIE DICK HELIX TEST PACK - box of 100 pcs**  
Helix devices and their indicators have proven that they detect failures during each cycle much earlier than other chemical indicators / integrators. The EN 285: 2009 are specifying the Helix test (Hollow A) to be used as Bowie Dick Test as well as Batch Monitoring when hospitals are sterilizing hollow loads, Next to that this Bowie Dick Helix Test is an obligatory test for class B Bench Top Steam sterilizers.
  - conform to ISO 11140 - 1 Type 2 - EN 867 part 5 class B
  - clear transition of color into pink
  - easy to interpret and document
  - non-Toxic / Lead Free
  - PCD guaranteed for 500 Cycles (134°C - 3,5 min)

## TYPE 5 STEAM INDICATOR

Conform to ISO 11140 - type 5

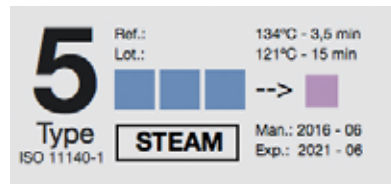

Package and manual in: GB, IT, FR, ES, PT, GR, DE

Non-toxic / lead free

- **35953 TYPE 5 STEAM INTEGRATOR - box of 500 pcs**  
Integrators can be used in addition to the batch control Helix which allow to release load. It allow to re-affirm sterilization condition inside trays or containers. SV: 134 °C - 3.5 min / 121 °C - 15 min
  - shelf life: 5 years after production
  - packed in an easy dispensing carton
  - clear colour transition from blue into pink of lacquer covered indicator

## TYPE 5 EO INDICATOR



- **35956 ETHYLENE OXIDE STRIPS - box of 250 dual strips**  
Type 5 Ethylene Oxide (EO) indicator strips are designed to be used at E.O. sterilizers in compliance with ISO 11135. The indicator strips can be used in every pack and will provide assurance of E.O. gas penetration into the packs. The water based, non-toxic chemical indicator in compliance with ISO 11140-1 will show a clear colour change from white to yellow after successful sterilization. Test indicator strips are cost effective and can be divided into two separate pieces for economical use.

## SEAL CHECKER

Dimension: 175x75



Suitable for all rotary heat sealers

- **35957 SEAL CHECKER - box of 250 pcs**  
The ISO-11607 standard is specifying a routine, daily check of your heat sealers. The seal checker is a way to perform the test required and to document which sealer, which day, which person did perform the test and to easily show results of your heat sealer capacity of properly heat seal your pouch. When place inside a pouch and seal, the sealed area will be darker and can be easily read whether the seal is consistent, regular and completely without any gaps.

## PILL MANAGERS



**PILL PULVERIZERS**  
See page 81.

## VET PRODUCTS

- **CLOGS**  
See page 24-25
- **TOURNIQUETS**  
See page 56
- **SCALPELS and BLADES**  
See page 41
- THERMOMETERS**  
See page 75-78
- **VET BAGS**  
See page 57-60
- **TROLLEYS**  
See page 113-123
- **BANDAGES, GAUZES, PLASTERS**  
See page 336-342
- **BARRYCIDAL 30 PLUS DISINFECTANT**  
See page 351

## BIOPSY PUNCHES

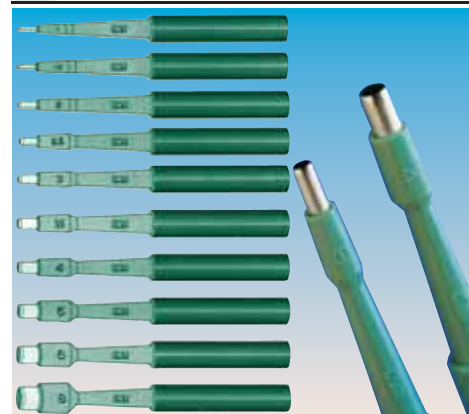

**BIOPSY PUNCHES**  
**DERMAL CURETTES**  
See page 42.

## SURGICAL CLIPPER



**SURGICAL CLIPPER**  
See page 42.

## SUTURES



**SUTURES AND SKIN STAPLER DEVICE**  
See page 39-40.

## SUCTION UNITS



**SUCTION UNITS**  
See page 161-164.

## ELECTROSURGERY



**ELECTROSURGICAL UNITS**  
See page 181-186.

## ELECTROSURGERY

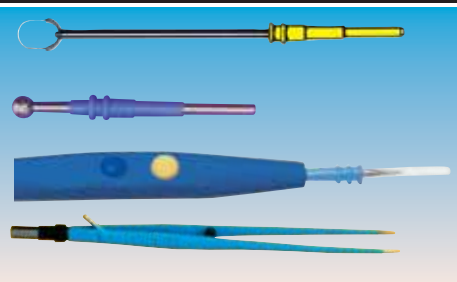

**ELECTROSURGERY ACCESSORIES**  
See page 187-192.

## HEADLIGHTS



**HEADLIGHTS**  
See page 195-198.

## EXAMINATION LIGHTS



**HALOGEN AND LED EXAMINATION LIGHTS**  
See page 199-205.

## 3M LITTMANN® STETHO



**3M LITTMANN® CLASSIC II**  
**3M LITTMANN® CARDIOLOGY**  
See page 235-238.

## SURGEON BRUSHES



**SCRUB KIT**  
**CHLOREXIDINA SCRUB KIT**  
**IDO-POVIDONE SCRUB KIT**  
See page 350.

## DIGITAL PET SCALES FOR LARGE AND SMALL ANIMALS

UP TO  
300 KG

80211



Both scales are supplied with handle

- 80210 DIGITAL VET SCALE - metal platform
  - 80211 DIGITAL VET SCALE - stainless steel platform
- High reliable and professional full electronic scale. Robust platform with a separate LCD digital display. Overload and low battery function. Switchable kg/lb/st. Made in Europe.

• 80216 AC POWER

### TECHNICAL SPECIFICATIONS

Capacity/Sensitivity: 300 kg / 100 g Minimum measurable: 2 kg  
Platform size: 600x800 mm Power: 9 V alkaline battery



Manual in DE, GB, FR, ES, IT, GR, CZ.

Taring functions switchable to kg/lb

- 27266 SOEHNLE 8320 FOLDABLE SCALE
- 27271 CARRYING BAG

Foldable scale with magnetic lock for easy transport.

### TECHNICAL SPECIFICATIONS

Capacity: 15 kg Sensitivity: 10 g  
Dimensions: 395x315x105 mm (closed) - 740x315x53 mm (open)  
Alkaline battery 2x1.5V AAA - not included  
Weight: 1.9 kg Warranty: 2 years Made in Germany



- 27258 DIGITAL PET SCALE - medium
  - 27259 DIGITAL PET SCALE - large
- Precise full electronic multifunctional scale, designed for measuring your pet's weight available in two sizes. Quality product with very competitive price. Minimal measuring weight: 2 kg. Made in Europe.

Tray 530x290 mm

Lb/kg/st switchable by user

LCD display 25 mm



Overload and low battery indication

Tare and automatic hold functions

- 27261 DIGITAL SMALL PET SCALE

### TECHNICAL SPECIFICATIONS

Capacity/Sensitivity: 20 kg / 10 g (27261) - 100 kg / 100 g (27258-27259)  
Minimum measurable weight: 20 g (27261), 2 kg (27258-27259)  
Dimensions: 355x635 mm (27258) - 620x830 mm (27259)  
Lithium battery: included Automatic switch-off

## DIAGNOSTIC AND OPERATIVE VETERINARY TABLES



Pack size: 121x15x90 cm  
Size: 120x58xh 85 cm  
Weight: 23 kg  
Load: 60 kg

- 80300 VETERINARY EXAMINATION TABLE
- Veterinary operating table with enamelled tubular steel frame, with AISI 304 15/10 stainless steel top with hole and a liquid tray holder underneath. Lateral hook to immobilize animals. Made in Italy.



Size: 118x56xh 85/102  
Weight: 48 kg  
Max load: 90 kg

- 80301 VETERINARY OPERATION TABLE
- Veterinary operating table with electric lift (82/102 cm), baked enamelled steel tubular frame and AISI 304 stainless steel top (120x56 cm) with hole and a liquid bucket holder underneath. Manual Trendelenburg 15° and Antitrendelenburg up to 15°. Lateral hook to immobilize animals. Made in Italy.

## S/S INSTRUMENTS

80001

80000

- 80000 Durante forceps - 15 cm
- 80001 Terza palpebra forceps - 11 cm
- 80002 Long Hartmann - 14.5 cm
- 80005 Mouth opener - 7 cm
- 80006 Mouth opener - 11 cm
- 80007 Mouth opener - 15 cm
- 80010 Rodent mouth opener - 6 cm
- 80011 Rodent mouth opener - 8.5 cm

80007

80002

80010

## URINE STRIPS

- 24100 VETERINARY URINE STRIPS - 11 parameters - bottle of 100 strips
- For examination of glucose, ascorbic acid, ketones, protein, ph-value, blood, nitrite, leukocytes, specific gravity, bilirubin, urobilinogen. Each box includes a manual for interpretation of results in each of the following animal: horse, pig, cattle, sheep, goat, dog, cat, bunny and guinea pig. Made in Germany by Analyticon.



Performs highest quality standard. Made in Germany

## VETERINARY ECG - 1 OR 3 CHANNEL

- 33305 VE-100 - 1 channel ECG
- 33306 VE-300 - 3 channel ECG
- 33336 ECG-Viewer software (GB, IT, FR, ES, RU, PT, PL, TU) for 33306

- complete digital design
- LCD display waveforms, parameter configuration
- high resolution thermal printer
- built in rechargeable Li-Ion battery for 6.5 hours use (AC/DC supply)
- complete digital filter, avoid baseline drift, AC, EMG interfere
- baseline automatically adjustable, optimizes printing position
- selectable auto/manual operation

### Features of VE-300 only

- 12 leads simultaneous acquisition
- automatic ECG parameter measurement and analysis
- support USB ink-jet printer for 12 leads printing
- 120 patient data storage and transfer by USB flash disk, Ethernet or series port
- review and management of ECG data on Window PC with software (optional 33336)



Internal software: GB, IT (33305/6), DE, FR, ES (33305 only)

- 32963 THERMAL PAPER ROLL 50mm x 25m for 33305
- 32964 THERMAL PAPER ROLL 80mm x 25m for 33306
- 33318 RE-CHARGEABLE LITHIUM BATTERY 2200 mAh
- 33319 5-LEAD VETERINARY ECG CABLE - spare

### STANDARD ACCESSORIES

- 5-lead veterinary ECG cable (Ø 4 mm, banana connector, IEC)
- Veterinary clip electrodes (set of 5, match Ø 3-4 mm ECG cable)
- 1 Paper roll
- Rechargeable lithium battery (2,200 mAh)
- Manual: GB, IT - on request FR, ES, DE

33306

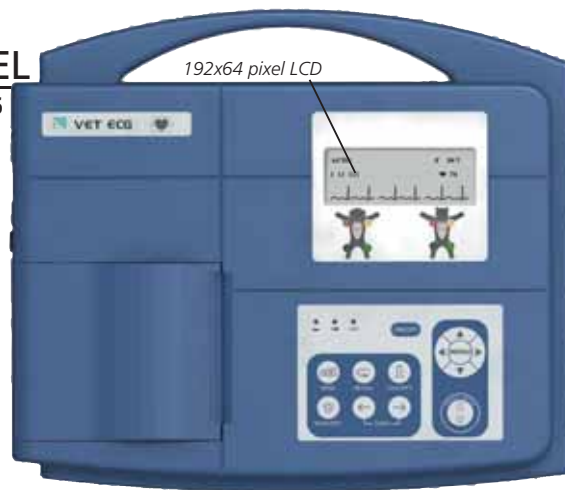

192x64 pixel LCD

### TECHNICAL SPECIFICATIONS

	33305	33306
Lead	standard 12 lead	12 leads simultaneously
Acquisition mode	One lead	12 leads simultaneously
Frequency response	0.05 Hz ~ 150 Hz	
Sensitivity	2.5, 5, 10, 20 (mm/mV)	
Input impedance	≥ 50 MΩ (10 Hz)	
Filter	EMG Filter 35 Hz (-3dB) AC/DFT Filter 50/60Hz (-20dB)	EMG Filter 25/35/45Hz / OFF DFT Filter 0.05/0.15/0.25/ 0.32/0.5/0.67 Hz Low pass Filter 150/100/75 Hz AC Filter on/off
Recording mode	Auto/Manual	Auto/Manual/Rhythm/OFF/USBPRT
Safety standard		IEC I/CF
Power supply	AC: 100-115 V, 220-240 V, 50/60 Hz	Built-in rechargeable Li-ion battery: voltage 14.8 V More than 6.5 hrs, continuously operation under battery supply
Thermal paper	50 mm x30 m	80 mm x20 m
Paper speed	25/50 mm/s (± 3%)	5/6.25/10/12.5/25/50 mm/s (± 3%)
Size	300x260x75 mm	
Weight	2.3 kg (with battery)	2.5 kg (with battery)
Display	192x64 pixel LCD	192x64 pixel LCD
External input/output	Input: ≥100 kΩ; Sensitivity: 10 mm/V ± 5%	output: ≤100 kΩ; Sensitivity: 1 mm/V ± 5%
Communication interface	RS232	Ethernet, RS232, USB

## BM3 AND BM5 PORTABLE MULTIPARAMETER VET MONITORS



33779

3-lead ECG clip

SpO<sub>2</sub> sensor

- 33719 BM3 VET MONITOR - 7" TFT display
  - 33779 BM5 VET MONITOR - 10.4" TFT display
- Versatile, portable, lightweight, BM monitors are designed to be used in veterinary environment. Compact design and handle make it easy to move. Colour monitor displays all vital signs in different colours for easy recognition. A built in printer offers hard copy documentation of all measured values. Alarms and settings are easily adjustable. See all specifications and accessories at page 290, 293.
- 33772 RECTAL TEMPERATURE SENSOR - 2.75 m cable
  - 33741 EXACON RECTAL TEMPERATURE SENSOR - 2.75 m cable

ECG+SpO<sub>2</sub>+NIBP  
+RESP+TEMPERATURE  
+2IBP (only 33779)

## VETERINARY DOPPLER

- 80600 GIMA VET DOPPLER - FIXED 8 MHz probe
- New doppler for detecting blood flow in small peripheral vessels with its unique 8 MHz probe ideal for veterinary practitioners for routine blood pressure measurement on pets. Flow signals are easily located using the lightweight narrow beam transducer while internal signal processing minimizes noise artefacts.

### TECHNICAL SPECIFICATIONS

<b>Ultrasound</b>	<b>Power supply</b>
Frequency: 8 MHz continuous wave	Battery 9V Alkaline (not included)
Transducer: 2 crystal narrow beam	Expected battery life: >9 hours
Output power: <15 mW/cm <sup>2</sup> SATA	<b>Output</b>
Audio Response: 300 Hz - 4 kHz	Headset: Audio output for optional headset (not included)
<b>Unit Controls</b>	<b>Material:</b> ABS / Noryl
Keys: 1 key (for unit on/off)	<b>Size:</b> 150x75 mm
Controls: rotary volume	<b>Weight:</b> 299 g (with transducer)
Indicators: yellow battery low LED	<b>Classification:</b> Class I Type B - IEC 60601-1

TOP QUALITY:  
MADE IN UK  
3 YEARS  
WARRANTY

80600



# CHISON ECO1 AND ECO3EXP. VET DIGITAL ULTRASOUND SYSTEMS



Adjustable monitor with 30° rotation



**ECO3EXP. VET**  
With PW (pulse doppler)

**ECO1 VET**

**CHISON**  
Value Beyond Imaging

	STANDARD PACKAGE		
	ECO1	ECO3EXP.	ECO5
12" high resolution LED monitor - B&W	•	•	•
12" high resolution LED monitor - colour	•	•	•
8G memory card	•	•	•
Hot Key	•	•	•
PC printer connection	•	•	•
3 USB port	•	•	•
1 ethernet port	•	•	•
1 video out port, 1 VGA out port	•	•	•
1 footswitch port	•	•	•
Full screen display	•	•	•
2 hours rechargeable lithium-ion battery	optional	•	•
Power adaptor	•	•	•
Standard software package	•	•	•
Easy View image archive system	•	•	•
THI	•	•	•
PW (doppler function to detect blood flow speed)	•	•	•

TECHNICAL SPECIFICATIONS						
Dimension and weight:	33.5x15.5xh 35 cm (13.2"x6.1"xh 13.8"); 6 kg					
Display:	12" LED, high resolution 1,024x768					
Power:	AC 100-240 V - 50/60 Hz rechargeable lithium-ion battery (ECO1 option, ECO3EXP. standard)					

LANGUAGE - switchable by user							
	GB	IT	FR	ES	DE	CZ	TR
Software	•	•	•	•	•	•	•
User manual	•	•	*				*

\*On request

- 33994 CHISON ECO1 VET with 1 probe connector without probe
- 33995 CHISON ECO3EXP. VET with 2 probe connectors without probe

- ultra-compact and ultra-light weight, easy to carry
- latest LED screen technology, super bright images allow to easily view scan even outdoor.
- ergonomic monitor design, 30 degree rotation, adjustable.
- ultra-long battery life up to 2 hours, for outdoor scanning
- one-key to enlarge image to full screen, easy to view from distance
- streamlined workflow, easy to operate, 6-one-key to finish the cycle of diagnosis.

**Display modes and imaging processing**

B, B/B, 4B, M, B/M, PW (ECO3EXP. only) multi-frequency imaging  
**Imaging processing**

- compound Imaging
- l-image intelligent image optimization
- THI (Tissue Harmonic Imaging)
- SRA (Speckle Reduction Algorithm)
- full digital beam-former
- full screen display
- trapezoidal
- automatic PW trace (ECO3EXP. only)
- Chroma
- AIO (Automatic Image Optimization)

**User interface**

- fold-up control panel and alphanumeric keyboard
- back-lit keyboard for good visibility in dark room
- interactive back-lighting
- indicator lights identify activated keys
- 8 TGC slides for easy adjustment
- short cut knob for quick adjustment (hot key user- defined)
- neat and clear keyboard layout, doctor can remember easily
- user defined preset

**Streamlined workflow, one key to:**

- select desired application with automatic preset
- optimize the image automatically (AIO)
- save still image and CINE loop
- print to PC printer\* (laser or inkjet) or video printer
- Make report
- Measure

\*See list of compatible printers on our website

**EASYVIEW™ Archive system**

- image archive on hard disk and USB mobile storage
- 3 USB ports
- multiple image formats: BMP, JPG, DCM, CIN, AVI
- cine review: auto, manual (auto review segment can be set) for 2D, M, PW (ECO3EXP. only) images
- cine memory capacity (256 frames/10s)

# CHISON ECO5 VET COLOUR DOPPLER DIGITAL ULTRASOUND SYSTEM



**ECO5 VET**

**34008**



**CHISON**  
Value Beyond Imaging

- 34008 CHISON ECO5 VET Colour Doppler 12" high resolution colour LED monitor, 8G high speed memory, 3 USB ports, 2 probe connectors, EASYVIEW™ archive system, without probe

- Imaging processing:**
- MCI (Multiple Compound Imaging)
  - i-image intelligent image optimization
  - THI (Tissue Harmonic Imaging)
  - SRA (Speckle Reduction Algorithm)
  - full digital beam-former
  - trapezoidal
  - automatic PW trace
  - Chroma
  - full screen display model
  - AIO (Automatic Image Optimization)

**Other specifications as ECO3EXP.**

**TECHNICAL SPECIFICATIONS**

Dimension and weight: 33.5x15.5xh 35 cm (13.2"x6.1"xh 13.8"); 6.5kg  
Display: 12" LED, high-resolution colour 1,024x768  
Power: AC 100-240 V, 50-60 Hz Rechargeable lithium-ion battery

# PROBES AND ACCESSORIES FOR CHISON ECO SERIES

PROBES ECO1 - 3 - 5			FREQUENCY(MHz)		Main application				
GIMA code	CHISON code	Scanning method	Main freq.	Probe band width	CANINE	FELINE	OVINE	EQUINE	BOVINE
33998	C3-A	Convex	3.5	2.5 - 5.0					
33999	L7M-A	Linear*	7.5	5.3 - 10.0	•	•	•	•	•
33871	L7S-A	Linear**	9.0	5.3 - 11.0	•	•	•	•	•
34000	L7V-A	Trans-rectal	7.5	5.3 - 10.0			•		
33997	MC6-A	Micro-convex	6.0	4.5 - 8.0	•	•			
33874	MC3-A	Micro-convex	3.0	2.5 - 5.0	•	•	•	•	•

\*With 40 mm footprint, general linear probe

\*\*With 30 mm footprint for superficial tissue exams with higher resolution

GIMA code	ECO SERIES ACCESSORIES
33869	Rechargeable lithium-ion battery BT-2500 (2.5 hours)
33867	ECO trolley TR-9000
33868	Carrying case
33866	Needle guided brackets - specify for which probe (available for 33998-9, 33874 only)
PRINTERS	
33968	SONY UP-X898 MD B&W printer (for ECO1 and ECO3EXP.)
33993	SONY UP25MD colour printer(for ECO5)



## HANDHELD VET PULSE OXIMETER



### • 34343 OXY 100 VET PULSE OXIMETER

OXY 100 Handheld Pulse Oximeter can measure oxygen saturation (SpO<sub>2</sub>) and Pulse Rate (PR) by placing the sensor on a certain part of the animal, such as tongue, ear, leg or tail. It also provides plethysmogram, bar-graph and Perfusion Index display.

- lightweight, small and easy to handle
- data storage with trend review
- two options for measurement on: thin tissue: such as tongue, ear, thick tissue: such as leg, tail.
- up to 384 hours of data memory (with 1/2/4/8 sec. recording interval)
- audible & visual alert for over-limits (limits are adjustable). Tested for cats and dogs. Not suitable for big or very small animals. See technical specifications page 297

Oximeter is supplied with universal "Y" type SpO<sub>2</sub> probe and three types of adapters: big clip, small clip and rubber wrapper. Each of these adapters allows a different measuring respectively on tongue, ear, leg or tail.

- 34346 UNIVERSAL "Y" type SpO<sub>2</sub> probe - spare includes 3 probe adapters (big clip, small clip, rubber wrapper).

## VET ELECTRONIC SPHYGMOMANOMETER AND SpO<sub>2</sub>



### • 80550 VET ELECTRONIC SPHYGMOMANOMETER

Electronic sphygmomanometer with fully automatic measurement of animals blood pressure and large, high definition colour LCD display.

- data storage for up to 100 groups of data with date and time
- automatic one-touch operation
- alarm function with possibility to set alarm limits
- dual scales: kPa and mmHg
- selection of five cuff sizes: small, small/medium, medium, large, X-large
- automatic power off

Supplied with medium cuff (10-19 cm) and multilanguage manual (GB, FR, IT, ES, PT)

30557

#### TECHNICAL SPECIFICATIONS SPO<sub>2</sub>

SpO<sub>2</sub> range: 0-100% (resolution 1%)  
 SpO<sub>2</sub> accuracy: 70%-100%: ± 2%  
 PR range: 30bpm-250bpm, (resolution 1bpm)  
 PR accuracy: ± 2bpm or ± 2% (select larger)

GIMA code	ACCESSORIES
80556	Power adaptor
80557	SpO <sub>2</sub> probe - optional
80558	Extension cable for 80557

GIMA code	CUFFS	Size	Suitable for
80551	Small	6-11 cm	Cats, baby dogs,...
80552	Small/medium	10-19 cm	Small dogs, fox, sheep...
80553	Medium	18-26 cm	Baby horses, baby pigs, big dogs, deers
80554	Large	22-32 cm	Horses, pigs, puma, baby bears, lions
80555	X-Large	33-47 cm	Bears, lions, tigers

#### TECHNICAL SPECIFICATIONS SPHYGMO

Measurement method: oscillometric  
 Measurement range: 0-38.67 kPa (0-290 mmHg)  
 Resolution: 1 mmHg  
 Accuracy: static pressure: ±0.4 kPa (±3 mmHg)  
 Inflation - Deflation: automatic inflation - automatic multistep deflation  
 Display: 2.8" colour LCD screen  
 Power: four "AA" batteries or optional power adapter  
 Safety: class II device type BF applied part  
 Dimension - Weight: 130x110x80 mm - 300 g

## VET STETHOSCOPE DIGITAL THERMOMETERS

### • 32545 REGALITE VET - black

Top quality single head stethoscope. Patented multi-frequency "ring-o-raised™" diaphragm system. Chromed plated chestpiece with "SUPERFLEX" inner spring binaural and 1 piece moulded PVC, latex free, tubing 90 cm long. Supplied in deluxe box, with spare soft eartips and one spare diaphragm.

90 CM LONG Y TUBE



32545

### • 25588 VET RECTAL THERMOMETER

25588

Designed to be ergonomically correct for animals. Setting for pets, pigs, cattle and other animals.

- 80450 VET DIGITAL THERMOMETER - flexible tip LCD size 15x7 mm



• 80455 THERMOFOCUS® ANIMAL NON CONTACT THERMOMETER  
 Infrared non contact thermometer allows to take pet's body temperature at distance from its eye. MQCS function allows manual calibration in case veterinary is moving to different environments. Thermofocus® animal is suitable for all animals and is multipurpose (can take temperature of liquid, food, ...). Made in Italy.

#### TECHNICAL SPECIFICATIONS

	25588	80450	80455
Measurement range:	32-44°C	32-42.9°C	32-43.5°C
Accuracy:	± 0.1°C (35-39°C)	± 0.1°C	± 0.2°C (36-39°C)
Battery life is approx.:	5,000 readouts		10,000 readouts
Dimension:	190x110x35 mm	138x21x10 mm	165x40x22 mm
Battery:	2x1.5V AAA	1.5V LR41	4x1.5 V AAA
Measurement time:		60 sec.	instantaneous

80455



Sold in blister

# MD SCOPE VET VIDEO OTOSCOPE



## MD SCOPE VET VIDEO OTOSCOPE

**Instant View**  
A clear and sharp image can be acquired and displayed instantly on a built-in screen.  
Just press a single button and wait for 3 seconds.

**Real Time Interaction**  
The medical image can be captured and displayed simultaneously on TV monitor or downloaded to Mac/PC system.

**Electronic medical record**  
A medical image is automatically generated to support most of the stand-alone health information system.  
Probes and accessories at page 208.

**TECHNICAL SPECIFICATIONS**  
2.4" colour LCD display  
Video out port  
Size/weight: 8x20 cm (2.5"x8") - 218 g  
Battery lifespan: 4 hours



- **32164 VET MD SCOPE PACK 32175**
- 3 cameras**
- 3 camera probes 75/150/300 mm
- image dongle
- cable set
- 2 AA alkaline batteries
- **32175 CRADLE**



# HEINE VET OTO AND OPHTHALMO



- **80500 BETA OTOSCOPE SET 2.5 V - G-112.10.118**  
Set complete with slit illumination head, 1 set long closed metal specula (57x4,65x6,90x7 mm), 1 spare bulb, hard case.
- **80501 BETA 200 VET F.O. XHL OTO-OPHTHALMO SET 2.5 V - G-151.10.118**  
Set complete with:
  - Beta 200 ophthalm, Beta 200 vet otoscope
  - 3 reusable Sanalons vet specula 61x Ø 4/6/9 mm
  - 1 spare bulb for each instrument
  - zipper case
- **31772 HEINE 077 OTOSCOPE BULB 2.5 V - spare**
- **31781 HEINE 069 OPHTHALMOSCOPE BULB 2.5 V - spare**

**F.O. XHL XENON HALOGEN TECHNOLOGY**



# VET OTOSCOPES, OPHTHALMO AND DIAGNOSTIC SETS



Open otoscope head is supplied with codes 31422, 31424, 31425



• **31442 PARKER VETERINARY OTOSCOPE**  
Includes: kit of 3 reusable plastic cannulas (31447)

• **31424 XENON HALOGEN DIAGNOSTIC SET**  
Includes: xenon halogen open otoscope head+handle, xenon-halogen ophthalmoscope head, kit of 5 reusable plastic cannulas (31451), metal tongue depressor holder illuminator, nasal specula  
**Rechargeable battery handle 2.5V**  
All sets have 2.5V handle for use with 2xC batteries or rechargeable batteries (34479)

• **31422 XENON HALOGEN OTOSCOPE SET**  
Includes: xenon-halogen open otoscope head+handle, kit of 5 reusable plastic cannulas (31451), kit of 3 reusable plastic cannulas (31447)

• **31425 XENON HALOGEN DIAGNOSTIC SET**  
Includes: xenon-halogen open otoscope head+handle, xenon-halogen ophthalmoscope head, kit of 3 reusable metal cannulas + 2 metal specula (31453)



GIMA code	VETERINARY SETS AND ACCESSORIES
<b>31451</b>	Kit of 5 reusable plastic cannulas (Ø 2.5, 3.5, 4.5, 5.5, 9 mm)
<b>31447</b>	Kit of 3 reusable plastic cannulas (Ø 4, 5, 7 mm)
<b>31453</b>	Kit of 3 reusable metal cannulas (Ø 4, 5, 6 mm) + 2 slotted metal specula (Ø 7.5, 9.4 mm)
<b>31454</b>	Nasal specula
<b>31478</b>	Xenon halogen otoscope bulb 2.5 V
<b>31479</b>	Xenon halogen ophthalmoscope bulb 2.5 V
<b>31449</b>	Standard otoscope bulb vacuum 2.5 V for 31442
<b>31542</b>	Charging station
<b>34479</b>	Rechargeable NimH battery 2.5 V / 3000 mAh
<b>31429</b>	Swivel lens 2X for Vet oto sets 31422, 31424, 31425

## HEAD AND BRAIN



• **40010 HEAD DISSECTION - life size**  
Size: 18x25x23 cm - 140 g - 4 parts - 1X

Life size

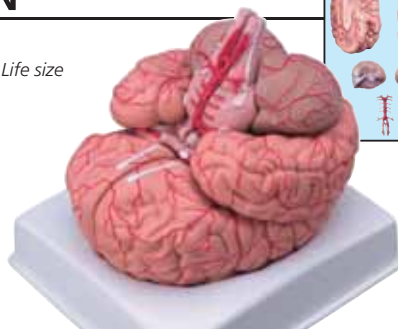

Can be divided into 9 parts showing the temporal and occipital lobes, the frontal and parietal lobes, the cerebellum, the brain stem and basilar artery

• **40020 BRAIN WITH ARTERIES**  
Size: 16x18x16 cm - 1 kg - 9 parts - 1X

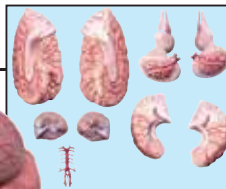

Life size brain with distinct colour for: frontal lobe, parietal lobe, occipital lobe, temporal lobe, motor cortex, somatosensory cortex, limbic cortex, cerebellum, brain stem

• **40021 REGIONAL BRAIN**  
Size: 20x17x15 cm - 1.3 kg - 2 parts

## SENSE ORGANS: EYE AND EAR

These models show the external, middle and inner ear. The eardrum with malleus, incus and stapes are removable. Also cochlea and labyrinth with vestibular and cochlear nerves and 2 bones sections (40042 only) that define the middle and inner ear are removable.



40041-40042

GIMA code	EAR SIZES	Kg	Parts	Mag
40041	33x23x21 cm	1	3	3X
40042	33x23x21 cm	2	5	3X

Cornea, iris, lens and vitreous body can be removed.

40030  
Assembled

40030  
Disassembled



40031  
40033

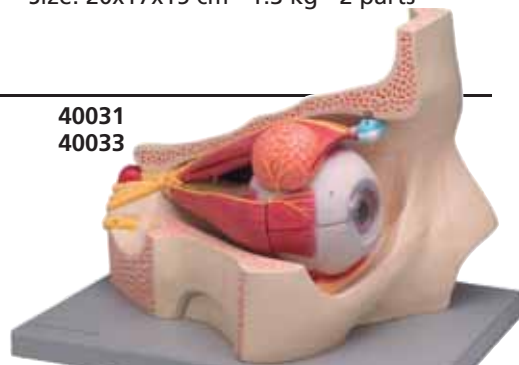

Models show the eye ball with optic nerves and muscles in its natural position in the bony orbit

GIMA code	EYE WITH ORBIT SIZES	Kg	Parts	Mag
40030	15x17x27 cm	0.9	6	6X
40031	42x30x31 cm	3.2	4	5X
40033	42x30x31 cm	3.4	11	5X

## RESPIRATORY SYSTEM: NASAL CAVITY, LARYNX



3x life size, the model shows a medial section of the nasal cavity. The nasal septum and part of the olfactory epithelium are removable to show deep internal structures.

• **40056 NASAL CAVITY**  
Size: 15x20x30 cm - 1 kg - 3 parts - 3X  
Mounted on base with stand.



A life size reproduction of the complete human respiratory system. It is composed of 7 parts showing the larynx (dissected along the sagittal plane), the lungs (dissected along the frontal plane) and a 2-part heart.

• **40050 RESPIRATORY SYSTEM**  
Size: 26x40x12 cm - 1.3 kg - 7 parts life size

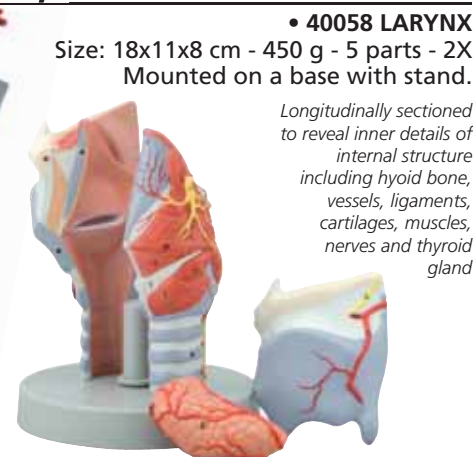

• **40058 LARYNX**  
Size: 18x11x8 cm - 450 g - 5 parts - 2X  
Mounted on a base with stand.

Longitudinally sectioned to reveal inner details of internal structure including hyoid bone, vessels, ligaments, cartilages, muscles, nerves and thyroid gland

## DIGESTIVE SYSTEMS: LIVER, PANCREAS, STOMACH

This model, 15x life size, shows the liver and gallbladder in open section with the complex network of vessels and bile ducts, displayed in different colours to clarity and ease of examination.

40080

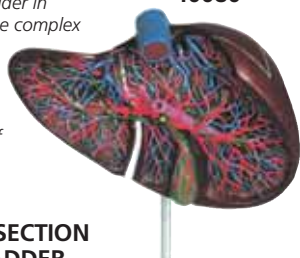

• **40080 LIVER SECTION WITH GALLBLADDER**  
Size: 28x27x14 cm - 880 g - 1 part - 1.5X  
Mounted on a base with stand.

Accurate representation of the pancreas, spleen and duodenum. The pancreas is open to show the entire pancreatic duct. The duodenum is partially dissected to expose its internal structure.

40086

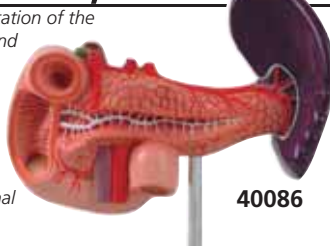

• **40086 PANCREAS, DUODENUM AND SPLEEN**  
Size: 16x15x23 cm - 350 g - 1 part - 1X  
Mounted on a base with stand.

Can be opened to show the internal structure of the stomach, including the mucosa, the pylorus, and a section of the gastric wall. Superficial dissection exposes the longitudinal, circular and oblique muscle layers, with nerves and vascular structures

40088

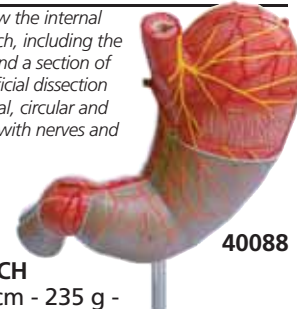

• **40088 STOMACH**  
Size: 16x14.5x5 cm - 235 g - 2 parts - 1.5X  
Mounted on a base with stand.

# HEART AND CIRCULATORY SYSTEM

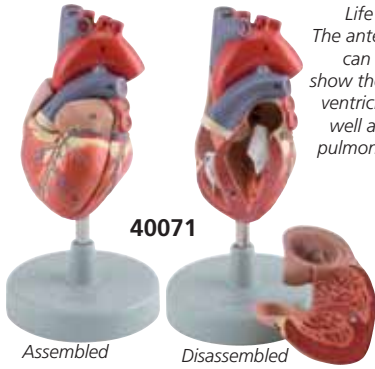

Assembled Disassembled

Enlarged 2000 times, this model shows the various types of blood cells, including red blood cells, white blood cells (lymphocytes, monocytes, neutrophils, eosinophils and basophils) and blood platelets.

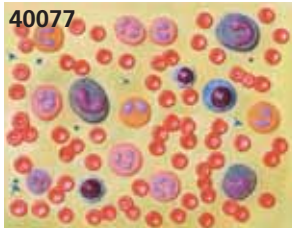

40077

Life size in 2 parts. The anterior heart wall can be removed to show the left and right ventricles and atria as well as the tricuspid, pulmonary, mitral and aortic valves.

Show internal structures including the cardiac valves and the comparative morphology of the right and left ventricles. The right atrium is also removable.



40072

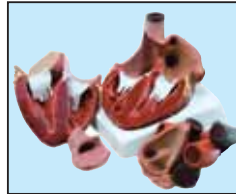

A general view of the human circulation. It includes the heart (2 parts), lungs, liver, spleen, kidneys and relevant connections with the pulmonary and systematic circulatory pathways.



40075

GIMA code	HEART AND CIRCULATORY SYSTEM	Size cm	Weight kg	Parts	Magnif.
40071	HEART - mounted on base	11x7x10	0.23	2	1X
40072	GIANT HEART - mounted on base	24x25x28	3.5	4	3X
40077	BLOOD CELLS - mounted on board	58x38x7	1.0	1	2000X
40075	CIRCULATORY SYSTEM - mounted on board	90x32x11	2.3	2	0.5X

# URINARY SYSTEM: MALE BLADDER, KIDNEY

## • 40090 MALE URINARY BLADDER WITH PROSTATE

Size: 27x20x15 cm - 1,2 kg - 2 parts - 3X

This model, enlarged 3 times, shows the male urinary bladder with the prostate gland surrounding the urethra. The model is dissected medially to expose both internal and external structures of the bladder and prostate, including the ureteric and urethral orifices, ductus deferens, seminal gland, ejaculatory duct.



40090

## • 40094 KIDNEY WITH ADRENAL GLAND+RENAL CORPUSCLE

Size: 40x15x8 cm - 1,2 kg - 1 part - 3X

This model shows a frontal section of the human kidney enlarged 3 times. The kidney is shown with the renal capsule. Additional structures include: the cortex, medulla, pyramids with papillae, partially dissected renal pelvis, renal calices, ureter, blood vessels, suprarenal gland with cortex and medulla. A schematic representation of the renal corpuscle with the system of collecting tubules is included.

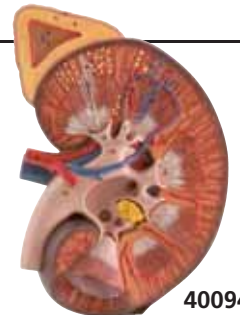

40094

# PELVIS - FEMALE AND MALE

40100

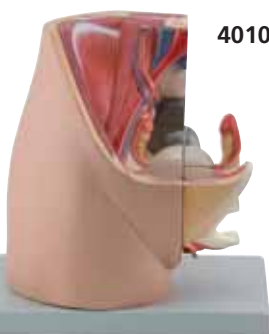

This life size model, composed of 3 parts, shows an open dissection through the median sagittal section of the pelvis. Internal structures of the female urogenital system are portrayed in great detail. Removable parts include half of the female reproductive system with the uterus opened to reveal medial and transverse sectional views.

40105

This life size model, composed of 4 parts, presents an open view through a median sagittal section of the pelvis. Internal structures of the male urogenital system are represented in fine detail. The removable parts include a half penis divided into medial and transverse sections, and half of the male reproductive system with an open dissection of a testis showing details of the internal structure.

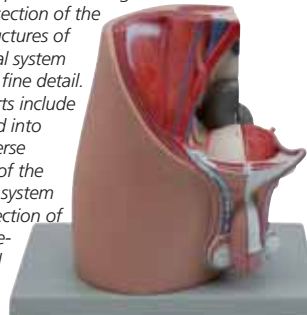

GIMA code	PELVIS size cm	Sex	Kg	Parts	Mag
40100	30x20x27	fem	1.7	3	1X
40105	30x20x27	male	1.7	4	1X

# PREGNANCY PELVIS

This life size model depicts the female human pelvis in median section with a fetus in the 40th week of pregnancy. The fetus is in the normal position prior to birth, showing the anatomical relationship between various structures of the maternal pelvis and the fetus. Fetus is detachable for closer examination.

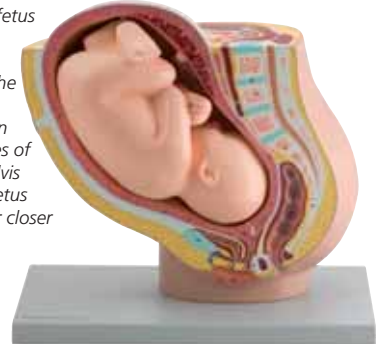

## • 40110 PREGNANCY PELVIS WITH MATURE FETUS

Size: 40x26x34 cm - 3.3 kg - 2 part - 1X

# SKIN

## • 40061 SKIN MODEL - 30X Size: 20x15x15.5 cm - 1.2 kg Mounted on base

All the skin layers can be easily identified and the main structures such as hair follicle, sensitive corpuscles, sebaceous and sweat glands, are numbered and referred on the accompanying k-card

40061

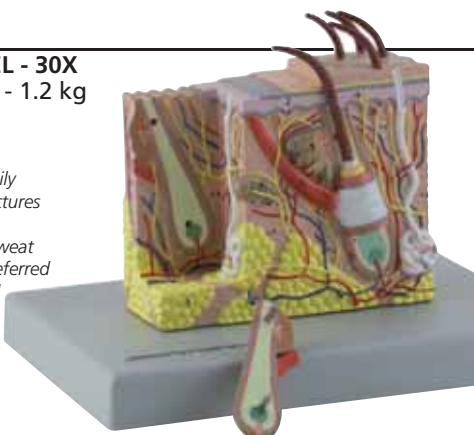

## • 40060 SKIN MODEL - 70X Size: 25x18x28 cm - 1.5 kg 2 parts - 70X Mounted on base

Anatomical structures are shown in details including the hair follicles, sebaceous glands, sweat glands, erector muscles, Pacinian corpuscles, nerves and blood vessels. The different layers of the skin are clearly defined. A portion of a hair shaft can be removed to show internal details.

40060

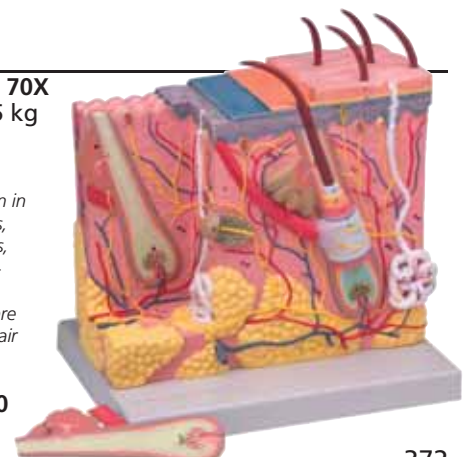

# HUMAN TORSOS WITH CD AND MUSCULAR FIGURES

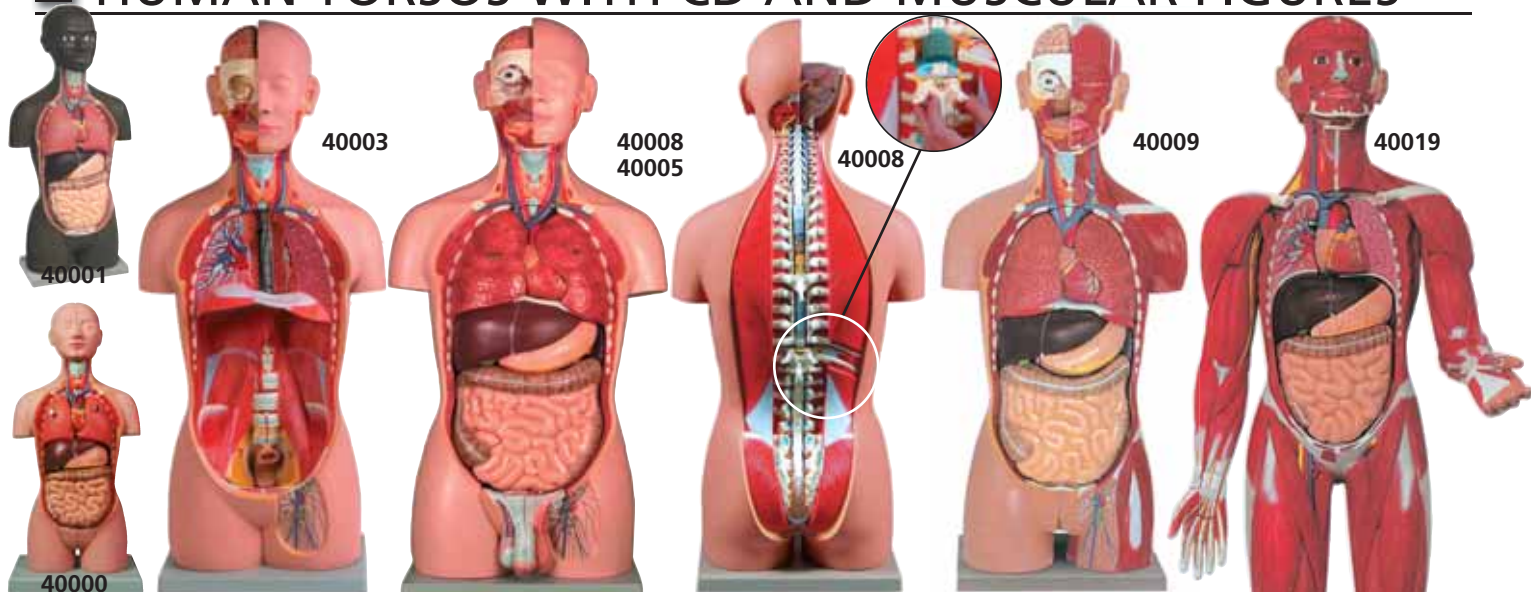

GIMA code	HUMAN TORSOS *SUPPLIED WITH CD ROM GUIDE	Size	Weight	Parts
40000	MINI TORSO	20x15xh45 cm	2.1 kg	16
40001	MINI TORSO - african	20x15xh45 cm	2.1 kg	16
40003	TORSO UNI SEX *	23x33xh90 cm	9 kg	16
40005	TORSO DUAL SEX*	23x33xh90 cm	9.3 kg	25
40008	TORSO DUAL SEX OPENBACK*	23x33xh90 cm	9.3 kg	27
40009	MUSCULAR TORSO DUAL SEX OPENBACK*	23x33xh90 cm	10 kg	28
40019	MUSCULAR FIGURE	30x33xh87 cm	5.3 kg	30



This CD-ROM Guide greatly extends the educational value of the anatomical torsos by identifying hundreds of structures that are not included on the printed key. High-resolution digital images of torso components show the finest anatomical details of all body systems from various angles.

Some of the detachable parts of human torsos (40005-8-9):



Removable structures, of codes 40005-8-9, include the following:  
 - eye with optic nerve and extraocular muscles  
 - half of the brain - trachea - descending thoracic aorta and esophagus - right and left lungs (two parts each)- liver with gallbladder - half of one kidney - two part heart - stomach dissected in two parts (not for 40005) - pancreas, duodenum and spleen - small and large intestines - male and female urogenital systems (4 parts each), (on 40009 female system is in 3 parts and provided of detachable fetus) - thoracic vertebra (T12) with spinal cord (code 40008 and 40009 only).

Detachables parts of human muscular figure 40019:



## HEAD MUSCULATURE

### • 40015 HEAD/NECK MUSCULATURE

Size: 37x23x46 cm  
 - 3.1 kg - 1 part - life size

Superficial and deep musculature are well represented as are the pathways of the subclavian and carotid arteries

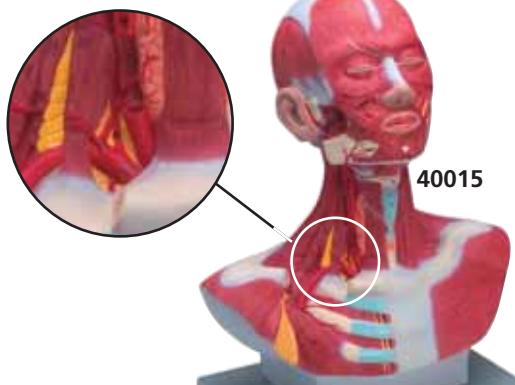

40015

## MUSCLES: SHOULDER, ARM, LEG

### • 40016 SHOULDER MUSCLE

Size: 23x19x11 cm - 435 g  
 1 part - 1X

Mounted on a base with stand



40016

This model illustrates in great details the muscles, ligaments and bones of the shoulder. Through different muscles section it is possible to observe the deep musculature to the bone.

### • 40017 ARM MUSCLE

Size: 74x20x12 cm - 1.9 kg  
 - 7 parts



40017

This 7-part life size model shows, in great detail, the anatomical structure of the arm, complete with superficial and deeper muscles, vascular structures, nerves and ligaments. The hand and the shoulder are also well represented. The following parts are removable:  
 - deltoid muscle  
 - biceps muscle  
 - triceps muscle  
 - long palmar muscle with radial flexor muscle of wrist  
 - brachioradial muscle  
 - radial extensor muscle of wrist  
 - palmar aponeurosis

### • 40018 LEG MUSCLE

Size: 110x19x14.5 cm - 5.1 kg  
 13 parts

Mounted on a base with stand

This 13-part model shows, in great detail, the anatomical structure of the leg, complete with superficial and deeper muscles, vascular structures, nerves and ligaments.

The following parts are removable:

- sartorius
- long head of biceps
- gluteus maximus
- soleus
- gastrocnemius
- gluteus medius
- gracilis
- semitendinosus and semimembranosus
- rectus femoris
- extensor digitorum longus
- sole of foot
- tensor fasciae latae

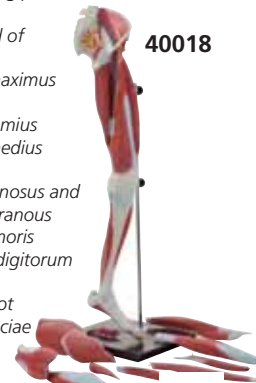

40018

## SKELETONS

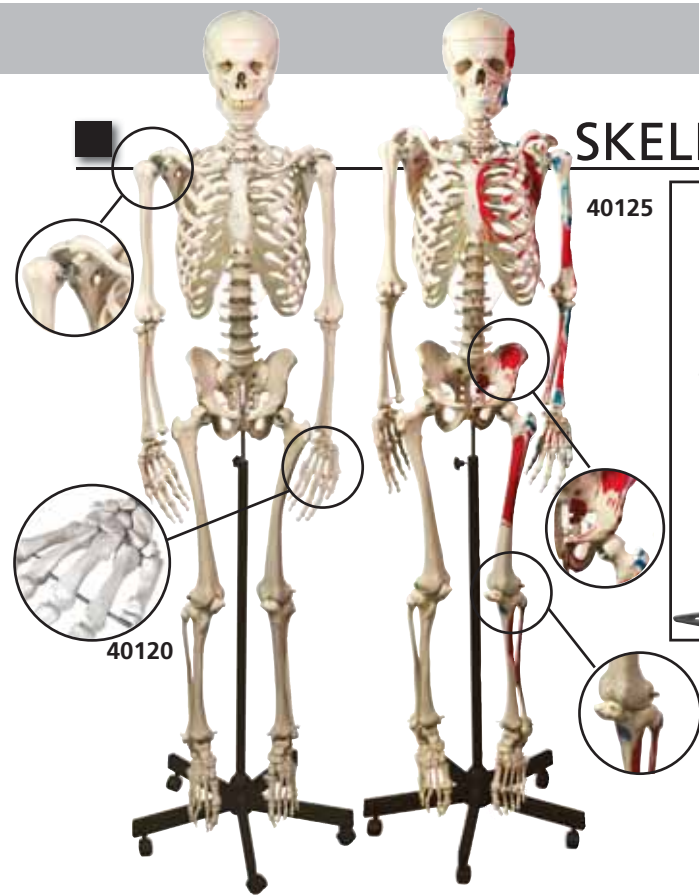

**40115 MINI SKELETON**

Height: 80 cm Weight: 1.5 kg. This 1/2 life size model shows the anatomy of the human skeleton in high detail. The skull can be disassembled into 3 parts: skullcap, base of skull and mandible. All the main joints are articulated. Arms and legs can be removed easily. Mounted on a stand for hanging.

**40120 HUMAN SKELETON**

Height: 170 cm. Weight: approx 10 kg. This model is a replica of a life size human skeleton and shows all the skeleton parts in high detail. It's hand-assembled to provide intricate details and long-lasting durability. The main joints are articulated; the upper and lower limbs can be removed easily. The following parts are detachable: Calvarium, Skull, Jaw, Arms, Legs. Supplied with 5-caster roller stand.

**40125 MUSCULAR HUMAN SKELETON**

Same as code 40120 but with the left side of the skeleton showing the point of origin (red) and the point of insertion (blue) of the muscles.

## VERTEBRAL COLUMNS

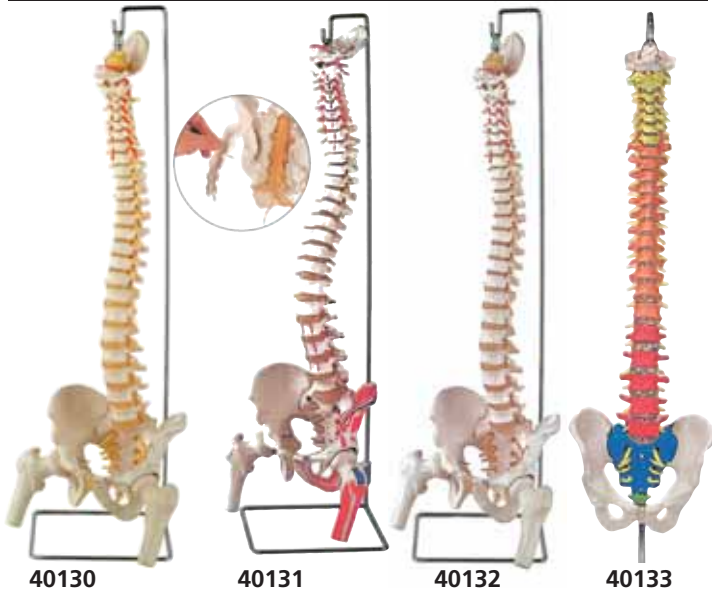

**FLEXIBLE VERTEBRAL COLUMNS**

Fully flexible life size vertebral columns consisting of the occipital plate, cervical, thoracic and lumbar vertebrae, sacrum, coccyx, complete pelvis with symphysis, removable femur heads (only 40130,31,32).

All models also feature representation of the vertebral arteries, spinal nerve branches, and a prolapsed L3-L4 intervertebral disc.

On 40131 the left side of the skeleton shows the points of origin (red) and the point of insertion (blue) of the muscles. On 40131 and 40132 the sacral crest and coccyx are removable to show the sacral section of the spinal cord and associated nerve branches.

On 40133 the various regions of the spinal column are colour coded for easy identification.

GIMA code	FLEXIBLE VERTEBRAL COLUMNS	Size cm	Weight	Magnif.
40130	VERTEBRAL COLUMN with femur heads	95x20x20	3 kg	1X
40131	VERTEBRAL COL with femur + muscle	95x20x20	3 kg	1X
40132	VERTEBRAL COL with femur + open sacrum	95x20x20	3 kg	1X
40133	SPINAL COL with colour coded regions	98x23x23	970 g	1X

## KNEE AND SHOULDER

**40140 SHOULDER JOINT**

Size: 29x12x12cm - 560g - 1 part - 1X  
Mounted on stand.

**40145 KNEE JOINT**

Size: 12x12x31cm - 440g - 1 part - 1X

The life size model represents a functional model of knee joint with lateral ligaments, meniscus and patellar ligament.

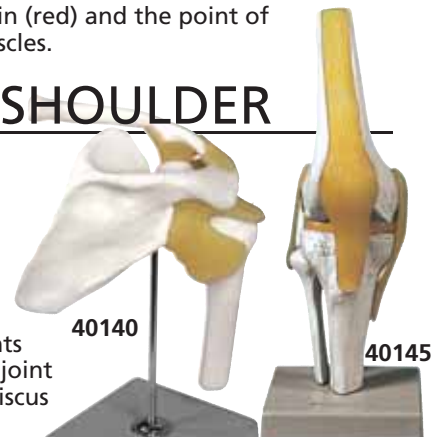

## SKELETAL SYSTEM

**Advanced osteoporosis model.**

Shows 3 vertebrae: one healthy vertebra, one vertebra with pathological changes at first stage, one vertebra with pathological changes at advanced stage.



**Cervical spinal column** consists of 7 cervical vertebrae with intervertebral discs, occipital plate, cervical nerves, vertebral arteries, spinal cord and brain stem.

**Thoracic spinal column** consists of 12 thoracic vertebrae with intervertebral discs, thoracic nerves and spinal cord.

**Lumbar spinal column with sacral and coccyx bones.** It consists of 5 lumbar vertebrae with intervertebral discs, lumbar nerves and spinal cord. The sacral crest and coccyx are removable.

**3 lumbar vertebrae with hernia and prolapsed intervertebral disc.** Shows 3 lumbar vertebrae with spinal nerves, dura mater and 2 intervertebral discs affected by lateral and medial hernia.

GIMA code	SKELETAL SYSTEM	Size cm	Weight	Magnif.
40136	CERVICAL SPINAL COLUMN	12x12x22	350 g	1X
40137	THORACIC SPINAL COLUMN	12x12x40	600 g	1X
40138	LUMBAR SPINAL COLUMN	12x12x36	800 g	1X
40180	HERNIA PATHOLOGY	16.5x12x26	300 g	1X
40185	ADVANCED OSTEOPOROSIS	12x12x15	200 g	1X

## HUMAN SKULLS - 3 PARTS



40160



40161



40162



40163

### Numbered skull (40161)

Significant structures are numerated

### Coloured skull (40162)

All the bones are depicted in different colours, making this model a useful tool to study the correct position and relationship of all the structures.

### Muscular skull (40163)

The left side of the skull shows the points of origin (red) and the point of insertion (blue) of the muscles.

### MINI SKULL (40165) ½ adult natural size

It depicts all structural details of the skull. It can be disassembled into skullcap and base of skull.

Articulated mandible.

Life size human skull reproduction with all details, made in PVC. Removable skull cap and articulated mandible.



40165

GIMA code	HUMAN SKULLS	Size cm	Weight g	Magnif.
40160	HUMAN SKULL	22x14x16	950	1X
40161	HUMAN SKULL - numerated	22x14x16	950	1X
40162	HUMAN SKULL - coloured	19.5x17x21.5	950	1X
40163	HUMAN SKULL - muscular	18x17x21	875	1X
40165	MINI SKULL	11x11x16.5	150	0.5X

## DENTAL MODELS

### • 40206 DECIDUOUS TEETH

Size: 9x9x10 cm - weight: 85 g. Mounted on base with stand.

This life size model shows the upper and lower jaw of a 5 year old child. The lower jaw is movable to reproduce the natural chew. The model exposes the arrangement of the young teeth.

### • 40205 PERMANENT TEETH

Size: 11x11x12 cm - weight: 170 g. Mounted on base with stand.

This life size model shows the upper and lower jaw of an adult. The lower jaw is movable to reproduce the natural chew. The model exposes the complete set of permanent teeth with roots and nerves fibres.



40206

40205



### • 40210 LOWER JAW

Size: 35x18x31 cm - weight: 1130 g  
Mounted on base with stand.

This 3X life size model is divisible into 6 parts to show all the characteristics of an adult half mandible. A portion of the jaw can be removed to show the roots of the teeth and the internal structure of the bone. Canine and molar teeth can be removed and dissected longitudinally to observe the tooth roots, pulp and nerves.



### • 40212 DENTAL PATHOLOGY MODEL

Size: 6x4.5x11 cm - weight: approx. 100 g

This 4X life size model shows the process of dental caries in its progressive stages. The tissues forming the tooth (enamel, dentine and pulp) are shown, along with the way in which they are affected by the caries process.

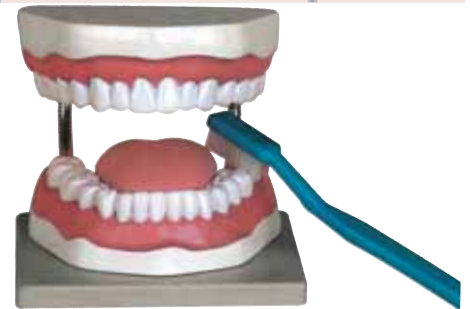

### • 40200 ORAL HYGIENE

Size: 12x16x22 cm - weight: 1 kg  
Mounted on base.

A 3X life size model useful to teach the correct way to brush teeth. A giant toothbrush is included.



### • 40213 SET 3 TEETH: INCISOR, CANINE, MOLAR

Size: 33x33x11 cm - weight: 700 g

5-part model includes representations (10X life size) of human incisor, canine and molar teeth. The canine and molar can be divided into 2 parts each, showing internal features (dentine, enamel, cement and pulp).



### • 40214 LOWER MOLAR WITH CARIES

Size: 11x11x19.5 cm - weight: approx. 250 g  
Mounted on base with stand.

This 1-piece model is approximately 10X life size; it shows the most important dental pathologies, including dental caries, pulpitis, gingivitis and periapical periodontitis.



### • 40211 DENTAL CARIES

Size: 12x6x6 cm - weight: approx. 300 g

This model, composed of 7 parts, is 4X life size. It consists of 3 teeth, seated in their sockets, showing the progressive deterioration of tooth structure by dental caries. The first tooth shows the caries in the enamel. In the second tooth, the caries spreads through the dentine. In the third tooth, the pathology affects the pulp, jeopardizing the vitality of the tooth.

# VALUE HUMAN ANATOMY MODELS

**HUMAN SKULLS - 3 parts**

A detailed reproduction of a life size human skull with all structural details. The mandible is articulated, the skullcap is removable to show internal details. All of the joints, sutures, fissures, foramina and processes are portrayed with utmost accuracy.



• 40155 HUMAN SKULL 1X - 3 parts



• 40156 HUMAN SKULL 1X NUMERATED - 3 parts



• 40157 HUMAN SKULL 1X COLOURED - 3 parts



Giant toothbrush is included

• 40199 ORAL HYGIENE MODEL - 3X

Fully flexible life size vertebral columns consisting of the occipital plate, cervical, thoracic and lumbar vertebrae, sacrum, coccyx, complete pelvis with symphysis, removable femur heads



• 40127 FLEXIBLE VERTEBRAL COLUMN with femur heads



A functional model of knee joint with lateral ligaments, meniscus and patellar ligament.

• 40144 KNEE JOINT

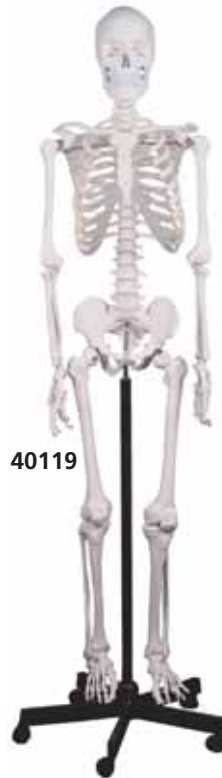

40119



40124

Life size human skeletons show all the skeleton parts in high detail. The main joints are articulated; the upper and lower limbs can be easily removed. The following parts are detachable: Calvarium, Skull, Jaw, Arms, Legs. Supplied with 5-caster roller stand.

Height: 180 cm  
Weight: approx 10 kg



40124

• 40119 HUMAN SKELETON

• 40124 HUMAN MUSCULAR SKELETON



• 40139 SHOULDER JOINT

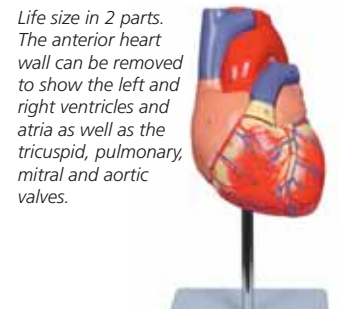

• 40069 HEART 1X - 2 parts

Life size in 2 parts. The anterior heart wall can be removed to show the left and right ventricles and atria as well as the tricuspid, pulmonary, mitral and aortic valves.



• 40070 HEART 3X - 3 parts



40070

Shows internal structures including the cardiac valves and the comparative morphology of the right and left ventricles.



Assembled

• 40028 EYE 6X - 6 parts



40028

Disassembled

Cornea, iris, lens and vitreous body can be removed.



• 40038 EAR 3X - 3 parts

These models show the external, middle and inner ear. The eardrum with malleus, incus and stapes are removable. Also cochlea and labyrinth with vestibular and cochlear nerves and 2 bones sections (40039 only) that define the middle and inner ear are removable.



• 40039 EAR 3X - 5 parts

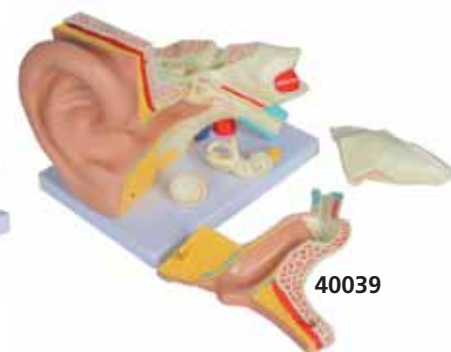

40039



STREP-A RAPID TEST

page 11



HOLLOWWARE

page 29-50



PATIENT AIDS

page 87-96



MULTIFUNCTIONAL TROLLEYS

page 117-123



SIGMA F.O. OTO-OPHTHALMOSCOPIES

page 212



ECG AND ACCESSORIES

page 269-279



MULTIPARAMETER MONITORS

page 288-292



EMERGENCY KITS

page 331



3M DRESSINGS

page 337-346



# GIMA

GIMA S.p.A. - Via Marconi, 1 - 20060 Gessate (MI) - Italy  
Tel. +39 02 953854209/221/225 - Fax: +39 02 95380056  
E-Mail: [export@gimaitaly.com](mailto:export@gimaitaly.com) [www.gimaitaly.com](http://www.gimaitaly.com)